

## CONTENTS

<b>1.</b>	<b>OVERVIEW AND ACKNOWLEDGMENTS.....</b>	<b>3</b>
<b>2.</b>	<b>PRODUCT FEATURES.....</b>	<b>4</b>
<b>3.</b>	<b>CONNECTORS AND JUMPERS.....</b>	<b>6</b>
<b>4.</b>	<b>DRIVER INSTALLATION.....</b>	<b>8</b>
4.1.	DOS Installation.....	8
4.2.	Win95/98/ME Installation.....	8
4.3.	Win95/98/ME Un-installation.....	9
4.4.	Windows NT 4.0 Installation.....	9
4.5.	Win2000 Installation.....	10
<b>5.</b>	<b>WINDOWS APPLICATIONS.....</b>	<b>12</b>
5.1	Audio Rack.....	12
5.1.1.	Control Center.....	13
5.1.2.	CD Player.....	14
5.1.3.	MIDI Player.....	17
5.1.4.	MP3/Wave Player.....	20

5.1.5. Mixer.....25

5.2 Multi-Channel Audio Demo.....28

**APPENDIX A - THE 4 SPEAKERS SYSTEM.....37**

**APPENDIX B - C3D HRTF POSITIONAL AUDIO.....39**

**APPENDIX C - SOLUTIONS FOR MINI DISC.....45**

# 1. Overview and Acknowledgments

This PCI Audio Adapter offers a new generation PCI audio solution: it utilizes the state-of-the-art CRL® 3D Audio technology(HRTF 3D positional audio), and supports Microsoft® DirectSound® 3D and Aureal®'s A3D® interfaces. Better yet, it supports two / four speakers and DLS based (DownLoadable Sound) wave table music synthesizer which supports the DirectMusic®. Besides being legacy audio SB pro® compatible and providing professional SPDIF IN/OUT non-distortion digital interface, it also supports MPU-401 interface, dual game ports, etc. What we provide at the side of the sound card are line-in/rear speaker jack, microphone jack, audio output jack, SPDIF/OUT jack, and 15pin D-SUB multiplexed joystick/MIDI connector.

## Trademark Acknowledgments

Microsoft, Windows, DirectSound 3D, and DirectMusic are trademarks of Microsoft Corporation. Sound Blaster is a trademark of Creative Technology, Ltd. Aureal is a trademark of Aureal Inc. A3D is a registered trademark of Aureal Inc. All other trademarks and registered trademarks mentioned in this manual are the property of their respective holders and are hereby acknowledged.

## FCC Compliance Statement

Certified to comply with the limits for a Class B computing device according to Subpart J or Part 15 of FCC rules.

Information in this manual is subject to change without notice.

## 2. Product Features

### • Special Features

1. PCI Plug and Play (PnP) bus interface, 32 bit PCI bus master.
2. Full duplex playback and recording, built-in 16 bits CODEC.
3. HRTF 3D positional audio, supports both DirectSound 3D® & A3D® interfaces, supports earphones, two and four channel speakers mode.
4. Support Windows 98 /Windows 2000 and Windows NT 4.0.
5. Built-in 32 OHM Earphone buffer.
6. MPU-401 Game/Midi port and legacy audio SBpro support.
7. Downloadable Wave Table Synthesizer, supports Direct Music®.

### • Digital Audio (SPDIF IN/OUT)

1. Up to 24 bits stereo 44KHz sampling rate voice playback/recording.
2. Full duplex playback and recording, 120dB audio quality measured.
3. Auto detectable SPDIF/IN signal level from 0.5V to 5V.

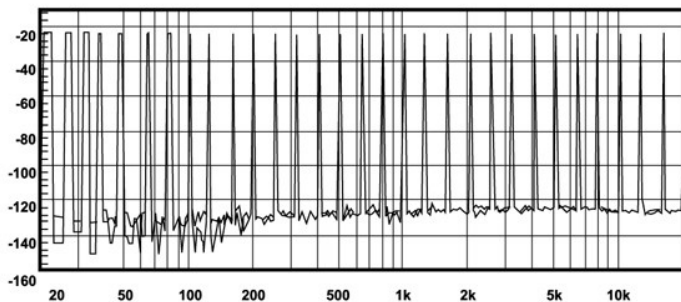

120dB audio quality in playback, recording, and bypass modes.

- **Stereo Mixer**

1. Stereo analog mixing from CD-Audio, Line-in
2. Stereo digital mixing from Voice, FM/Wave-table, Digital CD-Audio
3. Mono mixing from MIC and software adjustable volume

- **Game and Midi Interface**

1. Fully compatible with MPU-401 Midi UART and Sound Blaster Midi mode/Standard IBM PC joystick/game port (dual channels)

### 3. Connectors and Jumpers

Connector	Function
J1	Analog CD/IN Port ( Signals: L-G-R-G )
J2	Analog CD/IN Port ( Signals: R-G-G-L )
J3	AUX-IN Port ( Signals: L-G-G-R )
J4	SPDIF ( Signals: O-G-I-G )
CN1	OPTICAL SPDIF- I/O
Line-IN	LINE-IN Connect with the audio output port of stereo
Mic-IN	Connect with the Microphone ( Mono )
Front-Speaker	Output to speakers with the amplifier or earphones or AUDIO-IN of home stereo
Rear-Speaker	Connect with the rear speakers while four channel speakers mode enabled
Center/Sub Woofer-Speaker	Connect with the Cen/Sub speakers while 5.1 channel speakers mode enabled
SPDIF-OUT	Connect with Mini Disc, LD Player or AC3 Amplifier
GAME/MIDI	Connect with Joystick or devices that use MIDI interface



## 4. Driver Installation

### 4.1. DOS Installation

Before beginning the installation, please make sure that your hard disk has sufficient space(min. 4MB). Insert the Driver CD into the CD-ROM Drive.

1. Change directory to PCI audio DOS drivers folder (ex.

D:\DOSDRV) at DOS prompt, and type:

*INSTALL* [Enter]

2. Type DOS utilities path you want to install the file in.
3. Program will expand the file to the path you've specified.
4. Install program will add initial drivers into AUTOEXEC.BAT file.

### 4.2. Win95/98/ME Installation

1. Click "Start" at Windows bottom left corner.
2. Select "Run"
3. Key in the drive and path for Windows 95/98 drivers/application installation program; for example, "D:\W95-98\SETUP.EXE"
4. Click "OK" to start the applications installation procedure, and follow the on-screen instructions to finish the installation.
5. When all the application software has been installed,

please shut down Windows 95/98 system, and reboot your system for new drivers installation. System will install device drivers automatically.

### **4.3. Win95/98/ME Un-installation**

1. Click "Start".
2. Select "Program."
3. Find "Uninstall device drivers and applications" program in PCI audio applications.
4. Run it.
5. Follow the on-screen instructions to uninstall the device drivers or applications.

### **4.4. Windows NT 4.0 Installation**

We recommend that you install Windows NT 4.0 before you install this PCI audio card, and you not install any other sound card device drivers in your current system.

1. Click "Start", move the highlight bar to "Setting", and select the "Control Panel".
2. Double-click "Multimedia".
3. Select "Devices", and press "Add".
4. Select "Unlisted or Updated Driver" in "List of Drivers".
5. Specify the drive and the path where NT drivers are in (such as D:\NT40\DRV).
6. Select "C-Media CM8738," and press "OK".
7. Select proper I/O value.
8. Press "OK."
9. Restart the system when being asked.
10. Now, you have already installed the PCI Audio Adapter

under Microsoft Windows NT 4.0 successfully. If you want to install the Windows applications, continue the following steps:

11. Click "Start".
12. Select "Run".
13. Key in drive and path for Windows NT application installation program; for example, "D:\NT40\APP\SETUP.EXE"
14. Click "OK" to start the installation procedure, and follow the on-screen instructions to finish the installation. When all of application software has been installed, shut down the Windows NT system, then reboot your system.

## 4.5. Win2000 Installation

We recommend that you install Microsoft Windows before you install this PCI sound card, and you not install any other sound card device drivers in your current system.

1. Power off your system, install the PCI sound card, audio cable, speaker, microphone, and insert driver CD into the CD-ROM drive.
2. Turn on the computer, and enter the Microsoft Windows system.
3. You will see a dialog box prompt like this:  
"This wizard helps you install a device for a hardware device  
To continue, click "Next.". Click "Next" to go on the procedures.
4. When "Install Hardware Device Drivers" dialog box is shown, select "Search for a suitable driver for my device," then click "Next button."

5. Click "Specify a location" to specify the driver path.
6. When "C-Media CM8738 Audio Driver(WDM)" is found, click "Finish".

Now, system is installing the new device driver automatically.

## 5. Windows Applications

### 5.1 Audio Rack

By means of a user-friendly interface(as easy as operating your home stereo system), this PCI audio rack provides you with the control over your PC's audio functions, including the advantage of four speakers mode enable/disable, and perfect digital sound ( SPDIF ) input /output control.



## 5.1.1. Control Center

This Audio Rack consists of several major components:

**Control Center:** Controls the display of the PCI Audio Rack components.

---



**CD Player** can play standard audio CDs, and allow you to create your favorite song play list.

**MIDI Player** can play MIDI files, \*.mid/\*.rmi, and allow you to create your favorite song play list.

**MP3/Wave Player** can play mp3, wave, CDDA, and MPEG-1 files. It provides EAX and equalizer to improve the sound effect when you playback the audio files. If you want to sing a song, MP3/Wave Player also provides a Karaoke function. MP3/Wave Player can record input signals and save it in a wave file as well.

**Mixer** controls the volume level of your audio inputs and outputs.

### Showing or Hiding Audio Rack Components

To show or hide a component from the display, click the

component button(s) listed on the top.

## 5.1.2. CD Player

**CD Player:** Plays standard audio CDs, and allows you to create your favorite song play list.



**Current Track field** shows the number of the current selection of CD tracks.

**CD title and track name field** shows CD title and track name. You can modify CD title and track name in [Play list] function.

**Total length field** displays the total length of the current track in minutes and seconds.

**Playback time field** displays the current playback time.

### Button Function



**Play list:** You can select or remove tracks of audio CD into play list. The title of CD and the name of tracks can be modified as well. Play list dialog will save and show them automatically when you want to

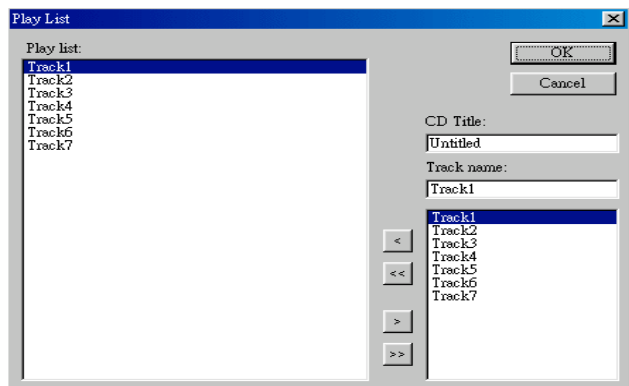

play the same CD.



**Previous song:** Loads the previous track of play list. If current track is the first track, the last track will become the current track.



**Next song:** Loads the next track of play list. If current track is the last track, the first track will become the current track.



**Playback:** Starts to playback the current track.



**Pause/Restart:** Pauses or restarts the current playback action.



**Stop:** Stops playback.



**Reverse 10 seconds:** Causes the current playback time to 10 seconds backward.



**Forward 10 seconds:** Causes the current playback time to 10 seconds forward.



**Loop:** Playbacks the tracks over and over.



**Eject:** Opens the CD-ROM in order to change the audio CD.



**Setting:** Selects the CD-ROM drive which analog output is connected to the Analog-CD in of your sound card. If your CD-ROM does not connect the analog CD input wire, please select "Using CD-DA" option.

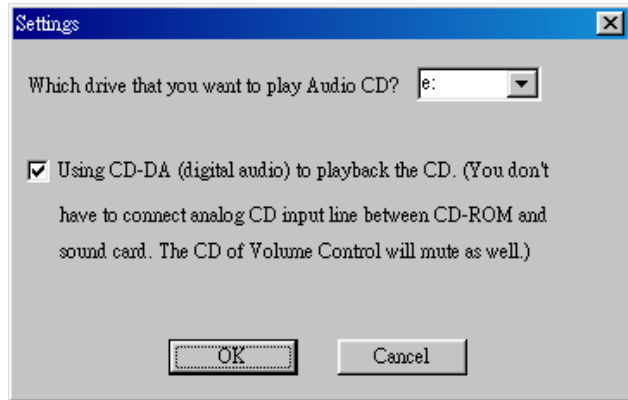

**Help:** Shows the help screen for detailed button function descriptions.



**About:** Shows software version and copyright information.



**Exit:** Stops running CD Player.

### 5.1.3. MIDI Player

**MIDI Player** can play MIDI files, \*.mid/\*.rmi, and allow you to create your personal song play list.



**Current file field** shows the number of the current selection of MIDI files.

**File name field** shows the file name.

**Total length field** displays the total length of the current selected file in minutes and seconds.

**Playback time field** displays the current playback time.

#### Button Function



**Play list:** allows you to insert, remove, and record the MIDI files into and from the play list. You can save the play list into a file as well.

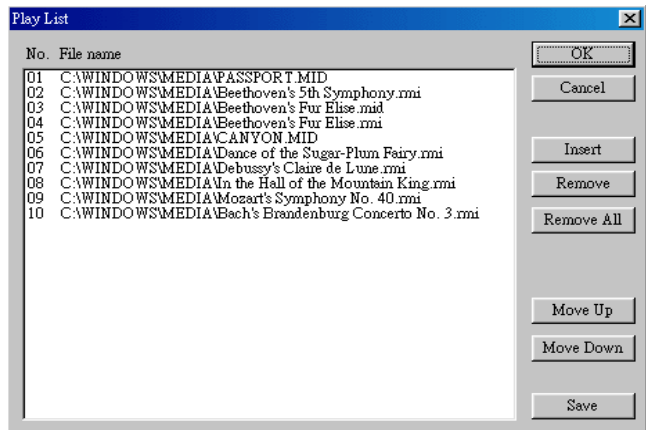



**Previous song:** Loads the previous MIDI file of play list. If current file is the first MIDI file, the last one will become the current selection.



**Next song:** Loads the next MIDI file of play list. If current file is the last one, the first file will become the current selection.



**Playback:** Starts to playback the current MIDI file.



**Pause/Restart:** Pauses or restarts the current playback action.



**Stop:** Stops playback.



**Reverse 10 seconds:** Causes the current playback time to 10 seconds backward.



**Forward 10 seconds:** Causes the current playback time to 10 seconds forward.



**Loop:** Playbacks the MIDI files of the play list over and over again.



**Setting:** Selects the output device you want to use to playback the MIDI files.

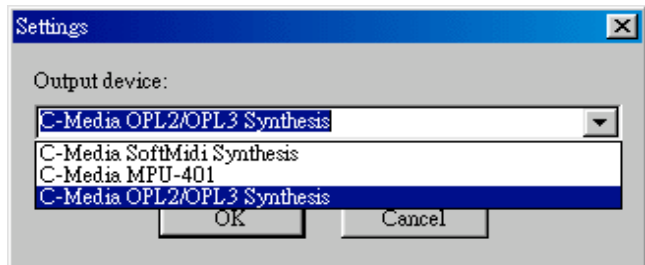



**Help:** Shows the help screen for detailed button function descriptions.



**About:** Shows software version and copyright information.



**Exit:** Stop running MIDI Player.

## 5.1.4. MP3/Wave Player

**MP3/Wave Player** can play mp3, wave, CDDA, and MPEG-1 files. It provides EAX and equalizer to improve the sound effect when you playback the audio files. If you want to sing a song, MP3/Wave Player also provides a Karaoke function. MP3/ Wave Player can record input signals and save it into a wave file as well.



**Current file field** shows the number of the current selection of audio files of the play list.

**Frequency display field** shows the frequency distribution.

**Total length field** displays the total length of the current selected file in minutes and seconds.

**Playback time field** displays the current playback time.

**File name and status field** displays the file name, audio format, sound effect selection, playback mode, Karaoke mode, and SPDIF status.

### Button Function



**Play list:** Play list allow you to insert, remove, and record the audio files into and from the play list. The audio files include wave, MP3, CDDA, and MPEG-1 encoding files. Some CD-ROMs do not support read the sectors of tracks of Audio CD in real time; hence, those CD-ROMs are not suitable to use CDDA function to playback the Audio CD.

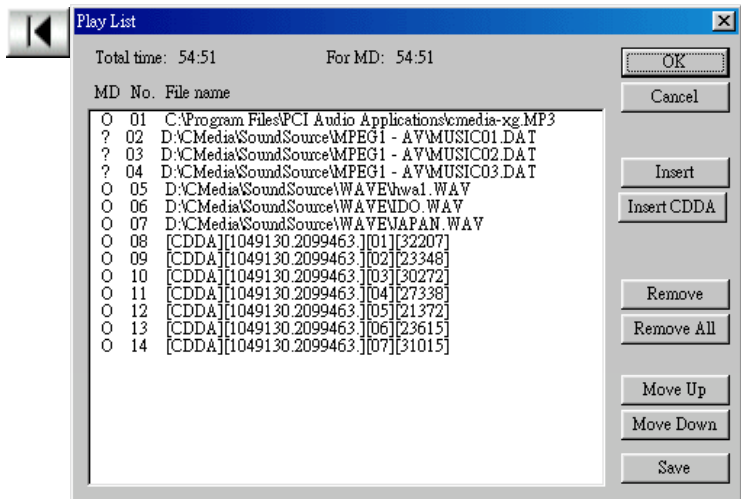

**Previous song:** Loads the previous audio file of play list. If current file is the first file, the last one will become the current selection.



**Next song:** Loads the next audio file of play list. If current file is the last one, the first file will become the current selection.



**Playback:** Starts to playback the current audio file.



**Pause/Restart:** Pauses or restarts the current playback action.



**Stop:** Stops playback.



**Reverse 10 seconds:** Causes the current playback time to 10 seconds backward.



**Forward 10 seconds:** Causes the current playback time to 10 seconds forward.



**Sound Effector:** You can use this function to modify the special effect of the song being played. Currently, these effectors can only be used for 44.1 KHz, 16 bits format. For Windows NT users, we do not support the Karaoke and MCI 4-speaker functions.

For 039 chip and later, the 4 Channels/EAX function will be change to 6 Channels/EAX in order to support 6 channels playback.

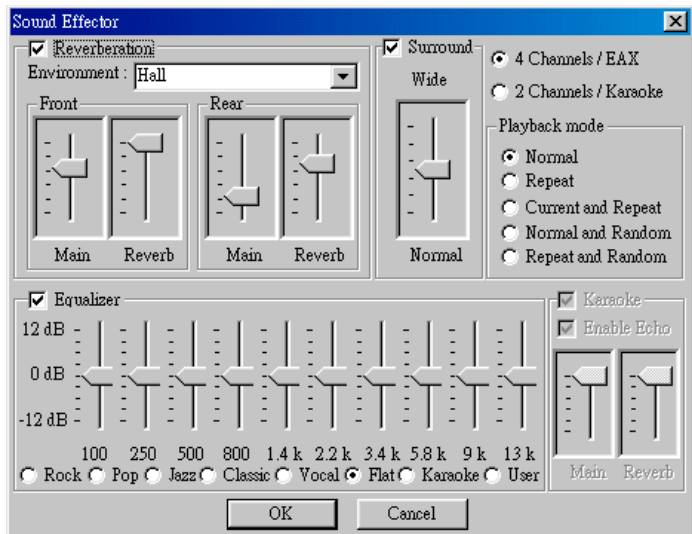

**Setting:** You can use this dialog to set the playback parameters and the status of SPDIF IN/OUT. For more information of SPDIF, please refer to the Appendixes of C and D.

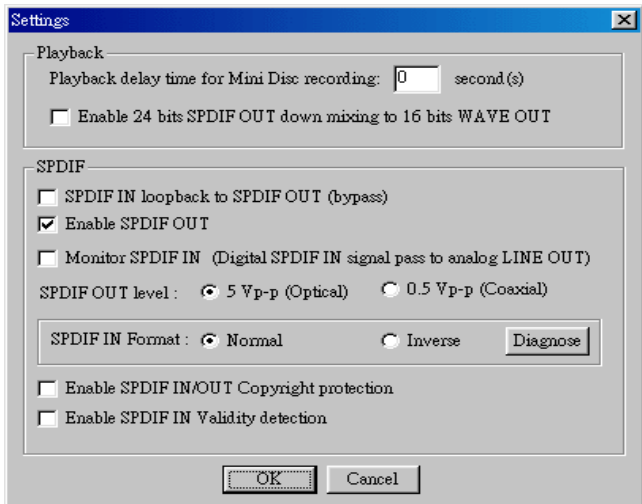

**Recording:** You can use this function to record a wave file from any recording channel.

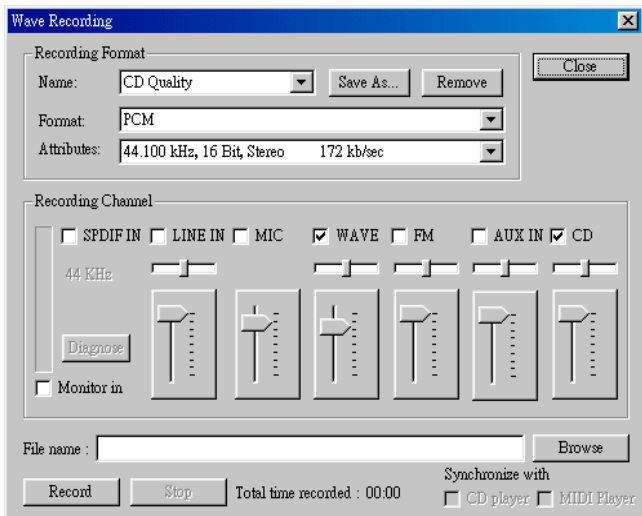



**Help:** Shows the help screen for detailed button function descriptions.



**About:** Shows software version and copyright information.



**Exit:** Stop running MP3/Wave Player.

## 5.1.5. Mixer

### Volume Control



For each output signal, a control slider controls the loudness whereas a horizontal slider controls the balance between the two speakers. The mute button can temporarily stop the output without changing slider positions. A button with a lit LED means the output is available, and vice versa. Several output signals can usually be enabled at once.

**Volume:** This is the master control for all outputs. The power of an output signal is determined by both of the volume slider and the slider for the individual output. To modify all the outputs, move the volume slider. To change individual output(s), move its(their) slider(s).

**CD:** Controls the CD drive audio input level.

**MIC:** Controls the input level of microphone.

**WAVE:** Controls wave (voice) playback levels.

**FM:** Controls the FM music play level.

**AUX IN:** Controls the Auxiliary input play level.

**MONO IN:** Controls the Mono input level.

**LINE IN:** Controls the Line-In levels.

**Multi-SPK/4Speaker:** Turn on or turn off the multi-speakers/4 speakers system. If you want to use multi-speakers/4 speakers system, please turn on this button and connect rear speakers to 'Rear-Speaker' (4 phone jacks) or 'Line-in' phone jack (3 phone jacks). For 039 chip and later, you also can connect center/subwoofer speakers to

'Center/Subwoofer' (5 phone jacks) or 'Line-in' phone jack (4 phone jacks).

**Advanced:** Controls the advanced settings.

## Recording Control



For each input signal, a control slider controls the loudness whereas a horizontal slider controls the balance between the two channels. The select button can temporarily select input signal without changing slider positions. A button with a lit LED means it is available, and vice versa.

**CD:** Controls the CD drive audio input level.

**MIC:** Controls the input level of microphone.

**WAVE:** Controls wave (voice) playback level.

**FM:** Controls the FM music play level.

**AUX IN:** Controls the Auxiliary input play level.

**LINE IN:** Controls the Line-In level.

**SPDIF IN:** Enables the recording from SPDIF in. SPDIF-in is mutually exclusive with other input signals.

**Echo:** Enables the echo effect of microphone for karaoke.

**Advanced:** Controls the advanced settings.

## Advanced

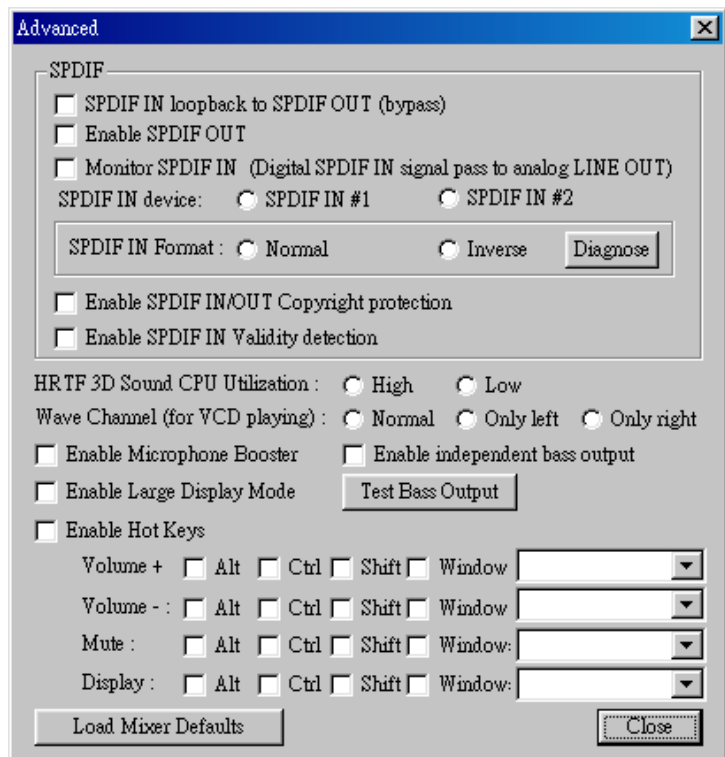

Advanced dialog provides a fully control over SPDIF IN/OUT functions. You can use these settings to connect your computer to other pieces of audio device, such as Mini Disc, amplifier, etc. Furthermore, you can enable microphone booster and hot keys. Using hot keys to control Mixer's status is an easy way, but please note that some applications may be effected if you use the same hot keys setting. For 039 chip and later, you can enable independent bass output if you have a subwoofer connected.

Please use 'Load Mixer Defaults' to change all settings to default values.

## 5.2 Multi-Channel Audio Demo

CMI8738 PCI-Based C3DX Audio Chip provides many advanced functions, such as:

- HRTF-based CRL<sup>®</sup> 3D extension positional audio; API compatible with Microsoft<sup>®</sup> DirectSound<sup>®</sup> 3D and Aureal<sup>®</sup> A3D API. Supports rear side speakers; C3DX positional audio in 4 CH speakers mode. (5.1 CH, DVD AC-3<sup>®</sup> home theater available).
- EAX<sup>™</sup> (Environment Audio eXtention).
- KARAOKE ascending/descending keys, Echo.
- Supports Center/Subwoofer side speakers. (for 039 chip and later)

To let everyone get familiar with and avail himself/herself of the above functions, we design a user-friendly interface(Multi-Channel Audio Demo) which provides the following features:

1. 4 CH speakers mode, including Demo1 and Demo2.
2. EAX<sup>™</sup> (Environment Audio eXtention).
3. HRTF-based CRL<sup>®</sup> 3D extension positional audio.
4. KARAOKE ascending/descending keys, Echo , and microphone ascending/descending keys.
5. 6 CH speakers mode, including Demo1 and Demo2. (for 039 chip and later)

### Connection of speakers and microphone



Before running this demo program, you have to connect the speakers and the microphone to the correct phone jacks. Generally speaking, there are four ways for hardware connection (sound card and motherboard):

1. Four phone jacks (most sound cards belong to this)

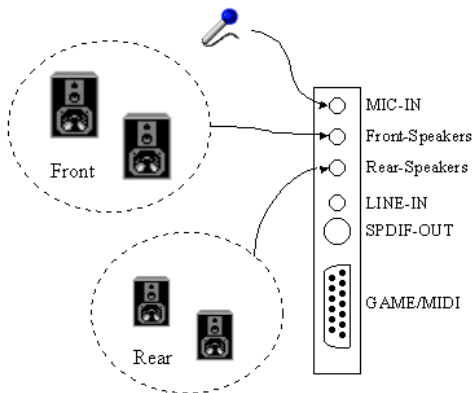

2. Five phone jacks (most sound cards belong to this) (for 039 chip and later)

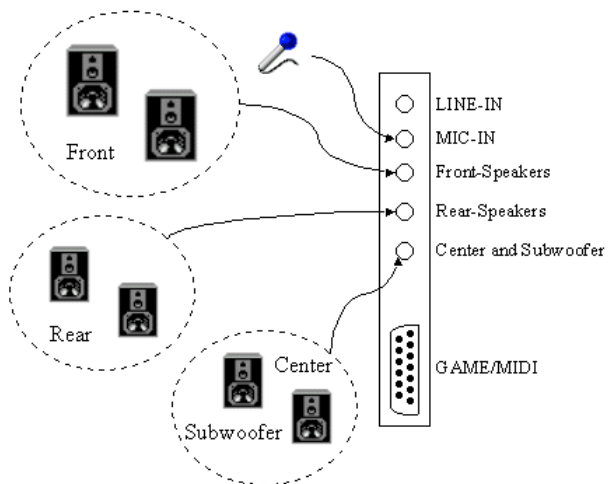

## How to enable 4 speakers/Multi-SPK

You have to open the "Mixer" program and enable the "4-Speaker" or "Multi-SPK" mode to let the audio driver recognize your rear or center/subwoofer speakers, and have the front/rear/center/subwoofer speakers work. The audio driver will activate the audio chip to output different sounds from the front/rear/center/subwoofer speakers based on different playback formats. The following is the "4-Speaker" / "Multi-SPK" console. Left-click the mouse to activate the output mode. As you can see, the "4-Speaker"/"Multi-SPK" mode is not enabled here(the light is dim):



## How to adjust the volume of microphone

You have to use the microphone when availing yourself of the "Echo" function. If the microphone is on and is very close to the speakers, it will cause feedback between the two. Also, unusual high frequencies or buzzing sounds might be heard from the speakers. To avoid this, you have to adjust the volume of microphone in both recording and playback. Sometimes you might have to adjust main and Wave volume as well. Please left-click the mouse to adjust the microphone(MIC) in both Volume and Recording Control.





## Test Your Speakers Connection

To make sure that the front and the rear speakers are correctly connected, you can use the following program to testify individual speaker output. Move cursor to whichever speaker you want to test and left-click the mouse. If the setup is correct, you can hear music coming from that speaker alone. Each output music is different for distinction.

The Center and Subwoofer speakers are only supported for 039 chip and later.



## Demonstrations

Demo1 and Demo 2 are specially design for 4-speaker system demonstration. Select Demo 1 and/or Demo 2 by left-clicking the mouse. Sit back and relax, and let the music

take control.

How was it like? Isn't it fantastic??? If you don't have 4-speaker system, hurry up and buy yourself one right away!



## EAX

Monotonous footsteps generate distinctive sound effects in different environments. In this Demo, you can hear a lady wearing high heels walk in different surroundings: generic environment, bathroom, sewer pipe, and underwater. Left-click the mouse to activate this Demo and feel the differences.



## HRTF

HRTF stands for Head Related Transfer Functions, and it is a set of audio filters varying locations of sound effects (spatial hearing cues) in three-dimension measure from listener's eardrum.

This technology and special digital signal processing are used to recreate spatial hearing cues, making our ears hear realistic and three-dimensional sounds coming from a pair of loud speakers or headphones.

When you activate this Demo, you can hear a helicopter fly around you for three times in a clockwise direction.



## Echo

Like to sing along with Karaoke? It might occur to you to use your PC for this. However, when you turn on the microphone, play the song, and ready to sing, you see that the effect is not very good. Why? Echo is the answer. To help you solve this problem, we design this demo and add the echo function in it. Please left-click the upper right of the demo screen as follows, and choose your favorite music file to play. Please note the file type has to be MP3 file.

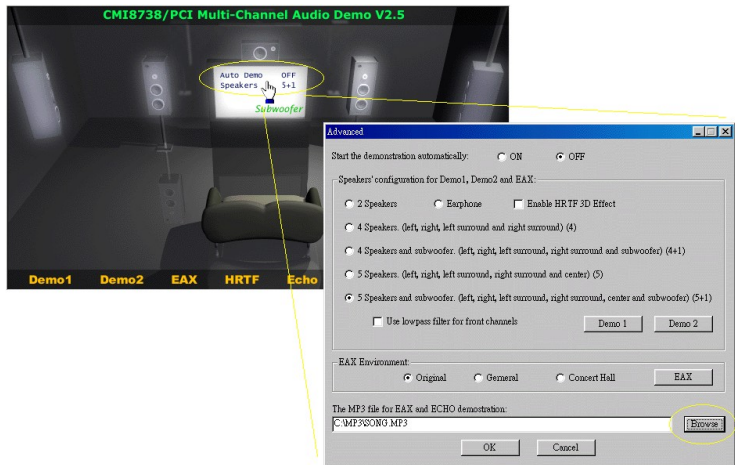

Please left-click "Echo" to activate the function. For pitch adjustment, please use ↑ and ↓ keys in your keyboard and for microphone pitch adjustment, please use "+" and "-" keys in your numeric keyboard. To resume the original, please use ← and → keys.



### How to Run the Demonstrations Automatically

To help sales persons better demonstrate these audio features, we design this Auto Demo, which can automatically run the following demos: Demo1, Demo2, EAX, and HRTF. . And also we know you have different speakers' configuration, so we provides a complete setting dialog to let you select the speakers type or earphone. To activate and inactive this function, please left-click the "Auto Demo" of the TV screen and then select its setting which is indicated as follows:

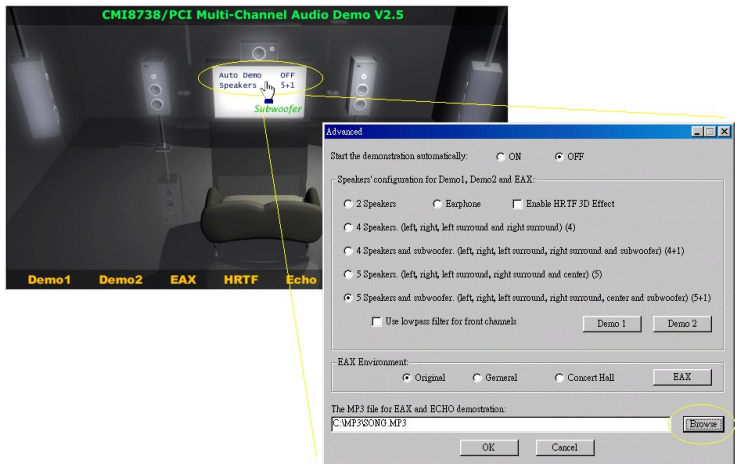

## Appendix A - The 4 Speakers System

This Audio Adapter provides 2 wave channels(front/rear), known as the 4 speakers system. When games or application programs locate the sound sources via DirectSound® 3D or A3D® interface to the listener's back, the two rear speakers will work to enhance the rear audio positional effect, so as to complement the insufficiency of using only two front speakers to emulate the audio effect. The following is the hardware installation and the software setups:

1. The installation of your front and rear speakers.

Connect the front speakers to the Line-out jack of the audio adapter, and then connect rear speakers to Line-in/Rear jack of the audio adapter. The original Line-in can be moved to Aux-in.

2. The positions of the speakers

Put your speakers the way the following picture suggests, so as to avail yourself of the optimal audio results.

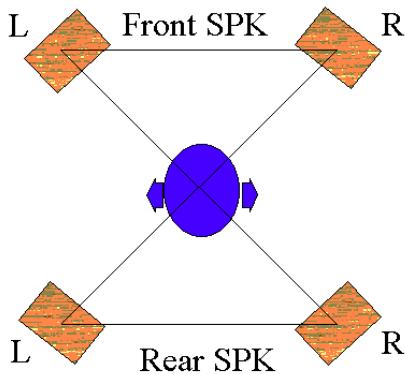

### 3. The mixer setup

There is a 4 speakers option in the volume control of the mixer. When you enable this option, it means the rear speakers are connected to Line-in/Rear jack. When Line-in/Rear jack is connected to other external Line-in sources, please DO NOT enable this option in order to avoid hardware conflicts. Regarding rear speaker option, you can turn on or turn off the output of the back speakers, and adjust the volume to have the rear/front speakers have the same output volume.

### 4. The demo

Execute the "Helicopter" demo within the C3D HRTF Positional Audio Demos of this audio adapter. When the helicopter flies behind you, the rear speakers will work. "Multi-Channel Audio Demo" is a wonderful demo of 4 speakers system as well: you can use it to find out whether or not the positions of your speakers are correct.



## Appendix B - C3D HRTF Positional Audio

The technology of C3D is licensed from CRL (Central Research Lab.), using an audio filter called Head Related Transfer Functions (HRTFs). The basic concept of C3D is, since we can hear sound three dimensionally in the real world using two ears, it must be possible to regenerate the same sound effect from two loud speakers.

### **What is HRTF ?**

HRTF (Head Related Transfer Functions) is a set of audio filters which are varying locations of sound effects (spatial hearing cues) in three-dimension measured from listener's eardrum.

Using this technology and special digital signal processing to re-create spatial hearing cues makes our ears to hear a realistic and three-dimensional sounds coming from a pairs of loud speakers or headphones.

**There are several listening cues which allow us to hear sounds three-dimensionally :**

### **(I). Spatial hearing : Primary 3D-cues**

#### **1. IAD**

The head shadowing effect creates differences in

the amplitudes of the sound signals arriving at each ear from the source. The effects of diffraction are most noticeable in the range between about 700 Hz to 8 KHz, where the A and S functions periodically converge and diverge gently. This Inter-aural Amplitude difference (IAD) is one of the primary 3D sound cues.

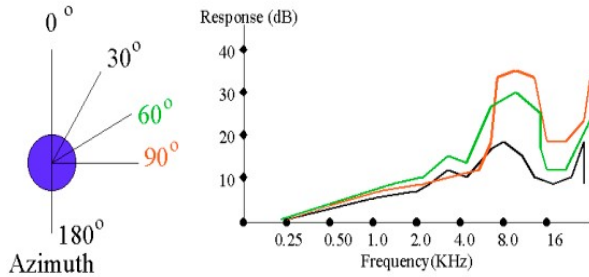

## 2. ITD

In addition to the IAD, there will be a time-of-arrival difference between the left and right ears, unless the sound source is in one of the pole positions (i.e. directly in front, behind, above and below). This is known as the Inter-aural Time Delay (ITD).

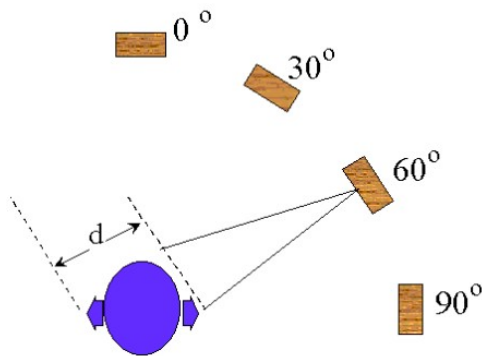

### 3. Pinna effects

It has been assumed by some researchers that the convolutions of the pinna creates the spectral features which constitute the 'height' cues. In practical experiments by Gardner, in which different parts of the pinna were occluded, and then the ability of a number of subjects to identify sound source positions at different heights was tested, it was shown that the different features all contributed by different amounts. For example, if the fossa is excluded, then height localization capability is impaired, but not totally extinguished. It would be reasonable to conclude that it is the combined effect of the pinna convolutions which creates the various localization cues, and it is not valid - or logical - to attempt to assign particular spatial capabilities with individual physical features.

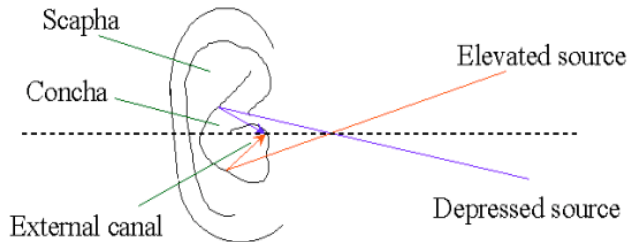

#### (II). Spatial hearing : Secondary 3D-cues (shoulder & local reflections)

In addition to the 'primary' 3D sound cues (IAD, ITD and pinna effects), there are several additional cues which do contribute to the localization capability; these will be referred to here as 'secondary' cue, and include should/torso reflections, local room reflections, and

psychological cues.

### **1. Shoulder / Torso reflections**

The presence of a torso attached to an artificial head has the effect of increasing the pressure in the vicinity of the ear up to frequencies of around 2 kHz. The effect is greater for frontal sources than lateral sources. In the experience, the presence of the torso does not appear to contribute much to spatial accuracy. However, shoulders are located very close to the ears, and their effect is greater, this time, in respect of lateral sounds. If one listens to an artificial head first without - and then with - shoulder fitments, then it is clear that the shoulders do contribute to spatial effects in certain positions. The shoulders provide a strong reflection from lateral sources, with a short path-length of around 10 cm between direct sound and reflection. The effects are most important for side-positioned sources, especially for "height" effects, where the shoulders tend to mask sources which move below about 30 degrees depression.

### **2. Local, Room reflections**

In simulations, it is clear that the incorporation of first-order simulated room reflections can help in the creation of sound images which have a "solid" nature. However, the effects - if accurately simulated - are relatively slight. Experience has shown that it is primarily the quality of the HRTFs themselves which determine the quality and solidity of the sound image. The further addition of second-order reflections does not help significantly, because in reality, there is a great number of reflections in the average room. A method which does help to recreate the acoustic experience of a room, however, is to use approximate simulations of lateral reverb, using either 2 or 4 laterally placed "virtual"

sources at, say,  $\pm 70$  degrees and 80 degrees azimuth.

- The quality of the sound image relates to the HRTFs used.
- The quality of the room image relates to addition of reflections and reverb.

### 3. Psychological cues

There are clearly psychological cues present in everyday life which work together with the audio cues to tell us about the world around us. For example, if you hear the sound of a helicopter flying, you expect it to be up in the air, not downwards. If a dog is barking nearby, you would expect it to be downwards.

How to listen to C3D sound correctly and properly?

#### 1. Use headphones to have much better effect

When you use headphones in listening, there will be less interference such as outside voices or room reflections comparing to using speakers.

#### 2. Choose correct output device

Choose the correct output device in the options of demo program in accordance with what listening device you want to listen to. Because listening through speakers must be preceded by crosstalk cancellation, if you choose the incorrect output device, there won't be any 3D positional audio effects.

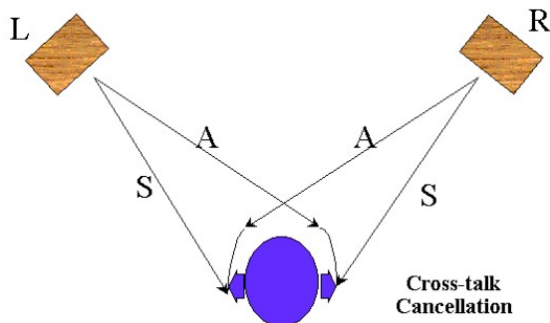

### 3. Locations of speakers

If you listen from speakers, please do not inverse the left and right speakers. They must be in equal distance from you. That means you, the left, and the right speaker must be in the topmost of a right triangle. Your position is so-called "sweet spot". In addition, the height of your ears and the height of the speakers must be the same.

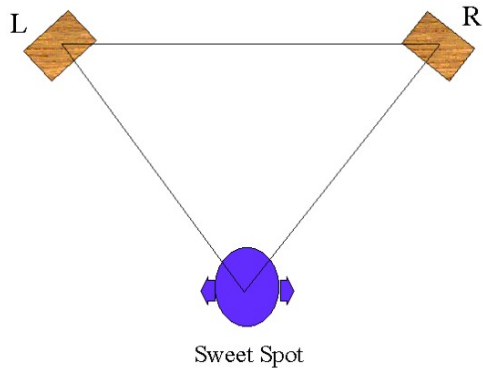

### 4. Turn surround sound functions off

When the surround sound effect is enabled, it will cause confusion with C3D sound, and make positional sound effect invalid.

## Appendix C - Solutions for Mini Disc

The MP3 player has been catching people's attention ever since its debut, as this pocket size player provides people with a more convenient access to the MP3 music enjoyment (in the past, it requires a PC to play MP3 music). Free download from the Internet, coupled with the easy-to-carry size, prompt many people to purchase a MP3 player with 64M bytes flash RAM, capable of playing music for sixty minutes.

Nevertheless, the MP3 player is not that perfect as imagined. First, if the users get tired of the stored music, they have to go back to their PCs for new download (it will cause inconvenience if they are out for travel and have no access to the Web). Even if a flash RAM can be added to the MP3 player for memory extension, still a problem exists. That is, who wants to spend nearly USD100 in order to save 5 songs/titles?

With the same budget (USD200), isn't there a better solution for the MP3 player? MD (Mini Disc) player is the answer.

The MD player has been available at the consumer electronics market for a period of time, and its popularity keeps growing in places like Japan, Hong Kong, and Europe. Each MD player is capable of storing high quality 74-minute music, and one blank MD costs less than USD2.00-4.00. More importantly, the most high-end 24-bit MD player costs around USD200. Since there is no expensive memory design, there is room for the MD player to drop its price. Compared with the MP3 player, the MD player surely got the upper hand.

The MD player is destined to be a hot seller; nevertheless, there is one big problem with the MD player application. That is, the MD player can not be directly connected to the PC. To remove this obstacle, our sound card offers an excellent solution: the optical fiber interface. The optical fiber interface within our sound card can provide easy access to people who

want to digitally record the MP3 music on their PC to the MD player. The optical fiber interface offers two applications: the output and the input.

### 1. The output:

- A. PC to MD player: this includes CD audio to MD player, WAV to MD player, and wave-table music to MD player.



<CASE-1> PC's CD-ROM player to MD

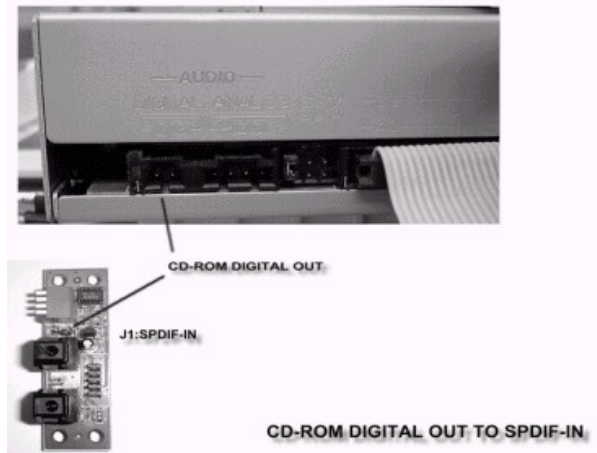

<CASE-2> Portable CD-ROM player to MD



B. PC to AC3 decoder or DAC.



## 2. The input:

- A. MD player to PC: the optical in can accept digital audio from the desktop MD player or high-end CD, and store it in 24-bit WAV format.

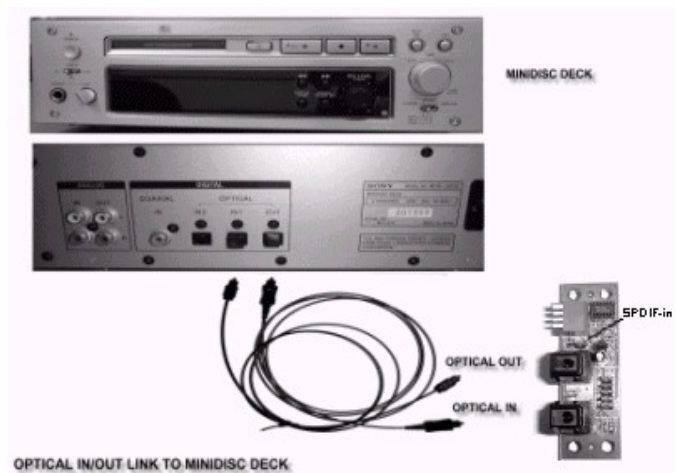

B. Hi-end CD to PC (with optical out)

**Using MP3/Wave Player to work with Mini Disc recording**

MP3/Wave Player is an easy and powerful tool for Mini Disc recording. Besides allowing you to create your favorite play list, it also provides a control interface of SPDIF IN/OUT of C-Media's sound card. The following 4 steps can help you create your album into Mini Disc easily.

- STEP 1.** Using optical fiber to connect the sound card and MD player. MD player will start to do the recording and turning on the SYNC mode. (See above 1. Output A. PC to MD player)
- STEP 2.** To execute MP3/Wave Player and modify the play list. You should select those files whose format can be recognized by MD Player. You can also change the sound effect if you like. (See also 5.1.4.)
- STEP 3.** In 'Setting' dialog, check 'Enable SPDIF-OUT', input the playback delay time, and select 5 Vp-p (Optical). Please note that in playback, if there is no lapse longer than three seconds between each track, the MD can not recognize the tracks and will record all of them into one. It is recommended that you set the lapse time to 3~5 seconds to meet all type of MD requirements.

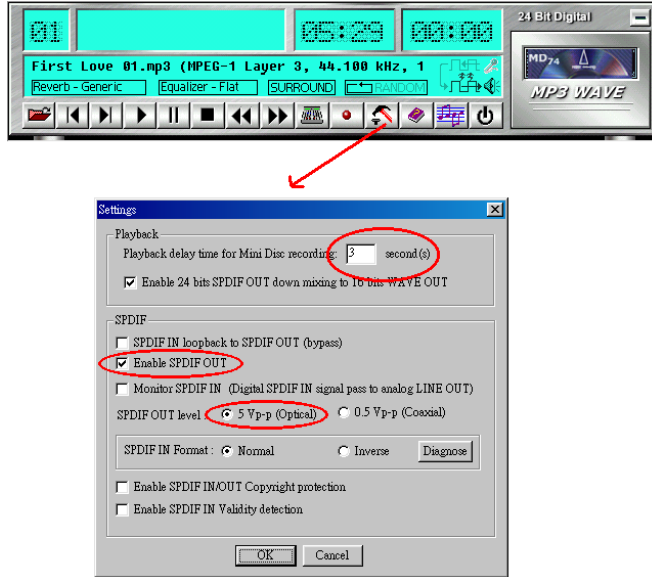

- STEP 4.** Start to play the songs. You will see that the MD Player starts to do the recording as well.

## Appendix D - Recording from SPDIF-IN

The optical module can connect to SPDIF-IN device, such as Portable CD-ROM player, CD-ROM driver, MD Player, etc. The Windows application and the MP3/Wave player can be used to do the recording of the signal from SPDIF-IN. The recording steps are as follows:

- STEP 1.** Use optical fiber or coaxial to connect the sound card and SPDIF-IN device. (See also Appendix C 2. Input)
- STEP 2.** Execute MP3/Wave Player. In 'Setting' dialog, select 5 Vp-p (Optical) or 0.5 Vp-p (Coaxial).

- STEP 3.** In 'Wave Recording' dialog, you should select the recording format and SPDIF-IN recording channel. Then input the file name. Before recording, please turn on your SPDIF-IN device and start to playback. Finally, press 'Record' to start the recording process.

