



M ▲ G E L L A N™

MG5000 V2.4

MG5050 V2.4

SP
S P E C T R A®

SP5500 V2.4

SP6000 V2.4

SP7000 V2.4

STAY D™

Programming Guide



We hope this product performs to your complete satisfaction. Should you have any questions or comments, please visit www.paradox.com and send us your comments.

P ▲ R ▲ D O X®
S E C U R I T Y S Y S T E M S

Table of Contents

Entering Programming Mode	2	Daylight Savings Programming	38
Codes and Panel Reset	2	Partition Programming	39
Installer Quick Menu	3	Communication Programming	40
System Overview	6	WinLoad Programming	45
Wireless Keypad Planning	6	Other Settings and Modes	45
Hardwired System Planning	7	Appendix 1: Ademco Contact ID Report Codes	46
Wireless System Planning	8	Appendix 2: Automatic Report Code List	48
Zone Programming	10	Appendix 3: Data Entry & Display	50
Keypad Programming	16	Trouble Display	51
Programmable Output Programming	17	Installer Function Keys	51
User Programming	24	Hardware Connections	52
Wireless Repeater Programming (MG-RPT1)	28	Connecting to WinLoad	55
Wireless Keypad Programming (MG32LRF)	31	Updating Firmware Using WinLoad	55
LCD Keypad Labels (MG32LCD)	32	Metal Box Installation	56
System Programming	36		

More detailed information can be found in the *Reference & Installation Manual*, which can be downloaded from our website at paradox.com.

 Warning or important information.	 Suggestion or reminder.	 Quick Menu (see page 3)
---	---	---

Entering Programming Mode

 **IMPORTANT:** *StayD Mode must be deactivated in order to enter programming mode. Press [OFF] + [CODE] + [OFF] to deactivate StayD.*

1. Press [ENTER]
2. Enter your [INSTALLER CODE] or [MAINTENANCE CODE]
3. Enter 3-digit [SECTION] you wish to program
4. Enter required [DATA]

Codes and Panel Reset

Installer Code (Default: 0000 / 000000)	The Installer code is used to enter programming mode, which allows you to program everything <u>except</u> user codes. To change the default code, go to section [397] on page 24 and refer to section [701] option [1] on page 36.
Maintenance Code (No Default)	The Maintenance code is used to enter programming mode, which allows you to program everything <u>except</u> for user codes and communication settings (sections [395], [397], [398], [815], [816], [817], [910], and [911]). To set the default code, go to section [398] on page 24 and refer to section [701] option [1] on page 36.
System Master Code (Default: 1234 / 123456)	The System Master code can use any arming method and can program user codes. To change the default code, go to section [399] on page 24 and refer to section [701] option [1] on page 36.
Panel Reset	Press and hold the RESET switch for five seconds. When the STATUS LED flashes, press the RESET switch within 2 seconds. However, this will not clear a bus module trouble (see section [955]). To reset the panel to default using section programming (see section [950]).



 **IMPORTANT:** *When using an SP Series panel, all wireless sections and options do not apply unless an MG-RTX3 is used in conjunction with the panel.*

IMPORTANT: *When using an SP6000 panel in conjunction with an MG-RTX3, all MG32LED and MG10LEDV/H keypads must be versions 2.0 or higher.*

IMPORTANT: *The MG32I Fixed LCD keypad module is only compatible with MG/SP panel version 2.30 and higher.*

Installer Quick Menu



Zones

Step	Action	Details
1	 + [INSTALLER CODE]	 = flash. Programmed zones are lit (button or LED depending on keypad). [MAINTENANCE CODE] may also be used.
2	[ZONE NUMBER]	MG32LRF/MG32LED/MG32I/MG32LCD = 2 digits: 01 to 32 MG10LEDV/H = 1 digit: 1 to 0(10)
3	[ENROLL OR ERASE ZONE]	Wireless zone = open/close cover or press learn/tamper switch. Hardwired zone = Press [ENTER]. To erase a programmed zone, press [SLEEP] for 3 seconds.
4	[ZONE TYPE]	Refer to <i>Zone Programming</i> on page 10 for the zone type (zone definition).
5	ASSIGN PARTITION [1] and/or [2] + [ENTER]	Assign the zone to one or both partitions and press [ENTER]. By default, all zones are assigned to partition 1. Goes to next available zone.
Notes	Partition 2 status LEDs, display the signal strength of the selected wireless zone (4 LEDs = best signal; 1 LED = weak signal; No LEDs = hardwired panel/keypad zone)	



Keypad Zone Number Assignment (Keypad Programming)

Step	Action	Details
1	[ENTER] + [INSTALLER CODE]	[ARM] + [STAY] = flash. [MAINTENANCE CODE] may also be used.
2	Press and hold  (3sec)	[ARM] + [STAY] = on.
3	[ZONE NUMBER] + [ENTER]*	MG32LED/MG32LCD/MG32I = 2 digits: 01 to 32 MG10LEDV/H = 1 digit: 1 to 0(10) * To erase a keypad zone number, press [CLEAR], then [ENTER].



Delays

Step	Action	Details
1	 + [INSTALLER CODE]	 = flash. [MAINTENANCE CODE] may also be used.
2		
3	[1] = Entry Delay 1 (sec.) [2] = Entry Delay 2 (sec.) [3] = Exit Delay (sec.) [4] = Bell Cut-Off (min.)	
4	[000] to [255]	Entry/Exit Delay = seconds / Bell Cut-Off = minutes / 000 = default value



Time and Date

Step	Action	Details
1	 + [INSTALLER CODE]	 = flash. [MAINTENANCE CODE] may also be used.
2	 + [5]	
4	[HH:MM]	Enter time. If HH = 13 or more, skip to step 6.
5	[TIME FORMAT]	Enter time format ([1] = 24hr; [2] = AM; [3] = PM).
6	[YYYY/MM/DD]	Enter date.



Walk Test Mode

Step	Action	Details
1	 + [INSTALLER CODE]	 = flash. [MAINTENANCE CODE] may also be used.
2		
3	[6]	Activates or deactivates Walk Test Mode.



Installer and Maintenance Codes

Step	Action	Details
1	 + [INSTALLER CODE]	 = flash.
2		
3	[7] = Installer Code [8] = Maintenance Code	
4	[CODE]*	Enter 4- or 6-digit code.* To erase a code, press the [SLEEP] key for 3 seconds.
5	[CONFIRM CODE]	Re-enter 4- or 6-digit code.



WinLoad

Step	Action	Details
1	 + [INSTALLER CODE]	 = flash.
2		
3	[9]	
4	[PHONE #] + [ENTER]*	Enter PC phone # (up to 32 digits) and press [ENTER].* To erase WinLoad phone #, panel ID, and PC password, press the [SLEEP] key for 3 seconds.
5	[PANEL ID]	Enter 4-digit Panel ID
6	[PC PASSWORD]	Enter 4-digit PC Password



Monitoring Phone

Step	Action	Details
1	 + [INSTALLER CODE]	 = flash.
2		
3	[1]	
4	[PHONE #] + [ENTER]*	Enter monitoring station phone # (up to 32 digits) and press [ENTER].* To erase monitoring phone #, reporting format, and account #s, press the [SLEEP] key for 3 seconds.
5	[PARTITION 1 ACCOUNT #]	
6	[1] = CID [2] = SIA	
7	[PARTITION 2 ACCOUNT #]	









Communicator

Step	Action	Details
1	 + [INSTALLER CODE]	 = flash. [MAINTENANCE CODE] may also be used, however, it cannot modify the backup phone number.
2		
3	[2] = Backup Phone # [3] = Personal Phone #1 [4] = Personal Phone #2 [5] = Personal Phone #3 [6] = Personal Phone #4 [7] = Personal Phone #5 [8] = Pager #	
4	[PHONE #] + [ENTER]*	Enter phone # (up to 32 digits) and press [ENTER]. Goes to next phone#, or go to step 5 if [8] = Pager # was selected. To erase a phone number pager message, press the [SLEEP] key for 3 seconds.
5	[MESSAGE] + [ENTER]	Step 5 for Pager # only. Enter pager message and press [ENTER].

Cancel Communication

Step	Action	Details
1	 + [INSTALLER CODE]	 = flash. [MAINTENANCE CODE] may also be used.
2		
3	[9]	Cancels all communication with WinLoad.

PGMs

Step	Action	Details									
1	 + [INSTALLER CODE]	 = flash. Programmed zones are lit (button or LED depending on keypad). [MAINTENANCE CODE] may also be used.									
2											
3	[PGM NUMBER]	MG32LRF/MG32LED/MG32LCD/MG32I = 2 digits: 01 to 16 MG10LEDV/H = 1 digit: 1 to 0(10)									
4	[ENROLL OR ERASE PGM]*	Wireless PGM = Open/close cover. Hardwired PGM = press [ENTER]. To erase a PGM, press the [SLEEP] key for 3 seconds.									
5	[PGM TYPE]	<table border="0"> <tr> <td>1 = Follow Button  or ●</td> <td>5 = Follow Bell</td> </tr> <tr> <td>2 = Follow Button  or ⋮</td> <td>6 = Follow Arm</td> </tr> <tr> <td>3 = Follow Zone</td> <td>7 = Follow Stay arm</td> </tr> <tr> <td>4 = Follow Alarm</td> <td>8 = Follow Sleep arm</td> </tr> </table>	1 = Follow Button  or ●	5 = Follow Bell	2 = Follow Button  or ⋮	6 = Follow Arm	3 = Follow Zone	7 = Follow Stay arm	4 = Follow Alarm	8 = Follow Sleep arm	
1 = Follow Button  or ●	5 = Follow Bell										
2 = Follow Button  or ⋮	6 = Follow Arm										
3 = Follow Zone	7 = Follow Stay arm										
4 = Follow Alarm	8 = Follow Sleep arm										
6	If PGM type is 1, 2, 3, or 4 [ACTIVATION DELAY]	<table border="0"> <tr> <td>1 = Follow</td> <td>4 = 15 seconds</td> <td>7 = 5 minutes</td> </tr> <tr> <td>2 = 1 second</td> <td>5 = 30 seconds</td> <td>8 = 15 minutes</td> </tr> <tr> <td>3 = 5 seconds</td> <td>6 = 1 minute</td> <td>9 = 30 minutes</td> </tr> </table>	1 = Follow	4 = 15 seconds	7 = 5 minutes	2 = 1 second	5 = 30 seconds	8 = 15 minutes	3 = 5 seconds	6 = 1 minute	9 = 30 minutes
1 = Follow	4 = 15 seconds	7 = 5 minutes									
2 = 1 second	5 = 30 seconds	8 = 15 minutes									
3 = 5 seconds	6 = 1 minute	9 = 30 minutes									
	If PGM type is 5 Goes to next available PGM.										
	If PGM type is 6, 7, or 8 [1] and/or [2] + [ENTER]	If system is partitioned, select partition(s) and press [ENTER]. Goes to next available PGM.									
7	If PGM type is 1, or 2 [2-DIGIT REMOTE CONTROL #]	01 to 32; 00 = all remote controls. Goes to next available PGM.									
	If PGM type is 3 [2-DIGIT ZONE #]	01 to 32; 00 = all zones. Goes to next available PGM.									
	If PGM type is 4 [1] and/or [2] + [ENTER]	If system is partitioned, select partition(s) and press [ENTER]. Goes to next available PGM.									

System Overview

Module	Description	Maximum number per system	Current Consumption
MG32LRF	32-Zone Wireless LED Keypad Module	8	Min. = 44mA / Max. = 72mA
MG10LEDV/H, MG32LED, MG32LCD, MG32I	10 and 32-Zone Hardwired Keypad Module	15 total including APR-ZX8	MG10LED: Min. = 44mA / Max. = 72mA MG32LED: Min. = 49mA / Max. = 148mA MG32LCD: Min. = 43mA / Max. = 86mA MG32I: Min. = 30mA / Max. = 70mA
APR-ZX8	8-Zone Expansion Module	3	Min. = 29mA / Max. = 31mA
MG-RPT1	Magellan Wireless Repeater Module	2	Average = 57mA
VDMP3	Plug-In Voice Dialer	1	Min. = 28mA / Max. = 28mA
IP100	Internet Module	1	Min. = 90mA / Max. = 120mA
MG-RTX3	Wireless Expansion Module (Spectra SP only)	1	Min. = 61mA / Max. = 143mA

Wireless Keypad Planning

Serial # Sticker	Description	Path Zone (Entry Point)	Path Zone	Path Zone	Path Zone
MG32LRF 1					
MG32LRF 2					
MG32LRF 3					
MG32LRF 4					
MG32LRF 5					
MG32LRF 6					
MG32LRF 7					
MG32LRF 8					



When deleting a wireless keypad (MG32LRF) from the system, the corresponding StayD path zones will also be deleted.

Hardwired System Planning

IMPORTANT: Maximum of 3 APR-ZX8 modules.

Serial # Sticker	Description	Path Zone (Entry Point)	Path Zone	Path Zone	Path Zone
Keypad 1/ APR-ZX8					
Keypad 2/ APR-ZX8					
Keypad 3/ APR-ZX8					
Keypad 4/ APR-ZX8					
Keypad 5/ APR-ZX8					
Keypad 6/ APR-ZX8					
Keypad 7/ APR-ZX8					
Keypad 8/ APR-ZX8					
Keypad 9/ APR-ZX8					
Keypad 10/ APR-ZX8					
Keypad 11/ APR-ZX8					
Keypad 12/ APR-ZX8					
Keypad 13/ APR-ZX8					
Keypad 14/ APR-ZX8					
Keypad 15/ APR-ZX8					

Wireless System Planning

Serial # Sticker	Description
PGM 1	
PGM 2	
PGM 3	
PGM 4	
PGM 5	
PGM 6	
PGM 7	
PGM 8	

Serial # Sticker	Description
Repeater 1	

Serial # Sticker	Description
PGM 9	
PGM 10	
PGM 11	
PGM 12	
PGM 13	
PGM 14	
PGM 15	
PGM 16	

Serial # Sticker	Description
Repeater 2	

Serial # Sticker		Zone#	Zone Description	Armed when...			Serial # Sticker		Zone#	Zone Description	Armed when...		
Wireless/APR-ZX8				Stay	Sleep	Full	Wireless/APR-ZX8				Stay	Sleep	Full
Zone				<input type="checkbox"/>	<input type="checkbox"/>	<input type="checkbox"/>	Zone				<input type="checkbox"/>	<input type="checkbox"/>	<input type="checkbox"/>
Zone				<input type="checkbox"/>	<input type="checkbox"/>	<input type="checkbox"/>	Zone				<input type="checkbox"/>	<input type="checkbox"/>	<input type="checkbox"/>
Zone				<input type="checkbox"/>	<input type="checkbox"/>	<input type="checkbox"/>	Zone				<input type="checkbox"/>	<input type="checkbox"/>	<input type="checkbox"/>
Zone				<input type="checkbox"/>	<input type="checkbox"/>	<input type="checkbox"/>	Zone				<input type="checkbox"/>	<input type="checkbox"/>	<input type="checkbox"/>
Zone				<input type="checkbox"/>	<input type="checkbox"/>	<input type="checkbox"/>	Zone				<input type="checkbox"/>	<input type="checkbox"/>	<input type="checkbox"/>
Zone				<input type="checkbox"/>	<input type="checkbox"/>	<input type="checkbox"/>	Zone				<input type="checkbox"/>	<input type="checkbox"/>	<input type="checkbox"/>
Zone				<input type="checkbox"/>	<input type="checkbox"/>	<input type="checkbox"/>	Zone				<input type="checkbox"/>	<input type="checkbox"/>	<input type="checkbox"/>
Zone				<input type="checkbox"/>	<input type="checkbox"/>	<input type="checkbox"/>	Zone				<input type="checkbox"/>	<input type="checkbox"/>	<input type="checkbox"/>
Zone				<input type="checkbox"/>	<input type="checkbox"/>	<input type="checkbox"/>	Zone				<input type="checkbox"/>	<input type="checkbox"/>	<input type="checkbox"/>
Zone				<input type="checkbox"/>	<input type="checkbox"/>	<input type="checkbox"/>	Zone				<input type="checkbox"/>	<input type="checkbox"/>	<input type="checkbox"/>
Zone				<input type="checkbox"/>	<input type="checkbox"/>	<input type="checkbox"/>	Zone				<input type="checkbox"/>	<input type="checkbox"/>	<input type="checkbox"/>
Zone				<input type="checkbox"/>	<input type="checkbox"/>	<input type="checkbox"/>	Zone				<input type="checkbox"/>	<input type="checkbox"/>	<input type="checkbox"/>
Zone				<input type="checkbox"/>	<input type="checkbox"/>	<input type="checkbox"/>	Zone				<input type="checkbox"/>	<input type="checkbox"/>	<input type="checkbox"/>
Zone				<input type="checkbox"/>	<input type="checkbox"/>	<input type="checkbox"/>	Zone				<input type="checkbox"/>	<input type="checkbox"/>	<input type="checkbox"/>
Zone				<input type="checkbox"/>	<input type="checkbox"/>	<input type="checkbox"/>	Zone				<input type="checkbox"/>	<input type="checkbox"/>	<input type="checkbox"/>
Zone				<input type="checkbox"/>	<input type="checkbox"/>	<input type="checkbox"/>	Zone				<input type="checkbox"/>	<input type="checkbox"/>	<input type="checkbox"/>
Zone				<input type="checkbox"/>	<input type="checkbox"/>	<input type="checkbox"/>	Zone				<input type="checkbox"/>	<input type="checkbox"/>	<input type="checkbox"/>
Zone				<input type="checkbox"/>	<input type="checkbox"/>	<input type="checkbox"/>	Zone				<input type="checkbox"/>	<input type="checkbox"/>	<input type="checkbox"/>
Zone				<input type="checkbox"/>	<input type="checkbox"/>	<input type="checkbox"/>	Zone				<input type="checkbox"/>	<input type="checkbox"/>	<input type="checkbox"/>
Zone				<input type="checkbox"/>	<input type="checkbox"/>	<input type="checkbox"/>	Zone				<input type="checkbox"/>	<input type="checkbox"/>	<input type="checkbox"/>

Zone Programming



For keypad zone programming, see page 16.

Zone Definitions	Stay Arm	Sleep Arm	Fully Arm	Zone Definitions
00 = Zone Disabled (default)	-	-	-	11 = Instant Fire†
01 = Entry Delay 1	Entry Delay 1	Entry Delay 1	Entry Delay 1	12 = Delayed Fire†
02 = Entry Delay 2	Entry Delay 2	Entry Delay 2	Entry Delay 2	13 = Instant Fire Silent†
03 = Entry Delay 1 (Full Arm)	Not Armed	Not Armed	Entry Delay 1	14 = Delayed Fire Silent†
04 = Entry Delay2 (Full Arm)	Not Armed	Not Armed	Entry Delay 2	15 = 24Hr. Buzzer
05 = Follow	Follow*	Follow*	Follow	16 = 24Hr. Burglary
06 = Follow (Sleep/Full Arm)	Not Armed	Follow*	Follow	17 = 24Hr. Hold-up
07 = Follow (Full Arm)	Not Armed	Not Armed	Follow	18 = 24Hr. Gas
08 = Instant	Instant*	Instant*	Instant	19 = 24Hr. Heat
09 = Instant (Sleep/Full Arm)	Not Armed	Instant*	Instant	20 = 24Hr. Water
10 = Instant (Full Arm)	Not Armed	Not Armed	Instant	21 = 24Hr. Freeze
				22 = 24hr. Panic
				23 = Instant No Pre-Alarm
				24 = Follow No Pre-Alarm
				25 = Keyswitch Maintain**
				26 = Keyswitch Momentary**

* Flex-Instant = Zone will follow the delay at section [720], (default is 15 seconds / 0 = instant zone)
 ** On-board hardwire control panel zones and APR-ZX8 expansion zones only
 † APR-ZX8 inputs do not support fire zones.
 For 2-wire smoke installations (not supported by SP5500), these definitions apply to Zone 1 Input only. Section [706], option [3] must be enabled.
 For 4-wire smoke installations, use any panel on-board zone input.

Partition Assignment
 [1]- Partition 1
 [2]- Partition 2
 [3]- Both partitions

Zone Options
 [1] = Auto-zone Shutdown
 [2] = Bypassable Zone
 [3] = RF Zone Supervision
 [4] [5]
OFF OFF Audible Alarm
 OFF ON Pulsed Alarm
 ON OFF Silent Alarm
 ON ON Report Only
 [6] = Intellizone
 [7] = Delay alarm transmission
 [8] = Force Zone

Keyswitch Options (25-26)
 [1]- N/A
 [2]- N/A
 [3]- N/A
 [4] **OFF = Disarm**
 ON = Disarm only if Stay/
 Sleep armed
 [5] = Arm only
 [6] = Stay arming*
 [7] = Sleep arming*
 [8] = N/A
 * Select only one. If all are off, keyswitch will regular arm.

Zone*	Section	Zone Definition	Partition	Zone Options	Section	Wireless SN or press tamper/ learn To delete, enter 000000
Zone 1: _____	[001]	___/___	___	1 2 3 4 5 6 7 8	[061]	___/___/___/___/___
Zone 2: _____	[002]	___/___	___	1 2 3 4 5 6 7 8	[062]	___/___/___/___/___
Zone 3: _____	[003]	___/___	___	1 2 3 4 5 6 7 8	[063]	___/___/___/___/___
Zone 4: _____	[004]	___/___	___	1 2 3 4 5 6 7 8	[064]	___/___/___/___/___
Zone 5: _____	[005]	___/___	___	1 2 3 4 5 6 7 8	[065]	___/___/___/___/___
Zone 6: _____	[006]	___/___	___	1 2 3 4 5 6 7 8	[066]	___/___/___/___/___
Zone 7: _____	[007]	___/___	___	1 2 3 4 5 6 7 8	[067]	___/___/___/___/___
Zone 8: _____	[008]	___/___	___	1 2 3 4 5 6 7 8	[068]	___/___/___/___/___
Zone 9: _____	[009]	___/___	___	1 2 3 4 5 6 7 8	[069]	___/___/___/___/___
Zone 10: _____	[010]	___/___	___	1 2 3 4 5 6 7 8	[070]	___/___/___/___/___
Zone 11: _____	[011]	___/___	___	1 2 3 4 5 6 7 8	[071]	___/___/___/___/___
Zone 12: _____	[012]	___/___	___	1 2 3 4 5 6 7 8	[072]	___/___/___/___/___
Zone 13: _____	[013]	___/___	___	1 2 3 4 5 6 7 8	[073]	___/___/___/___/___
Zone 14: _____	[014]	___/___	___	1 2 3 4 5 6 7 8	[074]	___/___/___/___/___
Zone 15: _____	[015]	___/___	___	1 2 3 4 5 6 7 8	[075]	___/___/___/___/___
Zone 16: _____	[016]	___/___	___	1 2 3 4 5 6 7 8	[076]	___/___/___/___/___
Zone 17: _____	[017]	___/___	___	1 2 3 4 5 6 7 8	[077]	___/___/___/___/___
Zone 18: _____	[018]	___/___	___	1 2 3 4 5 6 7 8	[078]	___/___/___/___/___
Zone 19: _____	[019]	___/___	___	1 2 3 4 5 6 7 8	[079]	___/___/___/___/___
Zone 20: _____	[020]	___/___	___	1 2 3 4 5 6 7 8	[080]	___/___/___/___/___
Zone 21: _____	[021]	___/___	___	1 2 3 4 5 6 7 8	[081]	___/___/___/___/___
Zone 22: _____	[022]	___/___	___	1 2 3 4 5 6 7 8	[082]	___/___/___/___/___
Zone 23: _____	[023]	___/___	___	1 2 3 4 5 6 7 8	[083]	___/___/___/___/___
Zone 24: _____	[024]	___/___	___	1 2 3 4 5 6 7 8	[084]	___/___/___/___/___
Zone 25: _____	[025]	___/___	___	1 2 3 4 5 6 7 8	[085]	___/___/___/___/___
Zone 26: _____	[026]	___/___	___	1 2 3 4 5 6 7 8	[086]	___/___/___/___/___
Zone 27: _____	[027]	___/___	___	1 2 3 4 5 6 7 8	[087]	___/___/___/___/___
Zone 28: _____	[028]	___/___	___	1 2 3 4 5 6 7 8	[088]	___/___/___/___/___
Zone 29: _____	[029]	___/___	___	1 2 3 4 5 6 7 8	[089]	___/___/___/___/___
Zone 30: _____	[030]	___/___	___	1 2 3 4 5 6 7 8	[090]	___/___/___/___/___
Zone 31: _____	[031]	___/___	___	1 2 3 4 5 6 7 8	[091]	___/___/___/___/___
Zone 32: _____	[032]	___/___	___	1 2 3 4 5 6 7 8	[092]	___/___/___/___/___

* See Zone Recognition tables on page 12 and page 13.



Refer to the **Installer Quick Menu** on page 3.

Zone Recognition (MG Series)

	MG5000 No ATZ	MG5000 ATZ	MG5050 No ATZ	MG5050 ATZ
Zone 1:	Panel Input 1	Panel Input 1A	Panel Input 1	Panel Input 1A
Zone 2:	Panel Input 2	Panel Input 2A	Panel Input 2	Panel Input 2A
Zone 3:	ZX8 A Input 1	Panel Input 1B	Panel Input 3	Panel Input 3A
Zone 4:	Input 2	Panel Input 2B	Panel Input 4	Panel Input 4A
Zone 5:	Input 3	ZX8 A Input 1	Panel Input 5	Panel Input 5A
Zone 6:	Input 4	Input 2	ZX8 A Input 1	Panel Input 1B
Zone 7:	Input 5	Input 3	Input 2	Panel Input 2B
Zone 8:	Input 6	Input 4	Input 3	Panel Input 3B
Zone 9:	Input 7	Input 5	Input 4	Panel Input 4B
Zone 10:	Input 8	Input 6	Input 5	Panel Input 5B
Zone 11:	ZX8 B Input 1	Input 7	Input 6	ZX8 A Input 1
Zone 12:	Input 2	Input 8	Input 7	Input 2
Zone 13:	Input 3	ZX8 B Input 1	Input 8	Input 3
Zone 14:	Input 4	Input 2	ZX8 B Input 1	Input 4
Zone 15:	Input 5	Input 3	Input 2	Input 5
Zone 16:	Input 6	Input 4	Input 3	Input 6
Zone 17:	Input 7	Input 5	Input 4	Input 7
Zone 18:	Input 8	Input 6	Input 5	Input 8
Zone 19:	ZX8 C Input 1	Input 7	Input 6	ZX8 B Input 1
Zone 20:	Input 2	Input 8	Input 7	Input 2
Zone 21:	Input 3	ZX8 C Input 1	Input 8	Input 3
Zone 22:	Input 4	Input 2	ZX8 C Input 1	Input 4
Zone 23:	Input 5	Input 3	Input 2	Input 5
Zone 24:	Input 6	Input 4	Input 3	Input 6
Zone 25:	Input 7	Input 5	Input 4	Input 7
Zone 26:	Input 8	Input 6	Input 5	Input 8
Zone 27:	N/A	Input 7	Input 6	ZX8 C Input 1
Zone 28:	N/A	Input 8	Input 7	Input 2
Zone 29:	N/A	N/A	Input 8	Input 3
Zone 30:	N/A	N/A	N/A	Input 4
Zone 31:	N/A	N/A	N/A	Input 5
Zone 32:	N/A	N/A	N/A	Input 6



Jumper settings for the APR-ZX8: **A** = Panel +1, **B** = Panel + 9, **C** = Panel + 17.



If a zone is already programmed and you assign a device to the same zone, a wireless zone will overwrite a keypad/hardwire zone, and a keypad zone will overwrite a hardwire zone.

Zone Recognition (SP Series)

	SP5500 No ATZ	SP5500 ATZ	SP6000 No ATZ	SP6000 ATZ	SP7000 No ATZ	SP7000 ATZ
Zone 1:	Panel Input 1	Panel Input 1A	Panel Input 1	Panel Input 1A	Panel Input 1	Panel Input 1A
Zone 2:	Panel Input 2	Panel Input 2A	Panel Input 2	Panel Input 2A	Panel Input 2	Panel Input 2A
Zone 3:	Panel Input 3	Panel Input 3A	Panel Input 3	Panel Input 3A	Panel Input 3	Panel Input 3A
Zone 4:	Panel Input 4	Panel Input 4A	Panel Input 4	Panel Input 4A	Panel Input 4	Panel Input 4A
Zone 5:	Panel Input 5	Panel Input 5A	Panel Input 5	Panel Input 5A	Panel Input 5	Panel Input 5A
Zone 6:	ZX8 Panel Input 1	Panel Input 1B	Panel Input 6	Panel Input 6A	Panel Input 6	Panel Input 6A
Zone 7:	Input 2	Panel Input 2B	Panel Input 7	Panel Input 7A	Panel Input 7	Panel Input 7A
Zone 8:	Input 3	Panel Input 3B	Panel Input 8	Panel Input 8A	Panel Input 8	Panel Input 8A
Zone 9:	Input 4	Panel Input 4B	ZX8 A Input 1	Panel Input 1B	Panel Input 9	Panel Input 9A
Zone 10:	Input 5	Panel Input 5B	Input 2	Panel Input 2B	Panel Input 10	Panel Input 10A
Zone 11:	Input 6	ZX8 A Input 1	Input 3	Panel Input 3B	Panel Input 11	Panel Input 11A
Zone 12:	Input 7	Input 2	Input 4	Panel Input 4B	Panel Input 12	Panel Input 12A
Zone 13:	Input 8	Input 3	Input 5	Panel Input 5B	Panel Input 13	Panel Input 13A
Zone 14:	ZX8 B Input 1	Input 4	Input 6	Panel Input 6B	Panel Input 14	Panel Input 14A
Zone 15:	Input 2	Input 5	Input 7	Panel Input 7B	Panel Input 15	Panel Input 15A
Zone 16:	Input 3	Input 6	Input 8	Panel Input 8B	Panel Input 16	Panel Input 16A
Zone 17:	Input 4	Input 7	ZX8 B Input 1	ZX8 A Input 1	ZX8 A Input 1	Panel Input 1B
Zone 18:	Input 5	Input 8	Input 2	Input 2	Input 2	Panel Input 2B
Zone 19:	Input 6	ZX8 B Input 1	Input 3	Input 3	Input 3	Panel Input 3B
Zone 20:	Input 7	Input 2	Input 4	Input 4	Input 4	Panel Input 4B
Zone 21:	Input 8	Input 3	Input 5	Input 5	Input 5	Panel Input 5B
Zone 22:	ZX8 C Input 1	Input 4	Input 6	Input 6	Input 6	Panel Input 6B
Zone 23:	Input 2	Input 5	Input 7	Input 7	Input 7	Panel Input 7B
Zone 24:	Input 3	Input 6	Input 8	Input 8	Input 8	Panel Input 8B
Zone 25:	Input 4	Input 7	ZX8 C Input 1	ZX8 B Input 1	ZX8 B Input 1	Panel Input 9B
Zone 26:	Input 5	Input 8	Input 2	Input 2	Input 2	Panel Input 10B
Zone 27:	Input 6	ZX8 C Input 1	Input 3	Input 3	Input 3	Panel Input 11B
Zone 28:	Input 7	Input 2	Input 4	Input 4	Input 4	Panel Input 12B
Zone 29:	Input 8	Input 3	Input 5	Input 5	Input 5	Panel Input 13B
Zone 30:	N/A	Input 4	Input 6	Input 6	Input 6	Panel Input 14B
Zone 31:	N/A	Input 5	Input 7	Input 7	Input 7	Panel Input 15B
Zone 32:	N/A	Input 6	Input 8	Input 8	Input 8	Panel Input 16B



Jumper settings for the APR-ZX8: **A** = Panel +1, **B** = Panel + 9, **C** = Panel + 17.



If a zone is already programmed and you assign a device to the same zone, a wireless zone will overwrite a keypad/hardwire zone, and a keypad zone will overwrite a hardwire zone.

Zone Timers (MG Series)

Section	MG5000	MG5050	Data	Description (Default 060)
[041] Zone 1	(Z1):	(Z1):	___/___/___ (000 to 255) x 10ms	Hardwire Zone 1 Speed
[042] Zone 2	(Z2):	(Z2):	___/___/___ (000 to 255) x 10ms	Hardwire Zone 2 Speed
[043] Zone 3	(Z1 with ATZ):	(Z3):	___/___/___ (000 to 255) x 10ms	Hardwire Zone 3 Speed
[044] Zone 4	(Z2 with ATZ):	(Z4):	___/___/___ (000 to 255) x 10ms	Hardwire Zone 4 Speed
[045] Zone 5		(Z5):	___/___/___ (000 to 255) x 10ms	Hardwire Zone 5 Speed
[046] Zone 6		(Z1 with ATZ):	___/___/___ (000 to 255) x 10ms	Hardwire Zone 6 Speed
[047] Zone 7		(Z2 with ATZ):	___/___/___ (000 to 255) x 10ms	Hardwire Zone 7 Speed
[048] Zone 8		(Z3 with ATZ):	___/___/___ (000 to 255) x 10ms	Hardwire Zone 8 Speed
[049] Zone 9		(Z4 with ATZ):	___/___/___ (000 to 255) x 10ms	Hardwire Zone 9 Speed
[050] Zone 10		(Z5 with ATZ):	___/___/___ (000 to 255) x 10ms	Hardwire Zone 10 Speed
[051] Zone 11			___/___/___ (000 to 255) x 10ms	Hardwire Zone 11 Speed
[052] Zone 12			___/___/___ (000 to 255) x 10ms	Hardwire Zone 12 Speed
[053] Zone 13			___/___/___ (000 to 255) x 10ms	Hardwire Zone 13 Speed
[054] Zone 14			___/___/___ (000 to 255) x 10ms	Hardwire Zone 14 Speed
[055] Zone 15			___/___/___ (000 to 255) x 10ms	Hardwire Zone 15 Speed
[056] Zone 16			___/___/___ (000 to 255) x 10ms	Hardwire Zone 16 Speed

Zone Timers (SP Series)

Section	SP5500	SP6000	SP7000*	Data	Description (Default 060)
[041] Zone 1	(Z1):	(Z1):	(Z1):	___/___/___ (000 to 255) x 10ms	Hardwire Zone 1 Speed
[042] Zone 2	(Z2):	(Z2):	(Z2):	___/___/___ (000 to 255) x 10ms	Hardwire Zone 2 Speed
[043] Zone 3	(Z3):	(Z3):	(Z3):	___/___/___ (000 to 255) x 10ms	Hardwire Zone 3 Speed
[044] Zone 4	(Z4):	(Z4):	(Z4):	___/___/___ (000 to 255) x 10ms	Hardwire Zone 4 Speed
[045] Zone 5	(Z5):	(Z5):	(Z5):	___/___/___ (000 to 255) x 10ms	Hardwire Zone 5 Speed
[046] Zone 6	(Z1 with ATZ):	(Z6):	(Z6):	___/___/___ (000 to 255) x 10ms	Hardwire Zone 6 Speed
[047] Zone 7	(Z2 with ATZ):	(Z7):	(Z7):	___/___/___ (000 to 255) x 10ms	Hardwire Zone 7 Speed
[048] Zone 8	(Z3 with ATZ):	(Z8):	(Z8):	___/___/___ (000 to 255) x 10ms	Hardwire Zone 8 Speed
[049] Zone 9	(Z4 with ATZ):	(Z1 with ATZ):	(Z9):	___/___/___ (000 to 255) x 10ms	Hardwire Zone 9 Speed
[050] Zone 10	(Z5 with ATZ):	(Z2 with ATZ):	(Z10):	___/___/___ (000 to 255) x 10ms	Hardwire Zone 10 Speed
[051] Zone 11		(Z3 with ATZ):	(Z11):	___/___/___ (000 to 255) x 10ms	Hardwire Zone 11 Speed
[052] Zone 12		(Z4 with ATZ):	(Z12):	___/___/___ (000 to 255) x 10ms	Hardwire Zone 12 Speed
[053] Zone 13		(Z5 with ATZ):	(Z13):	___/___/___ (000 to 255) x 10ms	Hardwire Zone 13 Speed
[054] Zone 14		(Z6 with ATZ):	(Z14):	___/___/___ (000 to 255) x 10ms	Hardwire Zone 14 Speed
[055] Zone 15		(Z7 with ATZ):	(Z15):	___/___/___ (000 to 255) x 10ms	Hardwire Zone 15 Speed
[056] Zone 16		(Z8 with ATZ):	(Z16):	___/___/___ (000 to 255) x 10ms	Hardwire Zone 16 Speed

* SP7000: For zones 17-32 (ATZ), the zone timer is set at 60 seconds.

Wireless Transmitter Signal Strength

Section	Section	Section	Section
[101] Zone 1	[109] Zone 9	[117] Zone 17	[125] Zone 25
[102] Zone 2	[110] Zone 10	[118] Zone 18	[126] Zone 26
[103] Zone 3	[111] Zone 11	[119] Zone 19	[127] Zone 27
[104] Zone 4	[112] Zone 12	[120] Zone 20	[128] Zone 28
[105] Zone 5	[113] Zone 13	[121] Zone 21	[129] Zone 29
[106] Zone 6	[114] Zone 14	[122] Zone 22	[130] Zone 30
[107] Zone 7	[115] Zone 15	[123] Zone 23	[131] Zone 31
[108] Zone 8	[116] Zone 16	[124] Zone 24	[132] Zone 32

Signal Strength Indicator	8 to 10 / 3 beeps = Best signal	5 to 7 / 2 beeps = Average signal	1 to 4 / 1 beep = Weak signal (Relocate)
---------------------------	---------------------------------	-----------------------------------	--



To view the wireless transmitter signal strength, press the wireless transmitter's anti-tamper switch while in the respective section.

Zone Reporting Codes (Default = FF)

Section	Alarm	Alarm Restore	Tamper	Tamper Restore
[141] Zone 1:	___/___	___/___	___/___	___/___
[142] Zone 2:	___/___	___/___	___/___	___/___
[143] Zone 3:	___/___	___/___	___/___	___/___
[144] Zone 4:	___/___	___/___	___/___	___/___
[145] Zone 5:	___/___	___/___	___/___	___/___
[146] Zone 6:	___/___	___/___	___/___	___/___
[147] Zone 7:	___/___	___/___	___/___	___/___
[148] Zone 8:	___/___	___/___	___/___	___/___
[149] Zone 9:	___/___	___/___	___/___	___/___
[150] Zone 10:	___/___	___/___	___/___	___/___
[151] Zone 11:	___/___	___/___	___/___	___/___
[152] Zone 12:	___/___	___/___	___/___	___/___
[153] Zone 13:	___/___	___/___	___/___	___/___
[154] Zone 14:	___/___	___/___	___/___	___/___
[155] Zone 15:	___/___	___/___	___/___	___/___
[156] Zone 16:	___/___	___/___	___/___	___/___
[157] Zone 17:	___/___	___/___	___/___	___/___
[158] Zone 18:	___/___	___/___	___/___	___/___
[159] Zone 19:	___/___	___/___	___/___	___/___
[160] Zone 20:	___/___	___/___	___/___	___/___
[161] Zone 21:	___/___	___/___	___/___	___/___
[162] Zone 22:	___/___	___/___	___/___	___/___
[163] Zone 23:	___/___	___/___	___/___	___/___
[164] Zone 24:	___/___	___/___	___/___	___/___
[165] Zone 25:	___/___	___/___	___/___	___/___
[166] Zone 26:	___/___	___/___	___/___	___/___
[167] Zone 27:	___/___	___/___	___/___	___/___
[168] Zone 28:	___/___	___/___	___/___	___/___
[169] Zone 29:	___/___	___/___	___/___	___/___
[170] Zone 30:	___/___	___/___	___/___	___/___
[171] Zone 31:	___/___	___/___	___/___	___/___
[172] Zone 32:	___/___	___/___	___/___	___/___



Refer to *Decimal and Hexadecimal Values* on page 50.

Keypad Programming

Keypad Zone Number Assignment

Step	Action	Details
1	[ENTER] + [INSTALLER CODE] (default: 0000 / 000000)	[ARM] + [STAY] = flash. [MAINTENANCE CODE] may also be used.
2	Press and hold  (3sec)	[ARM] + [STAY] = on
3	[ZONE NUMBER] + [ENTER]*	MG32LED/MG32LCD= 2 digits: 01 to 32 MG10LEDV/H = 1 digit: 1 to 0(10) * To erase a keypad zone number, press [CLEAR], then [ENTER].

Entry Point Zone Assignment (StayD)

Step	Action	Details
1	[ENTER] + [INSTALLER CODE] (default: 0000 / 000000)	[ARM] + [STAY] = flash.
2	Press and hold [OFF] (3sec)	[ARM] + [STAY] = on
3	[ZONE NUMBER]*	MG32LED/MG32LCD = 2 digits: 01 to 32 MG10LEDV/H = 1 digit: 1 to 0(10) * The first zone you program will be the designated entry point and will flash. Up to three more path zones can be added; these zones will light up and stay lit.
4	[ENTER]	Press [ENTER] to save and exit

Programmable Output Programming

Programmable Output Activation/Deactivation Events

	Section	Event Group #	Sub-Group #	Partition # (99 for both partitions)	Default
[220]	PGM 1: Activation Event	(___/___)	(___/___)	(___/___)	08/99/99*
[221]	Deactivation Event	(___/___)	(___/___)	(___/___)	00/00/00
[222]	PGM 2: Activation Event	(___/___)	(___/___)	(___/___)	09/99/99†
[223]	Deactivation Event	(___/___)	(___/___)	(___/___)	00/00/00
[224]	PGM 3: Activation Event	(___/___)	(___/___)	(___/___)	00/00/00
[225]	Deactivation Event	(___/___)	(___/___)	(___/___)	00/00/00
[226]	PGM 4: Activation Event	(___/___)	(___/___)	(___/___)	00/00/00
[227]	Deactivation Event	(___/___)	(___/___)	(___/___)	00/00/00
[228]	PGM 5: Activation Event	(___/___)	(___/___)	(___/___)	00/00/00
[229]	Deactivation Event	(___/___)	(___/___)	(___/___)	00/00/00
[230]	PGM 6: Activation Event	(___/___)	(___/___)	(___/___)	00/00/00
[231]	Deactivation Event	(___/___)	(___/___)	(___/___)	00/00/00
[232]	PGM 7: Activation Event	(___/___)	(___/___)	(___/___)	00/00/00
[233]	Deactivation Event	(___/___)	(___/___)	(___/___)	00/00/00
[234]	PGM 8: Activation Event	(___/___)	(___/___)	(___/___)	00/00/00
[235]	Deactivation Event	(___/___)	(___/___)	(___/___)	00/00/00
[236]	PGM 9: Activation Event	(___/___)	(___/___)	(___/___)	00/00/00
[237]	Deactivation Event	(___/___)	(___/___)	(___/___)	00/00/00
[238]	PGM 10: Activation Event	(___/___)	(___/___)	(___/___)	00/00/00
[239]	Deactivation Event	(___/___)	(___/___)	(___/___)	00/00/00
[240]	PGM 11: Activation Event	(___/___)	(___/___)	(___/___)	00/00/00
[241]	Deactivation Event	(___/___)	(___/___)	(___/___)	00/00/00
[242]	PGM 12: Activation Event	(___/___)	(___/___)	(___/___)	00/00/00
[243]	Deactivation Event	(___/___)	(___/___)	(___/___)	00/00/00
[244]	PGM 13: Activation Event	(___/___)	(___/___)	(___/___)	00/00/00
[245]	Deactivation Event	(___/___)	(___/___)	(___/___)	00/00/00
[246]	PGM 14: Activation Event	(___/___)	(___/___)	(___/___)	00/00/00
[247]	Deactivation Event	(___/___)	(___/___)	(___/___)	00/00/00
[248]	PGM 15: Activation Event	(___/___)	(___/___)	(___/___)	00/00/00
[249]	Deactivation Event	(___/___)	(___/___)	(___/___)	00/00/00
[250]	PGM 16: Activation Event	(___/___)	(___/___)	(___/___)	00/00/00
[251]	Deactivation Event	(___/___)	(___/___)	(___/___)	00/00/00

 * Section [220] PGM 1 Activation Event **default** = (Option B Remote Assignment) Button pressed on Any remote/Any partition.
 † Section [222] PGM 2 Activation Event **default** = (Option C Remote Assignment) Button pressed on Any remote/Any partition.
See Button Options Table on page 26.

Event Description

Event Group #	Sub-group #
00 = Zone OK 01 = Zone open	01 to 32 = Zone number 99 = Any zone number
02 = Partition status	00 to 01= N/A 02 = Silent alarm 03 = Buzzer alarm 04 = Steady alarm 05 = Pulsed alarm 06 = Strobe 07 = Alarm stopped 08 = Squawk ON (Partition 1 only) 09 = Squawk OFF (Partition 1 only) 10 = Ground start (Partition 1 only) 11 = Disarm partition 12 = Arm partition 13 = Entry delay started 14 = Exit delay started 15 = Pre-alarm delay 99 = Any partition status event
03 = Bell status (Partition 1 only)	00 = Bell OFF 01 = Bell ON 02 = Bell squawk arm 03 = Bell squawk disarm 99 = Any bell status event
06 = Non-reportable event	00 = Telephone line trouble 01 = [ENTER] / [CLEAR] / [⏻] key was pressed (Partition 1 only) 02 = N/A 03 = Arm in stay mode 04 = Arm in sleep mode 05 = Arm in force mode 06 = Full arm when armed in stay mode 07 = PC fail to communicate (Partition 1 only) 08 = Utility Key 1 pressed (keys [1] and [2]) (Partition 1 only) 09 = Utility Key 2 pressed (keys [4] and [5]) (Partition 1 only) 10 = Utility Key 3 pressed (keys [7] and [8]) (Partition 1 only) 11 = Utility Key 4 pressed (keys [2] and [3]) (Partition 1 only) 12 = Utility Key 5 pressed (keys [5] and [6]) (Partition 1 only) 13 = Utility Key 6 pressed (keys [8] and [9]) (Partition 1 only) 14 = Tamper generated alarm 15 = Supervision loss generated alarm 16 = N/A 17 = N/A 18 = N/A 19 = N/A 20 = Full arm when armed in sleep mode 21 = Firmware upgrade (Partition 1 only) 99 = Any non-reportable event
07 = Remote control access 08 = Button pressed on remote (See button option "B" on page 26) 09 = Button pressed on remote (See button option "C" on page 26) 10 = Button pressed on remote (See button option "D" on page 26) 11 = Button pressed on remote (See button option "E" on page 26)	01 to 32 = Remote control number 99 = Any remote control number
12 = Cold start wireless zone	01 to 32 = Zone number 99 = Any zone number

Event Group #	Sub-group #
13 = Cold start wireless module (Partition 1 only)	01 to 16 = Output number 17 to 18 = Wireless repeater 19 to 22 = Wireless keypad 99 = Any output number
14 = Bypass programming 15 = User code activated output (Partition 1 only)	01 to 32 = User number 99 = Any user number
16 = Wireless smoke maintenance signal 17 = Delay zone alarm transmission 18 = Zone signal strength weak 1 (Partition 1 only) 19 = Zone signal strength weak 2 (Partition 1 only) 20 = Zone signal strength weak 3 (Partition 1 only) 21 = Zone signal strength weak 4 (Partition 1 only)	01 to 32 = Zone number 99 = Any zone number
24 = Fire Delay started	01 to 32 = Zone number 99 = Any zone number
25 = N/A	
26 = Software Access (VDMP3, IP100, NEware, WinLoad)	00 = Non-valid source ID 01 = WinLoad direct 02 = WinLoad through IP module 03 = Future Use 04 = WinLoad through modem 05 = NEware direct 06 = NEware through IP module 07 = Future Use 08 = NEware through modem 09 = IP100 direct 10 = VDMP3 direct 11 = Future Use
27 = Bus module event	00 = A bus module was added 01 = A bus module was removed 02 = 2-way RF Module Communication Failure 03 = 2-way RF Module Communication Restored
28 = StayD pass acknowledged	01 to 32 = Zone number 99 = Any zone number
29 = Arming with user	01 to 32 = User number 99 = Any user number
30 = Special arming	00 = Auto-arming (on time/no movement) 01 = Late to close 02 = No movement arming 03 = Partial arming 04 = Quick arming 05 = Arming through WinLoad 06 = Arming with keyswitch 99 = Any special arming
31 = Disarming with user 32 = Disarming after alarm with user 33 = Alarm cancelled with user	01 to 32 = User number 99 = Any user number
34 = Special disarming	00 = Auto-arm cancelled (on time/no movement) 01 = Disarming through WinLoad 02 = Disarming through WinLoad after alarm 03 = Alarm cancelled through WinLoad 04 = Paramedical alarm cancelled 05 = Disarm with keyswitch 06 = Disarm with keyswitch after an alarm 07 = Alarm cancelled with keyswitch 99 = Any special disarming

Event Group #	Sub-group #
35 = Zone bypassed 36 = Zone in alarm 37 = Fire alarm 38 = Zone alarm restore 39 = Fire alarm restore	01 to 32 = Zone number 99 = Any zone number
40 = Special alarm	00 = Panic non-medical emergency 01 = Panic medical (this panic alarm is not UL approved) 02 = Panic fire 03 = Recent closing 04 = Global shutdown 05 = Duress alarm 06 = Keypad lockout (Partition 1 only) 99 = Any special alarm event
41 = Zone shutdown 42 = Zone tampered 43 = Zone tamper restore	01 to 32 = Zone number 99 = Any zone number
44 = New trouble (Partition 1 only except sub-group 07 = both partitions)	00 = N/A 01 = AC failure 02 = Battery failure 03 = Auxiliary current overload 04 = Bell current overload 05 = Bell disconnected 06 = Clock loss 07 = Fire loop trouble 08 = Fail to communicate to monitoring station telephone #1 09 = Fail to communicate to monitoring station telephone #2 10 = Fail to communicate to pager report 11 = Fail to communicate to voice report 12 = RF interference 99 = Any new trouble event
45 = Trouble restored	00 = Telephone line restored 01 = AC failure restore 02 = Battery failure restore 03 = Auxiliary current overload restore 04 = Bell current overload restore 05 = Bell disconnected restore 06 = Clock loss restore 07 = Fire loop trouble restore 12 = RF interference restore 99 = Any trouble restored event
46 = Bus/wireless module new trouble (Partition 1 only)	00 = Bus communication fault 01 = Tamper trouble 02 = Power fail 03 = Battery failure 99 = Any bus module new trouble event
47 = Bus/wireless module trouble restored (Partition 1 only)	00 = Bus communication fault restore 01 = Tamper trouble restore 02 = Power fail 03 = Battery failure 99 = Any bus module trouble restored event
48 = Special (Partition 1 only)	00 = System power up 01 = Reporting test 02 = Software log on 03 = Software log off 04 = Installer in programming mode 05 = Installer exited programming mode 06 = Maintenance in programming mode 07 = Maintenance exited programming mode 08 = Closing delinquency delay elapsed 99 = Any special event

Event Group #	Sub-group #
49 = Low battery on zone 50 = Low battery on zone restore 51 = Zone supervision trouble 52 = Zone supervision restore	01 to 32 = Zone number 99 = Any zone number
53 = Wireless module supervision trouble (Partition 1 only) 54 = Wireless module supervision restore (Partition 1 only) 55 = Wireless module tamper trouble (Partition 1 only) 56 = Wireless module tamper restore (Partition 1 only)	01 to 16 = Output 17 to 18 = Wireless repeater 19 to 22 = Wireless keypad
57 = Non-medical alarm (paramedic)	01 to 32 = User number 99 = Any user number
58 = Zone forced 59 = Zone included	01 to 32 = Zone number 99 = Any zone number
64 = System Status	99 = Follow Arm LED status*: 1. PGM pulse fast in alarm 2. PGM pulse fast in exit delay below 10 sec. 3. PGM pulse slow in exit delay over 10 sec. 4. PGM steady ON if armed 5. PGM OFF if disarmed * This event can be assigned to any partition. If assigned to both partitions, the PGM event will follow the priority of the list above, with #1 being the highest priority.



Refer to the **Installer Quick Menu** on page 3 for alternate PGM programming.

Programmable Output Options

Default:	Section:	PGM 1 [261]		PGM 2 [262]		PGM 3 [263]		PGM 4 [264]	
Bold		OFF	ON	OFF	ON	OFF	ON	OFF	ON
Option									
[1]	PGM Base Time (Off=Sec; On=Min)	<input type="checkbox"/>	<input type="checkbox"/>	<input type="checkbox"/>	<input type="checkbox"/>	<input type="checkbox"/>	<input type="checkbox"/>	<input type="checkbox"/>	<input type="checkbox"/>
[2]	PGM State (Off=N.O., On=N.C.)	<input type="checkbox"/>	<input type="checkbox"/>	<input type="checkbox"/>	<input type="checkbox"/>	<input type="checkbox"/>	<input type="checkbox"/>	<input type="checkbox"/>	<input type="checkbox"/>
[3]	PGM Supervision	<input type="checkbox"/>	<input checked="" type="checkbox"/>	<input type="checkbox"/>	<input checked="" type="checkbox"/>	<input type="checkbox"/>	<input checked="" type="checkbox"/>	<input type="checkbox"/>	<input checked="" type="checkbox"/>
[4]	PGM Activation Mode (Off=Steady, On=Pulse)	<input type="checkbox"/>	<input type="checkbox"/>	<input type="checkbox"/>	<input type="checkbox"/>	<input type="checkbox"/>	<input type="checkbox"/>	<input type="checkbox"/>	<input type="checkbox"/>
[5]	PGM Pulse once every 30 seconds if armed	<input type="checkbox"/>	<input type="checkbox"/>	<input type="checkbox"/>	<input type="checkbox"/>	<input type="checkbox"/>	<input type="checkbox"/>	<input type="checkbox"/>	<input type="checkbox"/>
[6]	PGM Pulse on any alarm	<input type="checkbox"/>	<input type="checkbox"/>	<input type="checkbox"/>	<input type="checkbox"/>	<input type="checkbox"/>	<input type="checkbox"/>	<input type="checkbox"/>	<input type="checkbox"/>
[7]	PGM Pulse on any alarm - OFF= Partition 1 On= Partition 2	<input type="checkbox"/>	<input type="checkbox"/>	<input type="checkbox"/>	<input type="checkbox"/>	<input type="checkbox"/>	<input type="checkbox"/>	<input type="checkbox"/>	<input type="checkbox"/>
[8]	N/A	N/A	N/A	N/A	N/A	N/A	N/A	N/A	N/A

Default:	Section:	PGM 5 [265]		PGM 6 [266]		PGM 7 [267]		PGM 8 [268]	
Bold		OFF	ON	OFF	ON	OFF	ON	OFF	ON
Option									
[1]	PGM Base Time (Off=Sec.; On=Min.)	<input type="checkbox"/>	<input type="checkbox"/>	<input type="checkbox"/>	<input type="checkbox"/>	<input type="checkbox"/>	<input type="checkbox"/>	<input type="checkbox"/>	<input type="checkbox"/>
[2]	PGM State (Off=N.O., On= N.C.)	<input type="checkbox"/>	<input type="checkbox"/>	<input type="checkbox"/>	<input type="checkbox"/>	<input type="checkbox"/>	<input type="checkbox"/>	<input type="checkbox"/>	<input type="checkbox"/>
[3]	PGM Supervision	<input type="checkbox"/>	<input checked="" type="checkbox"/>	<input type="checkbox"/>	<input checked="" type="checkbox"/>	<input type="checkbox"/>	<input checked="" type="checkbox"/>	<input type="checkbox"/>	<input checked="" type="checkbox"/>
[4]	PGM Activation Mode (Off=Steady, ON=Pulse)	<input type="checkbox"/>	<input type="checkbox"/>	<input type="checkbox"/>	<input type="checkbox"/>	<input type="checkbox"/>	<input type="checkbox"/>	<input type="checkbox"/>	<input type="checkbox"/>
[5]	PGM Pulse once every 30 seconds if armed	<input type="checkbox"/>	<input type="checkbox"/>	<input type="checkbox"/>	<input type="checkbox"/>	<input type="checkbox"/>	<input type="checkbox"/>	<input type="checkbox"/>	<input type="checkbox"/>
[6]	PGM Pulse on any alarm	<input type="checkbox"/>	<input type="checkbox"/>	<input type="checkbox"/>	<input type="checkbox"/>	<input type="checkbox"/>	<input type="checkbox"/>	<input type="checkbox"/>	<input type="checkbox"/>
[7]	PGM Pulse on any alarm - OFF= Partition 1 On= Partition 2	<input type="checkbox"/>	<input type="checkbox"/>	<input type="checkbox"/>	<input type="checkbox"/>	<input type="checkbox"/>	<input type="checkbox"/>	<input type="checkbox"/>	<input type="checkbox"/>
[8]	N/A	N/A	N/A	N/A	N/A	N/A	N/A	N/A	N/A

Default:		PGM 9		PGM 10		PGM 11		PGM 12	
Bold		[269]		[270]		[271]		[272]	
Section:		OFF	ON	OFF	ON	OFF	ON	OFF	ON
Option									
[1]	PGM Base Time (Off=Sec; On=Min)	<input type="checkbox"/>	<input type="checkbox"/>	<input type="checkbox"/>	<input type="checkbox"/>	<input type="checkbox"/>	<input type="checkbox"/>	<input type="checkbox"/>	<input type="checkbox"/>
[2]	PGM State (Off=N.O., On=N.C.)	<input type="checkbox"/>	<input type="checkbox"/>	<input type="checkbox"/>	<input type="checkbox"/>	<input type="checkbox"/>	<input type="checkbox"/>	<input type="checkbox"/>	<input type="checkbox"/>
[3]	PGM Supervision	<input type="checkbox"/>	<input checked="" type="checkbox"/>	<input type="checkbox"/>	<input checked="" type="checkbox"/>	<input type="checkbox"/>	<input checked="" type="checkbox"/>	<input type="checkbox"/>	<input checked="" type="checkbox"/>
[4]	PGM Activation Mode (Off=Steady, On=Pulse)	<input type="checkbox"/>	<input type="checkbox"/>	<input type="checkbox"/>	<input type="checkbox"/>	<input type="checkbox"/>	<input type="checkbox"/>	<input type="checkbox"/>	<input type="checkbox"/>
[5]	PGM Pulse once every 30 seconds if armed	<input type="checkbox"/>	<input type="checkbox"/>	<input type="checkbox"/>	<input type="checkbox"/>	<input type="checkbox"/>	<input type="checkbox"/>	<input type="checkbox"/>	<input type="checkbox"/>
[6]	PGM Pulse on any alarm	<input type="checkbox"/>	<input type="checkbox"/>	<input type="checkbox"/>	<input type="checkbox"/>	<input type="checkbox"/>	<input type="checkbox"/>	<input type="checkbox"/>	<input type="checkbox"/>
[7]	PGM Pulse on any alarm - OFF= Partition 1 On= Partition 2	<input type="checkbox"/>	<input type="checkbox"/>	<input type="checkbox"/>	<input type="checkbox"/>	<input type="checkbox"/>	<input type="checkbox"/>	<input type="checkbox"/>	<input type="checkbox"/>
[8]	N/A	N/A	N/A	N/A	N/A	N/A	N/A	N/A	N/A

Default:		PGM 13		PGM 14		PGM 15		PGM 16	
Bold		[273]		[274]		[275]		[276]	
Section:		OFF	ON	OFF	ON	OFF	ON	OFF	ON
Option									
[1]	PGM Base Time (Off=Sec; On=Min)	<input type="checkbox"/>	<input type="checkbox"/>	<input type="checkbox"/>	<input type="checkbox"/>	<input type="checkbox"/>	<input type="checkbox"/>	<input type="checkbox"/>	<input type="checkbox"/>
[2]	PGM State (Off=N.O., On=N.C.)	<input type="checkbox"/>	<input type="checkbox"/>	<input type="checkbox"/>	<input type="checkbox"/>	<input type="checkbox"/>	<input type="checkbox"/>	<input type="checkbox"/>	<input type="checkbox"/>
[3]	PGM Supervision	<input type="checkbox"/>	<input checked="" type="checkbox"/>	<input type="checkbox"/>	<input checked="" type="checkbox"/>	<input type="checkbox"/>	<input checked="" type="checkbox"/>	<input type="checkbox"/>	<input checked="" type="checkbox"/>
[4]	PGM Activation Mode (Off=Steady, On=Pulse)	<input type="checkbox"/>	<input type="checkbox"/>	<input type="checkbox"/>	<input type="checkbox"/>	<input type="checkbox"/>	<input type="checkbox"/>	<input type="checkbox"/>	<input type="checkbox"/>
[5]	PGM Pulse once every 30 seconds if armed	<input type="checkbox"/>	<input type="checkbox"/>	<input type="checkbox"/>	<input type="checkbox"/>	<input type="checkbox"/>	<input type="checkbox"/>	<input type="checkbox"/>	<input type="checkbox"/>
[6]	PGM Pulse on any alarm	<input type="checkbox"/>	<input type="checkbox"/>	<input type="checkbox"/>	<input type="checkbox"/>	<input type="checkbox"/>	<input type="checkbox"/>	<input type="checkbox"/>	<input type="checkbox"/>
[7]	PGM Pulse on any alarm - OFF= Partition 1 On= Partition 2	<input type="checkbox"/>	<input type="checkbox"/>	<input type="checkbox"/>	<input type="checkbox"/>	<input type="checkbox"/>	<input type="checkbox"/>	<input type="checkbox"/>	<input type="checkbox"/>
[8]	N/A	N/A	N/A	N/A	N/A	N/A	N/A	N/A	N/A

Programmable Output Delays

Section	MG5000/SP5500/SP6000	Data	Default = 005	MG5050/SP7000	Data	Default = 005
[281]	PGM 1*†:	___/___/___ (000 to 255 x 1 sec./mins.)		___/___/___ (000 to 255 x 1 sec./mins.)		
[282]	PGM 2*†:	___/___/___ (000 to 255 x 1 sec./mins.)		___/___/___ (000 to 255 x 1 sec./mins.)		
[283]	PGM 3†:	___/___/___ (001 / 005 / 015 / 030 x 1 sec./mins.)		___/___/___ (000 to 255 x 1 sec./mins.)		
[284]	PGM 4†:	___/___/___ (001 / 005 / 015 / 030 x 1 sec./mins.)		___/___/___ (000 to 255 x 1 sec./mins.)		
[285]	PGM 5**:	___/___/___ (001 / 005 / 015 / 030 x 1 sec./mins.)		___/___/___ (001 / 005 / 015 / 030 x 1 sec./mins.)		
[286]	PGM 6:	___/___/___ (001 / 005 / 015 / 030 x 1 sec./mins.)		___/___/___ (001 / 005 / 015 / 030 x 1 sec./mins.)		
[287]	PGM 7:	___/___/___ (001 / 005 / 015 / 030 x 1 sec./mins.)		___/___/___ (001 / 005 / 015 / 030 x 1 sec./mins.)		
[288]	PGM 8:	___/___/___ (001 / 005 / 015 / 030 x 1 sec./mins.)		___/___/___ (001 / 005 / 015 / 030 x 1 sec./mins.)		
[289]	PGM 9:	___/___/___ (001 / 005 / 015 / 030 x 1 sec./mins.)		___/___/___ (001 / 005 / 015 / 030 x 1 sec./mins.)		
[290]	PGM 10:	___/___/___ (001 / 005 / 015 / 030 x 1 sec./mins.)		___/___/___ (001 / 005 / 015 / 030 x 1 sec./mins.)		
[291]	PGM 11:	___/___/___ (001 / 005 / 015 / 030 x 1 sec./mins.)		___/___/___ (001 / 005 / 015 / 030 x 1 sec./mins.)		
[292]	PGM 12:	___/___/___ (001 / 005 / 015 / 030 x 1 sec./mins.)		___/___/___ (001 / 005 / 015 / 030 x 1 sec./mins.)		
[293]	PGM 13:	___/___/___ (001 / 005 / 015 / 030 x 1 sec./mins.)		___/___/___ (001 / 005 / 015 / 030 x 1 sec./mins.)		
[294]	PGM 14:	___/___/___ (001 / 005 / 015 / 030 x 1 sec./mins.)		___/___/___ (001 / 005 / 015 / 030 x 1 sec./mins.)		
[295]	PGM 15:	___/___/___ (001 / 005 / 015 / 030 x 1 sec./mins.)		___/___/___ (001 / 005 / 015 / 030 x 1 sec./mins.)		
[296]	PGM 16:	___/___/___ (001 / 005 / 015 / 030 x 1 sec./mins.)		___/___/___ (001 / 005 / 015 / 030 x 1 sec./mins.)		

* = hardwired - MG5000 / SP5500 / SP6000 † = hardwired - MG5050 / SP6000 (optional) / SP7000

** = on-board relay - SP6000 (optional) / SP7000

PGMs Serial Number

Section	Wireless PGM Serial Number	Section	Wireless PGM Serial Number
[301]	PGM 1: _____	[309]	PGM 9: _____
[302]	PGM 2: _____	[310]	PGM 10: _____
[303]	PGM 3: _____	[311]	PGM 11: _____
[304]	PGM 4: _____	[312]	PGM 12: _____
[305]	PGM 5: _____	[313]	PGM 13: _____
[306]	PGM 6: _____	[314]	PGM 14: _____
[307]	PGM 7: _____	[315]	PGM 15: _____
[308]	PGM 8: _____	[316]	PGM 16: _____



To delete a wireless PGM, enter [000000] in its respective section.
 To view the serial number display, refer to section [960].
 For automatic assignment, press the PGM's anti-tamper switch while in the respective section.



Refer to the **Installer Quick Menu** on page 3 for alternate PGM programming.

Wireless PGM Signal Strength

Section	Section
[321] PGM 1 Wireless PGM Signal Strength	[329] PGM 9 Wireless PGM Signal Strength
[322] PGM 2 Wireless PGM Signal Strength	[330] PGM 10 Wireless PGM Signal Strength
[323] PGM 3 Wireless PGM Signal Strength	[331] PGM 11 Wireless PGM Signal Strength
[324] PGM 4 Wireless PGM Signal Strength	[332] PGM 12 Wireless PGM Signal Strength
[325] PGM 5 Wireless PGM Signal Strength	[333] PGM 13 Wireless PGM Signal Strength
[326] PGM 6 Wireless PGM Signal Strength	[334] PGM 14 Wireless PGM Signal Strength
[327] PGM 7 Wireless PGM Signal Strength	[335] PGM 15 Wireless PGM Signal Strength
[328] PGM 8 Wireless PGM Signal Strength	[336] PGM 16 Wireless PGM Signal Strength

Signal Strength Indicator	8 to 10 / 3 beeps = Best signal	5 to 7 / 2 beeps = Average signal	1 to 4 / 1 beep = Weak signal (Relocate)
----------------------------------	---------------------------------	-----------------------------------	--



To view the wireless PGM signal strength, press the wireless PGM's anti-tamper switch while in the respective section.

PGM Recognition

	MG5000/SP5500/SP6000	MG5050/SP7000
PGM 1	Control Panel Output 1	Control Panel Output 1
PGM 2	Control Panel Output 2	Control Panel Output 2
PGM 3	N/A	Control Panel Output 3
PGM 4	N/A	Control Panel Output 4
PGM 5	N/A	Control Panel Relay
PGM 6	ZX8 ID= 1 Output	ZX8 ID= 1 Output
PGM 7	ZX8 ID= 2 Output	ZX8 ID= 2 Output
PGM 8	ZX8 ID= 3 Output	ZX8 ID= 3 Output
PGM 9	N/A	N/A
PGM 10	N/A	N/A
PGM 11	N/A	N/A
PGM 12	N/A	N/A
PGM 13	RTX3 Output 1	RTX3 Output 1
PGM 14	RTX3 Output 2	RTX3 Output 2
PGM 15	RTX3 Output 3	RTX3 Output 3
PGM 16	RTX3 Output 4	RTX3 Output 4



A Wireless PGM module can be assigned to any PGM. It will work in parallel with the Control Panel Output.

User Programming



Refer to the **Installer Quick Menu** on page 3 for installer or maintenance code programming.
 Refer to the **Master Quick Menu** in the User Guide for user code/remote control programming.

System Codes

Section	Data	Description
[395]	___/___/___ (147 to lock, other to unlock)	Installer Code Lock (default 000)
[397]	___/___/___/___/___/___	Installer Code (default = 000000)*
[398]	___/___/___/___/___/___	Maintenance Code (no default)
[399]	___/___/___/___/___/___	System Master Code (default = 123456)*

*4 or 6 digits according to section [701] option [1]. The control panel automatically removes the last 2 digits of the user access code if the length is changed from 6 digits to 4 digits. However, if the user access code length is changed from 4 to 6 digits, the control panel adds 2 digits to the end by using the first two digits.

Maintenance Code Limited Access Table			
These are the sections that the Maintenance Code cannot access:			
[395]	Installer code lock	[816]	Monitoring station telephone number 2
[397]	Installer code	[817]	Backup monitoring station telephone
[398]	Maintenance code	[910]	Panel ID
[815]	Monitoring station telephone number 1	[911]	PC password

User Code Options

User Options

1 - Partition 1 Access

2 - Partition 2 Access

3 - Bypass Programming

4 - Stay/Sleep Arming

5 - Force Arming (Regular/Sleep/StayArming)

6 - Arm Only

7 - PGM Activation Only

8 - Duress



When section [400] is accessed, the panel will copy the saved value of that section to all user options- [404] to [432].

Section	Options	Section	Options
[400] Default Option	1 2 3 4 5 6 7 8	[417] User 17:	1 2 3 4 5 6 7 8
[401] System Master:	① ② ③ ④ ⑤ 6 7 8	[418] User 18:	1 2 3 4 5 6 7 8
[402] Master 1:	① 2 ③ ④ ⑤ 6 7 8	[419] User 19:	1 2 3 4 5 6 7 8
[403] Master 2:	1 ② ③ ④ ⑤ 6 7 8	[420] User 20:	1 2 3 4 5 6 7 8
[404] User 4:	1 2 3 4 5 6 7 8	[421] User 21:	1 2 3 4 5 6 7 8
[405] User 5:	1 2 3 4 5 6 7 8	[422] User 22:	1 2 3 4 5 6 7 8
[406] User 6:	1 2 3 4 5 6 7 8	[423] User 23:	1 2 3 4 5 6 7 8
[407] User 7:	1 2 3 4 5 6 7 8	[424] User 24:	1 2 3 4 5 6 7 8
[408] User 8:	1 2 3 4 5 6 7 8	[425] User 25:	1 2 3 4 5 6 7 8
[409] User 9:	1 2 3 4 5 6 7 8	[426] User 26:	1 2 3 4 5 6 7 8
[410] User 10:	1 2 3 4 5 6 7 8	[427] User 27:	1 2 3 4 5 6 7 8
[411] User 11:	1 2 3 4 5 6 7 8	[428] User 28:	1 2 3 4 5 6 7 8
[412] User 12:	1 2 3 4 5 6 7 8	[429] User 29:	1 2 3 4 5 6 7 8
[413] User 13:	1 2 3 4 5 6 7 8	[430] User 30:	1 2 3 4 5 6 7 8
[414] User 14:	1 2 3 4 5 6 7 8	[431] User 31:	1 2 3 4 5 6 7 8
[415] User 15:	1 2 3 4 5 6 7 8	[432] User 32:	1 2 3 4 5 6 7 8
[416] User 16:	1 2 3 4 5 6 7 8		



The System Master, Master 1, and Master 2 user code options cannot be modified. However, if partitioning is not enabled, the user code options for Master 2 will match those of Master 1.

User Reporting Codes (Default = FF)

Section	Arming	Disarming/Cancel Alarm	Section	Arming	Disarming/Cancel Alarm
[471] S. Master:	___/___	___/___	[487] User 17:	___/___	___/___
[472] Master 1:	___/___	___/___	[488] User 18:	___/___	___/___
[473] Master 2:	___/___	___/___	[489] User 19:	___/___	___/___
[474] User 4:	___/___	___/___	[490] User 20:	___/___	___/___
[475] User 5:	___/___	___/___	[491] User 21:	___/___	___/___
[476] User 6:	___/___	___/___	[492] User 22:	___/___	___/___
[477] User 7:	___/___	___/___	[493] User 23:	___/___	___/___
[478] User 8:	___/___	___/___	[494] User 24:	___/___	___/___
[479] User 9:	___/___	___/___	[495] User 25:	___/___	___/___
[480] User 10:	___/___	___/___	[496] User 26:	___/___	___/___
[481] User 11:	___/___	___/___	[497] User 27:	___/___	___/___
[482] User 12:	___/___	___/___	[498] User 28:	___/___	___/___
[483] User 13:	___/___	___/___	[499] User 29:	___/___	___/___
[484] User 14:	___/___	___/___	[500] User 30:	___/___	___/___
[485] User 15:	___/___	___/___	[501] User 31:	___/___	___/___
[486] User 16:	___/___	___/___	[502] User 32:	___/___	___/___



Refer to *Decimal and Hexadecimal Values* on page 50.

Remote Control (RC) User Assignment

Section	Remote Serial Number	Section	Remote Serial Number
[651] RC 1 for User 1:	___/___/___/___/___/___	[667] RC 17 for User 17:	___/___/___/___/___/___
[652] RC 2 for User 2:	___/___/___/___/___/___	[668] RC 18 for User 18:	___/___/___/___/___/___
[653] RC 3 for User 3:	___/___/___/___/___/___	[669] RC 19 for User 19:	___/___/___/___/___/___
[654] RC 4 for User 4:	___/___/___/___/___/___	[670] RC 20 for User 20:	___/___/___/___/___/___
[655] RC 5 for User 5:	___/___/___/___/___/___	[671] RC 21 for User 21:	___/___/___/___/___/___
[656] RC 6 for User 6:	___/___/___/___/___/___	[672] RC 22 for User 22:	___/___/___/___/___/___
[657] RC 7 for User 7:	___/___/___/___/___/___	[673] RC 23 for User 23:	___/___/___/___/___/___
[658] RC 8 for User 8:	___/___/___/___/___/___	[674] RC 24 for User 24:	___/___/___/___/___/___
[659] RC 9 for User 9:	___/___/___/___/___/___	[675] RC 25 for User 25:	___/___/___/___/___/___
[660] RC 10 for User 10:	___/___/___/___/___/___	[676] RC 26 for User 26:	___/___/___/___/___/___
[661] RC 11 for User 11:	___/___/___/___/___/___	[677] RC 27 for User 27:	___/___/___/___/___/___
[662] RC 12 for User 12:	___/___/___/___/___/___	[678] RC 28 for User 28:	___/___/___/___/___/___
[663] RC 13 for User 13:	___/___/___/___/___/___	[679] RC 29 for User 29:	___/___/___/___/___/___
[664] RC 14 for User 14:	___/___/___/___/___/___	[680] RC 30 for User 30:	___/___/___/___/___/___
[665] RC 15 for User 15:	___/___/___/___/___/___	[681] RC 31 for User 31:	___/___/___/___/___/___
[666] RC 16 for User 16:	___/___/___/___/___/___	[682] RC 32 for User 32:	___/___/___/___/___/___







To delete a remote control, enter [000000] in its respective section. To view the serial number display, refer to section [960]. This section of the programming guide is for viewing the assigned remote control's serial number only. For automatic assignment, press a button on the designated remote while in the respective section.



Refer to the **Master Quick Menu** in the User Guide for user code/remote control programming.

Remote Button Assignment

RC#						Future Use	Future Use	Future Use	Future Use
[610]	Default	_____	_____	_____	_____	_____	_____	_____	_____
IMPORTANT: When section [610] is accessed, the panel will copy the saved value of that section to all remotes.									
[611]	1	_____	_____	_____	_____	_____	_____	_____	_____
[612]	2	_____	_____	_____	_____	_____	_____	_____	_____
[613]	3	_____	_____	_____	_____	_____	_____	_____	_____
[614]	4	_____	_____	_____	_____	_____	_____	_____	_____
[615]	5	_____	_____	_____	_____	_____	_____	_____	_____
[616]	6	_____	_____	_____	_____	_____	_____	_____	_____
[617]	7	_____	_____	_____	_____	_____	_____	_____	_____
[618]	8	_____	_____	_____	_____	_____	_____	_____	_____
[619]	9	_____	_____	_____	_____	_____	_____	_____	_____
[620]	10	_____	_____	_____	_____	_____	_____	_____	_____
[621]	11	_____	_____	_____	_____	_____	_____	_____	_____
[622]	12	_____	_____	_____	_____	_____	_____	_____	_____
[623]	13	_____	_____	_____	_____	_____	_____	_____	_____
[624]	14	_____	_____	_____	_____	_____	_____	_____	_____
[625]	15	_____	_____	_____	_____	_____	_____	_____	_____
[626]	16	_____	_____	_____	_____	_____	_____	_____	_____
[627]	17	_____	_____	_____	_____	_____	_____	_____	_____
[628]	18	_____	_____	_____	_____	_____	_____	_____	_____
[629]	19	_____	_____	_____	_____	_____	_____	_____	_____
[630]	20	_____	_____	_____	_____	_____	_____	_____	_____
[631]	21	_____	_____	_____	_____	_____	_____	_____	_____
[632]	22	_____	_____	_____	_____	_____	_____	_____	_____
[633]	23	_____	_____	_____	_____	_____	_____	_____	_____
[634]	24	_____	_____	_____	_____	_____	_____	_____	_____
[635]	25	_____	_____	_____	_____	_____	_____	_____	_____
[636]	26	_____	_____	_____	_____	_____	_____	_____	_____
[637]	27	_____	_____	_____	_____	_____	_____	_____	_____
[638]	28	_____	_____	_____	_____	_____	_____	_____	_____
[639]	29	_____	_____	_____	_____	_____	_____	_____	_____
[640]	30	_____	_____	_____	_____	_____	_____	_____	_____
[641]	31	_____	_____	_____	_____	_____	_____	_____	_____
[642]	32	_____	_____	_____	_____	_____	_____	_____	_____

Button Options Table (refer to Decimal and Hexadecimal Values on page 50)

- [SLEEP] - Empty / Button disabled
- [1] - Regular / Regular Force arming
- [2] - Stay / Stay Force arming
- [3] - N/A
- [4] - Sleep / Sleep Force arming
- [5] - N/A
- [6] - N/A
- [7] - N/A
- [8] - Panic 1
- [9] - Panic 2

- [A] - Panic 3
- [B] - PGM Activation (Event Group #8)*
- [C] - PGM Activation (Event Group #9)*
- [D] - PGM Activation (Event Group #10)*
- [E] - PGM Activation (Event Group #11)*
- [F] - Paramedic alarm

* See PGM Programming on page 17.



The disarm () button cannot be modified.

Remote Controls Supported
MG-REM1 / MG-RAC1 / MG-REM2

2-Way Remote Indicators (MG-REM2)

Full/Force Arming Indicators

Action	LED Sequence	Auditory Sequence
Disarming	Green on	Two beeps
Exit delay	Red / green slow flash	Confirmation beep
Arming / Entry Delay	Red on	Confirmation beep
Alarm	Red fast flash	Alarm beep

Stay/Sleep Arming Indicators

Action	LED Sequence	Auditory Sequence
Disarming	Green on	Two beeps
Exit delay	Yellow / green slow flash	Confirmation beep
Arming / Entry Delay	Yellow on	Confirmation beep
Alarm	Red fast flash	Alarm beep

Other Indicators

Action	LED Sequence	Auditory Sequence
PGM on/off	Yellow on	Confirmation beep

Wireless Repeater Programming (MG-RPT1)

Wireless Repeater Assignment

Section	Wireless Repeater Serial Number
[545]	Repeater 1 ___/___/___/___/___/___/___/___
[546]	Repeater 2 ___/___/___/___/___/___/___/___



For automatic assignment, press the wireless repeater's anti-tamper switch while in the respective section.

Wireless Repeater Signal Strength

Section
[548] Wireless Repeater 1 Signal Strength
[549] Wireless Repeater 2 Signal Strength

Signal Strength Indicator	8 to 10 / 3 beeps = Best signal	5 to 7 / 2 beeps = Average signal	1 to 4 / 1 beep = Weak signal (Relocate)
---------------------------	---------------------------------	-----------------------------------	--



To view the wireless repeater's signal strength, press the wireless repeater's anti-tamper switch while in the respective section.

Wireless Repeater Options

Default: Bold	Section:	MG-RPT1 #1 [551]		MG-RPT1 #2 [561]	
Option		OFF	ON	OFF	ON
[1] Repeat Wireless Keypad 1 Signals		<input type="checkbox"/>	<input type="checkbox"/>	<input type="checkbox"/>	<input type="checkbox"/>
[2] Repeat Wireless Keypad 2 Signals		<input type="checkbox"/>	<input type="checkbox"/>	<input type="checkbox"/>	<input type="checkbox"/>
[3] Repeat Wireless Keypad 3 Signals		<input type="checkbox"/>	<input type="checkbox"/>	<input type="checkbox"/>	<input type="checkbox"/>
[4] Repeat Wireless Keypad 4 Signals		<input type="checkbox"/>	<input type="checkbox"/>	<input type="checkbox"/>	<input type="checkbox"/>
[5] Repeat Wireless Keypad 5 Signals		<input type="checkbox"/>	<input type="checkbox"/>	<input type="checkbox"/>	<input type="checkbox"/>
[6] Repeat Wireless Keypad 6 Signals		<input type="checkbox"/>	<input type="checkbox"/>	<input type="checkbox"/>	<input type="checkbox"/>
[7] Repeat Wireless Keypad 7 Signals		<input type="checkbox"/>	<input type="checkbox"/>	<input type="checkbox"/>	<input type="checkbox"/>
[8] Repeat Wireless Keypad 8 Signals		<input type="checkbox"/>	<input type="checkbox"/>	<input type="checkbox"/>	<input type="checkbox"/>

Default: Bold	Section:	MG-RPT1 #1 [552]		MG-RPT1 #2 [562]	
Option		OFF	ON	OFF	ON
[1] Repeat Wireless Zone 1 Signals		<input type="checkbox"/>	<input type="checkbox"/>	<input type="checkbox"/>	<input type="checkbox"/>
[2] Repeat Wireless Zone 2 Signals		<input type="checkbox"/>	<input type="checkbox"/>	<input type="checkbox"/>	<input type="checkbox"/>
[3] Repeat Wireless Zone 3 Signals		<input type="checkbox"/>	<input type="checkbox"/>	<input type="checkbox"/>	<input type="checkbox"/>
[4] Repeat Wireless Zone 4 Signals		<input type="checkbox"/>	<input type="checkbox"/>	<input type="checkbox"/>	<input type="checkbox"/>
[5] Repeat Wireless Zone 5 Signals		<input type="checkbox"/>	<input type="checkbox"/>	<input type="checkbox"/>	<input type="checkbox"/>
[6] Repeat Wireless Zone 6 Signals		<input type="checkbox"/>	<input type="checkbox"/>	<input type="checkbox"/>	<input type="checkbox"/>
[7] Repeat Wireless Zone 7 Signals		<input type="checkbox"/>	<input type="checkbox"/>	<input type="checkbox"/>	<input type="checkbox"/>
[8] Repeat Wireless Zone 8 Signals		<input type="checkbox"/>	<input type="checkbox"/>	<input type="checkbox"/>	<input type="checkbox"/>

Default:		MG-RPT1 #1		MG-RPT1 #2	
Bold	Section:	[553]		[563]	
Option		OFF	ON	OFF	ON
[1]	Repeat Wireless Zone 9 Signals	<input type="checkbox"/>	<input type="checkbox"/>	<input type="checkbox"/>	<input type="checkbox"/>
[2]	Repeat Wireless Zone 10 Signals	<input type="checkbox"/>	<input type="checkbox"/>	<input type="checkbox"/>	<input type="checkbox"/>
[3]	Repeat Wireless Zone 11 Signals	<input type="checkbox"/>	<input type="checkbox"/>	<input type="checkbox"/>	<input type="checkbox"/>
[4]	Repeat Wireless Zone 12 Signals	<input type="checkbox"/>	<input type="checkbox"/>	<input type="checkbox"/>	<input type="checkbox"/>
[5]	Repeat Wireless Zone 13 Signals	<input type="checkbox"/>	<input type="checkbox"/>	<input type="checkbox"/>	<input type="checkbox"/>
[6]	Repeat Wireless Zone 14 Signals	<input type="checkbox"/>	<input type="checkbox"/>	<input type="checkbox"/>	<input type="checkbox"/>
[7]	Repeat Wireless Zone 15 Signals	<input type="checkbox"/>	<input type="checkbox"/>	<input type="checkbox"/>	<input type="checkbox"/>
[8]	Repeat Wireless Zone 16 Signals	<input type="checkbox"/>	<input type="checkbox"/>	<input type="checkbox"/>	<input type="checkbox"/>

Default:		MG-RPT1 #1		MG-RPT1 #2	
Bold	Section:	[554]		[564]	
Option		OFF	ON	OFF	ON
[1]	Repeat Wireless Zone 17 Signals	<input type="checkbox"/>	<input type="checkbox"/>	<input type="checkbox"/>	<input type="checkbox"/>
[2]	Repeat Wireless Zone 18 Signals	<input type="checkbox"/>	<input type="checkbox"/>	<input type="checkbox"/>	<input type="checkbox"/>
[3]	Repeat Wireless Zone 19 Signals	<input type="checkbox"/>	<input type="checkbox"/>	<input type="checkbox"/>	<input type="checkbox"/>
[4]	Repeat Wireless Zone 20 Signals	<input type="checkbox"/>	<input type="checkbox"/>	<input type="checkbox"/>	<input type="checkbox"/>
[5]	Repeat Wireless Zone 21 Signals	<input type="checkbox"/>	<input type="checkbox"/>	<input type="checkbox"/>	<input type="checkbox"/>
[6]	Repeat Wireless Zone 22 Signals	<input type="checkbox"/>	<input type="checkbox"/>	<input type="checkbox"/>	<input type="checkbox"/>
[7]	Repeat Wireless Zone 23 Signals	<input type="checkbox"/>	<input type="checkbox"/>	<input type="checkbox"/>	<input type="checkbox"/>
[8]	Repeat Wireless Zone 24 Signals	<input type="checkbox"/>	<input type="checkbox"/>	<input type="checkbox"/>	<input type="checkbox"/>

Default:		MG-RPT1 #1		MG-RPT1 #2	
Bold	Section:	[555]		[565]	
Option		OFF	ON	OFF	ON
[1]	Repeat Wireless Zone 25 Signals	<input type="checkbox"/>	<input type="checkbox"/>	<input type="checkbox"/>	<input type="checkbox"/>
[2]	Repeat Wireless Zone 26 Signals	<input type="checkbox"/>	<input type="checkbox"/>	<input type="checkbox"/>	<input type="checkbox"/>
[3]	Repeat Wireless Zone 27 Signals	<input type="checkbox"/>	<input type="checkbox"/>	<input type="checkbox"/>	<input type="checkbox"/>
[4]	Repeat Wireless Zone 28 Signals	<input type="checkbox"/>	<input type="checkbox"/>	<input type="checkbox"/>	<input type="checkbox"/>
[5]	Repeat Wireless Zone 29 Signals	<input type="checkbox"/>	<input type="checkbox"/>	<input type="checkbox"/>	<input type="checkbox"/>
[6]	Repeat Wireless Zone 30 Signals	<input type="checkbox"/>	<input type="checkbox"/>	<input type="checkbox"/>	<input type="checkbox"/>
[7]	Repeat Wireless Zone 31 Signals	<input type="checkbox"/>	<input type="checkbox"/>	<input type="checkbox"/>	<input type="checkbox"/>
[8]	Repeat Wireless Zone 32 Signals	<input type="checkbox"/>	<input type="checkbox"/>	<input type="checkbox"/>	<input type="checkbox"/>

Default:		MG-RPT1 #1		MG-RPT1 #2	
Bold		[556]		[566]	
Option	Section:	OFF	ON	OFF	ON
[1]	Repeat Wireless 2-Way PGM 1 Signals	<input type="checkbox"/>	<input type="checkbox"/>	<input type="checkbox"/>	<input type="checkbox"/>
[2]	Repeat Wireless 2-Way PGM 2 Signals	<input type="checkbox"/>	<input type="checkbox"/>	<input type="checkbox"/>	<input type="checkbox"/>
[3]	Repeat Wireless 2-Way PGM 3 Signals	<input type="checkbox"/>	<input type="checkbox"/>	<input type="checkbox"/>	<input type="checkbox"/>
[4]	Repeat Wireless 2-Way PGM 4 Signals	<input type="checkbox"/>	<input type="checkbox"/>	<input type="checkbox"/>	<input type="checkbox"/>
[5]	Repeat Wireless 2-Way PGM 5 Signals	<input type="checkbox"/>	<input type="checkbox"/>	<input type="checkbox"/>	<input type="checkbox"/>
[6]	Repeat Wireless 2-Way PGM 6 Signals	<input type="checkbox"/>	<input type="checkbox"/>	<input type="checkbox"/>	<input type="checkbox"/>
[7]	Repeat Wireless 2-Way PGM 7 Signals	<input type="checkbox"/>	<input type="checkbox"/>	<input type="checkbox"/>	<input type="checkbox"/>
[8]	Repeat Wireless 2-Way PGM 8 Signals	<input type="checkbox"/>	<input type="checkbox"/>	<input type="checkbox"/>	<input type="checkbox"/>

Default:		MG-RPT1 #1		MG-RPT1 #2	
Bold		[557]		[567]	
Option	Section:	OFF	ON	OFF	ON
[1]	Repeat Wireless 2-Way PGM 9 Signals	<input type="checkbox"/>	<input type="checkbox"/>	<input type="checkbox"/>	<input type="checkbox"/>
[2]	Repeat Wireless 2-Way PGM 10 Signals	<input type="checkbox"/>	<input type="checkbox"/>	<input type="checkbox"/>	<input type="checkbox"/>
[3]	Repeat Wireless 2-Way PGM 11 Signals	<input type="checkbox"/>	<input type="checkbox"/>	<input type="checkbox"/>	<input type="checkbox"/>
[4]	Repeat Wireless 2-Way PGM 12 Signals	<input type="checkbox"/>	<input type="checkbox"/>	<input type="checkbox"/>	<input type="checkbox"/>
[5]	Repeat Wireless 2-Way PGM 13 Signals	<input type="checkbox"/>	<input type="checkbox"/>	<input type="checkbox"/>	<input type="checkbox"/>
[6]	Repeat Wireless 2-Way PGM 14 Signals	<input type="checkbox"/>	<input type="checkbox"/>	<input type="checkbox"/>	<input type="checkbox"/>
[7]	Repeat Wireless 2-Way PGM 15 Signals	<input type="checkbox"/>	<input type="checkbox"/>	<input type="checkbox"/>	<input type="checkbox"/>
[8]	Repeat Wireless 2-Way PGM 16 Signals	<input type="checkbox"/>	<input type="checkbox"/>	<input type="checkbox"/>	<input type="checkbox"/>



Remote control signals are always repeated.

Wireless Keypad Programming (MG32LRF)



For standard keypad programming, see page 16.

Automatic Wireless Keypad Assignment

After panel power-up, the control panel will open a 10 minute window for Automatic Assignment. Press and hold the [⏏] and [BYP] key for three seconds on the respective keypad. The keypad is assigned to the control panel. Up to 8 wireless keypads can be assigned within the ten minute window.

Standard Wireless Keypad Assignment

Section	Wireless Keypad Serial Number
[571]	Keypad 1 ___/___/___/___/___/___
[572]	Keypad 2 ___/___/___/___/___/___
[573]	Keypad 3 ___/___/___/___/___/___
[574]	Keypad 4 ___/___/___/___/___/___
[575]	Keypad 5 ___/___/___/___/___/___
[576]	Keypad 6 ___/___/___/___/___/___
[577]	Keypad 7 ___/___/___/___/___/___
[578]	Keypad 8 ___/___/___/___/___/___



Enter serial number or press and hold the [⏏] and [BYP] key for three seconds.

Wireless Keypad Signal Strength

Section	
[591]	Wireless Keypad 1 Signal Strength
[592]	Wireless Keypad 2 Signal Strength
[593]	Wireless Keypad 3 Signal Strength
[594]	Wireless Keypad 4 Signal Strength
[595]	Wireless Keypad 5 Signal Strength
[596]	Wireless Keypad 6 Signal Strength
[597]	Wireless Keypad 7 Signal Strength
[598]	Wireless Keypad 8 Signal Strength

Signal Strength Indicator	8 to 10 / 3 beeps = Best signal	5 to 7 / 2 beeps = Average signal	1 to 4 / 1 beep = Weak signal (Relocate)
---------------------------	---------------------------------	-----------------------------------	--



To view the wireless keypad's signal strength, press the [⚙] key.

Wireless Repeater/Keypad Options

[587]	Wireless Repeater / Keypad Options	Bold = Default setting	
	Option	OFF	ON
[1]	Repeater 1 Supervision	<input type="checkbox"/> Disabled	<input type="checkbox"/> Enabled
[2]	Repeater 2 Supervision	<input type="checkbox"/> Disabled	<input type="checkbox"/> Enabled
[3] to [7]	N/A	N/A	N/A
[8]	Live Display Mode	<input type="checkbox"/> Disabled	<input type="checkbox"/> Enabled

Option	OFF	ON
[1] Keypad 1 Supervision	<input type="checkbox"/> Disabled	<input type="checkbox"/> Enabled
[2] Keypad 2 Supervision	<input type="checkbox"/> Disabled	<input type="checkbox"/> Enabled
[3] Keypad 3 Supervision	<input type="checkbox"/> Disabled	<input type="checkbox"/> Enabled
[4] Keypad 4 Supervision	<input type="checkbox"/> Disabled	<input type="checkbox"/> Enabled
[5] Keypad 5 Supervision	<input type="checkbox"/> Disabled	<input type="checkbox"/> Enabled
[6] Keypad 6 Supervision	<input type="checkbox"/> Disabled	<input type="checkbox"/> Enabled
[7] Keypad 7 Supervision	<input type="checkbox"/> Disabled	<input type="checkbox"/> Enabled
[8] Keypad 8 Supervision	<input type="checkbox"/> Disabled	<input type="checkbox"/> Enabled

LCD Keypad Labels (MG32LCD)

Input Keys

Special Function Keys	
Key	Function
[STAY]	Insert space
[SLEEP]	Delete
[ARM]	Delete whole entry
[OFF]	Toggle numeric/alphanumeric keys
[BYP]	Toggle lower case/upper case
[MEM]	Special characters

Alphanumeric Key Input	
[1]	A / B / C
[2]	D / E / F
[3]	G / H / I
[4]	J / K / L
[5]	M / N / O
[6]	P / Q / R
[7]	S / T / U
[8]	V / W / X
[9]	Y / Z

Special Characters and Keypad Letter Assignment

Polish / Hungarian / Turkish Special Character Catalogue

Polish	⁰⁰¹ ą	⁰⁰² ć	⁰⁰³ ą	⁰⁰⁴ ę	⁰⁰⁵ ż	⁰⁰⁶ ł	⁰⁰⁷ ś
Hungarian	⁰⁰¹ Á	⁰⁰² ű	⁰⁰³ Ő				
Turkish	⁰⁰¹ ü						

Special Character Catalogue

⁰³² 0	⁰⁴⁸ @	⁰⁶⁴ P	⁰⁸⁰ `	⁰⁹⁶ p	¹¹² Û	¹²⁸ Ê	¹⁴⁴ Æ	¹⁶⁰ \$	¹⁷⁶ Ø	¹⁹² •	²⁰⁸ .
⁰³³ !	⁰⁴⁹ 1	⁰⁶⁵ A	⁰⁸¹ Q	⁰⁹⁷ a	¹¹³ ù	¹²⁹ È	¹⁴⁵ Æ	¹⁶¹ §	¹⁷⁷ ±	¹⁹³ ™	²⁰⁹ " ' °
⁰³⁴ " ' °	⁰⁵⁰ 2	⁰⁶⁶ B	⁰⁸² R	⁰⁹⁸ b	¹¹⁴ r	¹³⁰ Ú	¹⁴⁶ Ī	¹⁶² ĩ	¹⁷⁸ ĩ	¹⁹⁴ Đ	²¹⁰ °
⁰³⁵ #	⁰⁵¹ 3	⁰⁶⁷ C	⁰⁸³ S	⁰⁹⁹ c	¹¹⁵ s	¹³¹ Ü	¹⁴⁷ Ê	¹⁶³ í	¹⁷⁹ ↑	¹⁹⁵ ß	²¹¹ `
⁰³⁶ \$	⁰⁵² 4	⁰⁶⁸ D	⁰⁸⁴ T	¹⁰⁰ d	¹¹⁶ t	¹³² Û	¹⁴⁸ ê	¹⁶⁴ ĩ	¹⁸⁰ ↓	¹⁹⁶ ç	²¹² ´
⁰³⁷ %	⁰⁵³ 5	⁰⁶⁹ E	⁰⁸⁵ U	¹⁰¹ e	¹¹⁷ u	¹³³ ù	¹⁴⁹ è	¹⁶⁵ ï	¹⁸¹ ↵	¹⁹⁷ ®	²¹³ ~
⁰³⁸ &	⁰⁵⁴ 6	⁰⁷⁰ F	⁰⁸⁶ V	¹⁰² f	¹¹⁸ v	¹³⁴ ú	¹⁵⁰ é	¹⁶⁶ Ñ	¹⁸² ð	¹⁹⁸ □	²¹⁴ ÷
⁰³⁹ ' °	⁰⁵⁵ 7	⁰⁷¹ G	⁰⁸⁷ W	¹⁰³ g	¹¹⁹ w	¹³⁵ Ô	¹⁵¹ ë	¹⁶⁷ ñ	¹⁸³ £	¹⁹⁹ ☐	²¹⁵ «
⁰⁴⁰ (⁰⁵⁶ 8	⁰⁷² H	⁰⁸⁸ X	¹⁰⁴ h	¹²⁰ x	¹³⁶ Ò	¹⁵² Ä	¹⁶⁸ Ñ	¹⁸⁴ →	²⁰⁰ μ	²¹⁶ »
⁰⁴¹)	⁰⁵⁷ 9	⁰⁷³ I	⁰⁸⁹ Y	¹⁰⁵ i	¹²¹ y	¹³⁷ Ó	¹⁵³ Å	¹⁶⁹ Œ	¹⁸⁵ ↓	²⁰¹ Ø	²¹⁷ †
⁰⁴² *	⁰⁵⁸ :	⁰⁷⁴ J	⁰⁹⁰ Z	¹⁰⁶ j	¹²² z	¹³⁸ Ô	¹⁵⁴ å	¹⁷⁰ 9	¹⁸⁶ ↑	²⁰² Ÿ	²¹⁸ \
⁰⁴³ +	⁰⁵⁹ ;	⁰⁷⁵ K	⁰⁹¹ [¹⁰⁷ k	¹²³ {	¹³⁹ Õ	¹⁵⁵ â	¹⁷¹ v	¹⁸⁷ ↓	²⁰³ Å	²¹⁹ X
⁰⁴⁴ ,	⁰⁶⁰ <	⁰⁷⁶ L	⁰⁹² \	¹⁰⁸ l	¹²⁴	¹⁴⁰ ò	¹⁵⁶ à	¹⁷² v	¹⁸⁸ ¶	²⁰⁴ €	²²⁰ ©
⁰⁴⁵ -	⁰⁶¹ =	⁰⁷⁷ M	⁰⁹³]	¹⁰⁹ m	¹²⁵ }	¹⁴¹ ó	¹⁵⁷ á	¹⁷³ w	¹⁸⁹ ½	²⁰⁵ ã	²²¹ ©
⁰⁴⁶ .	⁰⁶² >	⁰⁷⁸ N	⁰⁹⁴ ^	¹¹⁰ n	¹²⁶ →	¹⁴² ô	¹⁵⁸ ä	¹⁷⁴ w	¹⁹⁰ ½	²⁰⁶ Ö	²²² ©
⁰⁴⁷ /	⁰⁶³ ?	⁰⁷⁹ O	⁰⁹⁵ _	¹¹¹ o	¹²⁷ ←	¹⁴³ ȇ	¹⁵⁹ Å	¹⁷⁵ Æ	¹⁹¹ ¼	²⁰⁷ õ	²²³ ≡

Hebrew Keypad Letter Assignment

Key	Press key once	Press key twice	Press key three times
[1]	א	ב	ג
[2]	ד	ה	ו
[3]	ז	ח	ט
[4]	י	ך	ש
[5]	ל	ם	נ
[6]	ס	ן	ע
[7]	פ	ק	ר
[8]	שׁ	שׂ	שׂ
[9]	ת	ת	ת

Hebrew Special Characters Catalogue

032	048	064	080	096	112	160	176	192	208	224	240
	0	ן	פ	ץ	ר	ך	ל	י	כ	ע	ף
033	049	065	081	097	113	161	177	193	209	225	241
	!	א	ב	ג	ד	ה	ו	ז	ח	ט	י
034	050	066	082	098	114	162	178	194	210	226	242
	"	ב	ר	ב	ר	ל	ו	ל	י	כ	ש
035	051	067	083	099	115	163	179	195	211	227	243
	#	צ	ס	ס	ט	ט	ך	ך	שׁ	שׂ	שׂ
036	052	068	084	100	116	164	180	196	212	228	244
	φ	ד	ט	ד	ט	ה	ה	ב	ב	ב	ר
037	053	069	085	101	117	165	181	197	213	229	245
	%	ע	ו	ע	ו	י	י	א	א	א	ב
038	054	070	086	102	118	166	182	198	214	230	246
	&	פ	ו	פ	ו	ז	ז	א	א	א	ב
039	055	071	087	103	119	167	183	199	215	231	247
	'	ג	ו	ג	ו	ה	ה	ב	ב	ב	ר
040	056	072	088	104	120	168	184	200	216	232	248
	<	ח	ח	ח	ח	ג	ג	א	א	א	ב
041	057	073	089	105	121	169	185	201	217	233	249
	>	י	י	י	י	ד	ד	א	א	א	ב
042	058	074	090	106	122	170	186	202	218	234	250
	*	:	ז	ז	ז	ה	ה	א	א	א	ב
043	059	075	091	107	123	171	187	203	219	235	251
	+	ג	ו	ג	ו	ה	ה	א	א	א	ב
044	060	076	092	108	124	172	188	204	220	236	252
	,	<	ל	ל	ל	ז	ז	א	א	א	ב
045	061	077	093	109	125	173	189	205	221	237	253
	-	=	מ	מ	מ	ה	ה	א	א	א	ב
046	062	078	094	110	126	174	190	206	222	238	254
	.	>	נ	נ	נ	ה	ה	א	א	א	ב
047	063	079	095	111	127	175	191	207	223	239	255
	/	ד	ו	ד	ו	ה	ה	א	א	א	ב

Greek Keypad Letter Assignment

Key	Press key once	Press key twice	Press key three times
[1]	A	B	Γ
[2]	Δ	E	Z
[3]	H	Θ	I
[4]	K	Λ	M
[5]	N	Ξ	O
[6]	Π	P	Σ
[7]	T	Υ	Φ
[8]	X	Ψ	Ω

Greek Special Characters Catalogue

016	032	048	064	080	096	112	128	144	160	176	192	208	224	240
	±	0	α	β	γ	δ	ε	ζ	η	θ	ι	κ	λ	μ
017	033	049	065	081	097	113	129	145	161	177	193	209	225	241
	≡	1	α	β	γ	δ	ε	ζ	η	θ	ι	κ	λ	μ
018	034	050	066	082	098	114	130	146	162	178	194	210	226	242
	∂	"	β	ρ	β	ρ	λ	ו	ל	ו	ל	י	כ	ש
019	035	051	067	083	099	115	131	147	163	179	195	211	227	243
	∫	#	צ	ס	ס	ט	ט	ך	ך	שׁ	שׂ	שׂ	שׂ	שׂ
020	036	052	068	084	100	116	132	148	164	180	196	212	228	244
	∫	\$	ד	ט	ד	ט	ה	ה	ב	ב	ב	ר	ר	ר
021	037	053	069	085	101	117	133	149	165	181	197	213	229	245
	∫	%	ע	ו	ע	ו	י	י	א	א	א	ב	ב	ב
022	038	054	070	086	102	118	134	150	166	182	198	214	230	246
	∫	&	פ	ו	פ	ו	ז	ז	א	א	א	ב	ב	ב
023	039	055	071	087	103	119	135	151	167	183	199	215	231	247
	∫	'	ג	ו	ג	ו	ה	ה	ב	ב	ב	ר	ר	ר
024	040	056	072	088	104	120	136	152	168	184	200	216	232	248
	∫	<	ח	ח	ח	ח	ג	ג	א	א	א	ב	ב	ב
025	041	057	073	089	105	121	137	153	169	185	201	217	233	249
	∫	>	י	י	י	י	ד	ד	א	א	א	ב	ב	ב
026	042	058	074	090	106	122	138	154	170	186	202	218	234	250
	∫	*	:	ז	ז	ז	ה	ה	א	א	א	ב	ב	ב
027	043	059	075	091	107	123	139	155	171	187	203	219	235	251
	∫	+	;	ק	ל	ק	ל	ז	ז	א	א	א	ב	ב
028	044	060	076	092	108	124	140	156	172	188	204	220	236	252
	=	<	ל	ל	ל	ז	ז	א	א	א	ב	ב	ב	ב
029	045	061	077	093	109	125	141	157	173	189	205	221	237	253
	∫	-	=	מ	מ	מ	ה	ה	א	א	א	ב	ב	ב
030	046	062	078	094	110	126	142	158	174	190	206	222	238	254
	∫	.	>	נ	נ	נ	ה	ה	א	א	א	ב	ב	ב
031	047	063	079	095	111	127	143	159	175	191	207	223	239	255
	∫	/	ד	ו	ד	ו	ה	ה	א	א	א	ב	ב	ב

Russian Keypad Letter Assignment

Key	Press key once	Press key twice	Press key three times	Press key four times
[1]	А	Б	В	Г
[2]	Д	Е	Ё	Ж
[3]	З	И	Й	К
[4]	Л	М	Н	О
[5]	П	Р	С	Т
[6]	У	Ф	Х	Ц
[7]	Ч	Ш	Щ	Ъ
[8]	Ы	Ь	Э	Ю
[9]	Я			

Russian Special Characters Catalogue

032	048	064	080	096	112	128	144	160	176	192	208	224	240
	0	Ð	Р	`	р			Б	Ю	Ч		Д	¼
033	049	065	081	097	113	129	145	161	177	193	209	225	241
	!	1	А	Q	а	q		Г	Я	Ш		Ц	⅓
034	050	066	082	098	114	130	146	162	178	194	210	226	242
	"	2	В	R	в	г		Ё	Б	Ъ		Щ	½
035	051	067	083	099	115	131	147	163	179	195	211	227	243
	#	3	С	S	с	с		Ж	В	Ы	!!	Л	
036	052	068	084	100	116	132	148	164	180	196	212	228	244
	\$	4	D	T	d	t		З	Г	Ь		Ф	
037	053	069	085	101	117	133	149	165	181	197	213	229	245
	%	5	E	U	e	u		И	ё	Э		Ц	
038	054	070	086	102	118	134	150	166	182	198	214	230	246
	&	6	F	V	f	v		Й	Ж	Ю		Щ	
039	055	071	087	103	119	135	151	167	183	199	215	231	247
	'	7	G	W	g	w		Л	З	Я		'	
040	056	072	088	104	120	136	152	168	184	200	216	232	248
	(8	H	X	h	x		П	И	«		••	
041	057	073	089	105	121	137	153	169	185	201	217	233	249
)	9	I	Y	i	y		У	Й	»	↑	~	
042	058	074	090	106	122	138	154	170	186	202	218	234	250
	*	:	J	Z	j	z		Ф	К	"	↓	é	
043	059	075	091	107	123	139	155	171	187	203	219	235	251
	+	;	K	[k	10		Ч	Л	"		ç	
044	060	076	092	108	124	140	156	172	188	204	220	236	252
	,	<	L	ç	l	12		Ш	М			ij	
045	061	077	093	109	125	141	157	173	189	205	221	237	253
	-	=	M]	m	15		Ъ	И	ç		§	
046	062	078	094	110	126	142	158	174	190	206	222	238	254
	.	>	N	^	n	←		Ы	П	f		¶	
047	063	079	095	111	127	143	159	175	191	207	223	239	255
	/	?	O	_	o			Э	Т	£	■	○	

Zone Labels

Section	Zone	Label	Section	Zone	Label
[181]	1	_____	[197]	17	_____
[182]	2	_____	[198]	18	_____
[183]	3	_____	[199]	19	_____
[184]	4	_____	[200]	20	_____
[185]	5	_____	[201]	21	_____
[186]	6	_____	[202]	22	_____
[187]	7	_____	[203]	23	_____
[188]	8	_____	[204]	24	_____
[189]	9	_____	[205]	25	_____
[190]	10	_____	[206]	26	_____
[191]	11	_____	[207]	27	_____
[192]	12	_____	[208]	28	_____
[193]	13	_____	[209]	29	_____
[194]	14	_____	[210]	30	_____
[195]	15	_____	[211]	31	_____
[196]	16	_____	[212]	32	_____

PGM Labels

Section	PGM	Label	Section	PGM	Label
[341]	1	_____	[349]	9	_____
[342]	2	_____	[350]	10	_____
[343]	3	_____	[351]	11	_____
[344]	4	_____	[352]	12	_____
[345]	5	_____	[353]	13	_____
[346]	6	_____	[354]	14	_____
[347]	7	_____	[355]	15	_____
[348]	8	_____	[356]	16	_____

User Labels

Section	User	Label	Section	User	Label
[511]	1	_____	[527]	17	_____
[512]	2	_____	[528]	18	_____
[513]	3	_____	[529]	19	_____
[514]	4	_____	[530]	20	_____
[515]	5	_____	[531]	21	_____
[516]	6	_____	[532]	22	_____
[517]	7	_____	[533]	23	_____
[518]	8	_____	[534]	24	_____
[519]	9	_____	[535]	25	_____
[520]	10	_____	[536]	26	_____
[521]	11	_____	[537]	27	_____
[522]	12	_____	[538]	28	_____
[523]	13	_____	[539]	29	_____
[524]	14	_____	[540]	30	_____
[525]	15	_____	[541]	31	_____
[526]	16	_____	[542]	32	_____

Partition Labels

Section	Part.	Label	Section	Part.	Label
[771]	1	_____	[772]	2	_____

Wireless Repeater Labels

Section	Rep.	Label	Section	Rep.	Label
[568]	1	_____	[569]	2	_____

Wireless Keypad Labels

Section	Key.	Label	Section	Key.	Label
[599]	1	_____	[603]	5	_____
[600]	2	_____	[604]	6	_____
[601]	3	_____	[605]	7	_____
[602]	4	_____	[606]	8	_____

Bus Modules Labels

Section	Bus	Label	Section	Bus	Label
[781]	1	_____	[789]	9	_____
[782]	2	_____	[790]	10	_____
[783]	3	_____	[791]	11	_____
[784]	4	_____	[532]	12	_____
[785]	5	_____	[533]	13	_____
[786]	6	_____	[534]	14	_____
[787]	7	_____	[795]	15	_____
[788]	8	_____			

System Programming

[700]	General System Options	Bold = Default setting	
Option		OFF	ON
[1]	Partitioning	<input type="checkbox"/> Disabled	<input type="checkbox"/> Enabled
[2]	Battery charging (350mA or 700mA)	<input type="checkbox"/> 350mA	<input type="checkbox"/> 700mA
[3]	Audible trouble warning (except AC failure)	<input type="checkbox"/> Disabled	<input type="checkbox"/> Enabled
[4]	Audible trouble warning on AC failure	<input type="checkbox"/> Disabled	<input type="checkbox"/> Enabled
[5]	RF jamming supervision	<input type="checkbox"/> Disabled	<input type="checkbox"/> Enabled
[6]	Exit delay termination	<input type="checkbox"/> Disabled	<input type="checkbox"/> Enabled
[7]	Tamper supervision on the bus module	<input type="checkbox"/> Disabled	<input type="checkbox"/> Enabled
[8]	N/A	N/A	N/A

[701]	General System Options	Bold = Default setting	
Option		OFF	ON
[1]	Access code length	<input type="checkbox"/> 6 digits	<input type="checkbox"/> 4 digits
[2]	Lock master code	<input type="checkbox"/> Disabled	<input type="checkbox"/> Enabled
[3]	Confidential mode	<input type="checkbox"/> Disabled	<input type="checkbox"/> Enabled
[4]	To exit confidential mode	<input type="checkbox"/> Enter a code	<input type="checkbox"/> Press a key
[5]	Confidential mode timer	<input type="checkbox"/> 2 minutes	<input type="checkbox"/> 5 seconds
[6]	MG-REM2 version number	<input type="checkbox"/> MG-REM2 V2.00	<input type="checkbox"/> MG-REM2 V2.01 or higher
[7]	Display entry delay on LCD keypad (MG32LCD)	<input type="checkbox"/> Disabled	<input type="checkbox"/> Enabled
[8]	Display exit delay on LCD keypad (MG32LCD)	<input type="checkbox"/> Disabled	<input type="checkbox"/> Enabled

[702]	Panic Options	Bold = Default setting	
Option		OFF	ON
[1]	Panic 1	<input type="checkbox"/> Disabled	<input type="checkbox"/> Enabled
[2]	Panic 2	<input type="checkbox"/> Disabled	<input type="checkbox"/> Enabled
[3]	Panic 3	<input type="checkbox"/> Disabled	<input type="checkbox"/> Enabled
[4]	Panic 1: Silent or audible alarm	<input type="checkbox"/> Silent	<input type="checkbox"/> Audible
[5]	Panic 2: Silent or audible alarm	<input type="checkbox"/> Silent	<input type="checkbox"/> Audible
[6]	Panic 3: Silent or audible alarm	<input type="checkbox"/> Silent	<input type="checkbox"/> Audible
[7] & [8]	N/A	N/A	N/A

[703]	Arming/Disarming Options 1	Bold = Default setting	
Option		OFF	ON
[1]	One-touch regular arming	<input type="checkbox"/> Disabled	<input type="checkbox"/> Enabled
[2]	One-touch stay arming	<input type="checkbox"/> Disabled	<input type="checkbox"/> Enabled
[3]	One-touch sleep arming	<input type="checkbox"/> Disabled	<input type="checkbox"/> Enabled
[4]	One-touch bypass programming	<input type="checkbox"/> Disabled	<input type="checkbox"/> Enabled
[5]	Restrict arming on battery failure	<input type="checkbox"/> Disabled	<input type="checkbox"/> Enabled
[6]	Restrict arming on tamper failure (Zone + Bus Module + Wireless PGM)	<input type="checkbox"/> Disabled	<input type="checkbox"/> Enabled
[7]	Restrict arming on wireless supervision trouble (Zone + Bus Module + Wireless PGM)	<input type="checkbox"/> Disabled	<input type="checkbox"/> Enabled
[8]	Calling the VDMP3	<input type="checkbox"/> Disabled	<input type="checkbox"/> Enabled

[704] Arming/Disarming Options 2 Bold = Default setting

Option	OFF	ON
[1] Regular arming switches to force arming	<input type="checkbox"/> Disabled	<input type="checkbox"/> Enabled
[2] Stay arming switches to stay force arming	<input type="checkbox"/> Disabled	<input type="checkbox"/> Enabled
[3] Sleep arming switches to sleep force arming	<input type="checkbox"/> Disabled	<input type="checkbox"/> Enabled
[4] Bell squawk when arm/disarm with remote	<input type="checkbox"/> Disabled	<input type="checkbox"/> Enabled
[5] Bell squawk when arm/disarm with a keypad	<input type="checkbox"/> Disabled	<input type="checkbox"/> Enabled
[6] Beep on exit delay	<input type="checkbox"/> Disabled	<input type="checkbox"/> Enabled
[7] No exit delay beeps and no bell squawk when stay/sleep arm	<input type="checkbox"/> Disabled	<input type="checkbox"/> Enabled
[8] No exit delay when arm with a remote	<input type="checkbox"/> Disabled	<input type="checkbox"/> Enabled

[705] General Zone Options 1 Bold = Default setting

Option	OFF	ON
[1] ATZ zone doubling	<input type="checkbox"/> Disabled	<input type="checkbox"/> Enabled
[2] ATZ wiring options	<input type="checkbox"/> Series	<input type="checkbox"/> Parallel
[3] & [4] Tamper Recognition		

[3]	[4]	RF Zone/Hardwired Zone Tamper Recognition Options	Keypad Bus /Module Tamper Recognition Options*
OFF	OFF	Disabled	Disabled
OFF	ON	TROUBLE ONLY	TROUBLE ONLY
ON	OFF	When disarmed: TROUBLE ONLY When armed: Follow zone's alarm type	TROUBLE ONLY
ON	ON	When disarmed: AUDIBLE ALARM When armed: Follow zone's alarm type	AUDIBLE ALARM

* Tamper recognition of keypad / bus module only if section [700] option [7] is enabled.

[5] Generate tamper on bypassed zone No **Yes**

[6] & [7] Supervision Options

[6]	[7]	RF Zone Supervision Options	Keypad Bus / Module Supervision Options
OFF	OFF	Disabled	Disabled
OFF	ON	TROUBLE ONLY	TROUBLE ONLY
ON	OFF	When disarmed: TROUBLE ONLY When armed: Follow zone's alarm type	TROUBLE ONLY
ON	ON	When disarmed: AUDIBLE ALARM When armed: Follow zone's alarm type	AUDIBLE ALARM

[8] Generate supervision on bypassed zone No **Yes**

[706] General Zone Options 2 Bold = Default setting

Option	OFF	ON
[1] Check-in supervision time	<input type="checkbox"/> 24 hours	<input type="checkbox"/> 80 minutes
[2] EOL resistors	<input type="checkbox"/> Disabled	<input type="checkbox"/> Enabled
[3] Zone Input 1 becomes a 2-wire smoke input (except SP5500)	<input type="checkbox"/> Disabled	<input type="checkbox"/> Enabled
[4] ZX8 ID A (Panel + 1) Input 1	<input type="checkbox"/> Zone input	<input type="checkbox"/> Tamper input
[5] ZX8 ID B (Panel + 9) Input 1	<input type="checkbox"/> Zone input	<input type="checkbox"/> Tamper input
[6] ZX8 ID C (Panel + 17) Input 1	<input type="checkbox"/> Zone input	<input type="checkbox"/> Tamper input
[7] to [8] N/A	N/A	N/A

System Timers

Section	Data	Description
[710]	___/___/___	(000 to 255) seconds Entry delay 1 (default 045)
[711]	___/___/___	(000 to 255) seconds Entry delay 2 (default 045)
[712]	___/___/___	(000 to 255) Auto zone shutdown counter (Default 005)
[713]	___/___/___	(000 to 255) seconds Intellizone delay (default 048)
[714]	___/___/___	(000 to 255) minutes Recycle alarm delay (default 000)
[715]	___/___/___	(000 to 255) Recycle alarm counter (default 000)
[716]	___/___/___	(000 to 255) minutes Keypad lockout delay (default 000)
[717]	___/___/___	(000 to 255) attempt before locking Keypad lockout counter (default 000)
[718]	___/___/___	(000 to 255) seconds Remote panic disarm lock delay (default 000)
[719]	___/___/___	(000 to 255) days Closing delinquency delay (default 000)
[720]	___/___/___	(000 to 255) seconds For StayD: Flex-Instant delay (default 015)
[721]	___/___/___	(000 to 255) seconds For StayD: Re-arm delay (default 005)



Refer to the **Installer Quick Menu** on page 3 for alternate entry/exit and bell cut-off timer programming.

Daylight Savings Programming

[730]	General Zone Options 3	OFF	ON
	Option		
[1]	Daylight savings	<input type="checkbox"/> Disabled	<input type="checkbox"/> Enabled
[2]	N/A	N/A	N/A

Section	Data	Description
[731]	(00 to 99)	Country code

Country Code List (Default = bold)	
00 = US, Canada, Mexico, St.Johns, Bahamas, Turks and Caicos	09 = Lord Howe Island- Tasmania
01 = Cuba	10 = New Zealand, Chatham
02 = Brazil	11 = Tonga
03 = Chile	12 = Iraq and Syria
04 = Falklands	13 = Israel
05 = Paraguay	14 = Lebanon, Kirgizstan
06 = European Union, UK, and Greenland	15 = Palestine
07 = Russia and most states of the former USSR	16 = Egypt
08 = Australia- South Australia, Victoria, Australian Capital Territory, New South Wales	17 = Namibia
	18 = USA, Canada (New Daylight Saving Time for 2007)
	19 = New Zealand (New Daylight Saving Time for 2007)

Customized Daylight Saving Programming

In addition to using the default Daylight Saving Time (DST) settings in section [731], you can also set a customized DST. Set section [732] for the DST starting period and [733] for the DST ending period. Both sections recognize 5 different entries of 2 digits each. All entries must be assigned in this respective order:

Months	01 to 12	01 = January	*If the day is set at 00, the DST will automatically change on the programmed country code listed above.
Date	01 to 31	01 = First day of the month	
Day	00 to 07	00 = Default*, 01 = Sunday	
Hours	00 to 23	00 = Midnight	
Minutes	00 to 59	00 = 60 minutes or 1 hour	

Section	Data	Description
[732]	___/___/___/___/___/___/___/___/___/___	Daylight Savings Time Starting Period
[733]	___/___/___/___/___/___/___/___/___/___	Daylight Savings Time Ending Period

Partition Programming

[741]	Partition 1 Options		Bold = Default setting												
	Option		OFF ON												
[1]	Auto-arm on time	<input type="checkbox"/> Disabled	<input type="checkbox"/> Enabled												
[2]	Auto-arm on no movement	<input type="checkbox"/> Disabled	<input type="checkbox"/> Enabled												
	Auto-arm arming mode	<input type="checkbox"/> See Table	<input type="checkbox"/> See Table												
[3]& [4]	<table border="1"> <thead> <tr> <th>[3]</th> <th>[4]</th> <th></th> </tr> </thead> <tbody> <tr> <td>OFF</td> <td>OFF</td> <td>Regular</td> </tr> <tr> <td>OFF</td> <td>ON</td> <td>Sleep</td> </tr> <tr> <td>ON</td> <td>OFF</td> <td>Stay</td> </tr> </tbody> </table>	[3]	[4]		OFF	OFF	Regular	OFF	ON	Sleep	ON	OFF	Stay		
[3]	[4]														
OFF	OFF	Regular													
OFF	ON	Sleep													
ON	OFF	Stay													
[5]	Switch to stay arming if no zone entry delay is opened	<input type="checkbox"/> Disabled	<input type="checkbox"/> Enabled												
[6]	Follow zones become entry delay 2 when delay zone is bypassed	<input type="checkbox"/> Disabled	<input type="checkbox"/> Enabled												
[7]& [8]	N/A	N/A	N/A												

[742]	Partition 2 Options		Bold = Default setting												
	Option		OFF ON												
[1]	Auto-arm on time	<input type="checkbox"/> Disabled	<input type="checkbox"/> Enabled												
[2]	Auto-arm on no movement	<input type="checkbox"/> Disabled	<input type="checkbox"/> Enabled												
	Auto-arm arming mode	<input type="checkbox"/> See Table	<input type="checkbox"/> See Table												
[3]& [4]	<table border="1"> <thead> <tr> <th>[3]</th> <th>[4]</th> <th></th> </tr> </thead> <tbody> <tr> <td>OFF</td> <td>OFF</td> <td>Regular</td> </tr> <tr> <td>OFF</td> <td>ON</td> <td>Sleep</td> </tr> <tr> <td>ON</td> <td>OFF</td> <td>Stay</td> </tr> </tbody> </table>	[3]	[4]		OFF	OFF	Regular	OFF	ON	Sleep	ON	OFF	Stay		
[3]	[4]														
OFF	OFF	Regular													
OFF	ON	Sleep													
ON	OFF	Stay													
[5]	Switch to stay arming if no entry delay is opened	<input type="checkbox"/> Disabled	<input type="checkbox"/> Enabled												
[6]	Follow zones become entry delay 2 when delay zone is bypassed	<input type="checkbox"/> Disabled	<input type="checkbox"/> Enabled												
[7]& [8]	N/A	N/A	N/A												

Partition Timers

Section	Data	Description
[745]	___/___/___	(000 to 255) seconds Partition 1 exit delay (default 060)
[746]	___/___/___	(000 to 255) seconds Partition 2 exit delay (default 060)
[747]	___/___/___	(000 to 255) minutes Partition 1 bell cut-off (default 004)
[748]	___/___/___	(000 to 255) minutes Partition 2 bell cut-off (default 004)
[749]	___/___/___	(000 to 255) x 15 minutes Partition 1 no movement (default 000)
[750]	___/___/___	(000 to 255) x 15 minutes Partition 2 no movement (default 000)

Section	Data	Description
[761]	___/___:___/___	HH: MM Auto-arm on time Partition 1 (default 00:00)
[762]	___/___:___/___	HH: MM Auto-arm on time Partition 2 (default 00:00)

Communication Programming

[800] Dialer Options Bold = Default setting

Option **OFF** **ON**
 See Table See Table

Telephone Line Monitoring (TLM) Options		
[1]	[2]	
OFF	OFF	Disabled
OFF	ON	When disarmed: Trouble only When armed: Trouble only
ON	OFF	When disarmed: Trouble only When armed: Audible alarm
ON	ON	Silent alarms become Audible alarm

[1] & [2] **Disabled** Enabled
 [3] Switch to pulse on 5th attempt **Disabled** Enabled
 [4] Alternate dial Disabled Enabled
 [5] Force dial (must be enabled to comply with TBR-21) Disabled **Enabled**
 [6] DTMF dialing Disabled **Enabled**
 [7] Pulse ratio 1:2 **1:1.5**
 [8] Disable reporting **Dialer activated** No dialer

[801] Dialer Options Bold = Default setting

Option **OFF** **ON**
 [1] Report system disarming Always **After alarm**
 [2] Report zone restore **Bell cutoff** Zone closure

[3]	[4]	Auto-Test Report Transmission Options
OFF	OFF	Transmit the test report code every time the days programmed in section [840] have elapsed at the time programmed in section [850] (default).
OFF	ON	When disarmed: Transmit test report code every time the time programmed in section [852] has elapsed. When armed: Transmit test report code every time the time programmed in section [851] has elapsed.
ON	OFF	The control panel will transmit the test report code every hour on the minute value programmed in section [850] (the last two digits). Note that the first two digits of section [850] will be ignored. <i>E.g. If 10:25 was programmed into section [850], the test report code would be transmitted at the 25th minute of every hour, i.e. 11:25, 12:25, etc.</i>
ON	ON	The test report code will be transmitted when any of the conditions of the second and third options listed above (options [3] = OFF and [4] = ON / options [3] = ON and [4] = OFF) are met.

[5] to [8] N/A N/A N/A

[802] Event Call Direction Options 1 Bold = Default setting

Option **OFF** **ON**
 [1] Call tel. #1 for arm/disarm reporting codes Disabled **Enabled**
 [2] Call tel. #2 for arm/disarm reporting codes Disabled **Enabled**
 [3] Call pager for arm/disarm reporting codes **Disabled** Enabled
 [4] N/A N/A N/A
 [5] Call tel. #1 for alarm/restore reporting codes Disabled **Enabled**
 [6] Call tel. #2 for alarm/restore reporting codes Disabled **Enabled**
 [7] Call pager for alarm/restore reporting codes Disabled **Enabled**
 [8] N/A N/A N/A

[803] Event Call Direction Options 2 **Bold = Default setting**

Option		OFF	ON
[1]	Call tel. #1 for tamper/restore reporting codes	<input type="checkbox"/> Disabled	<input type="checkbox"/> Enabled
[2]	Call tel. #2 for tamper/restore reporting codes	<input type="checkbox"/> Disabled	<input type="checkbox"/> Enabled
[3]	Call pager for tamper/restore reporting codes	<input type="checkbox"/> Disabled	<input type="checkbox"/> Enabled
[4]	N/A	N/A	N/A
[5]	Call tel. #1 for trouble/restore reporting codes	<input type="checkbox"/> Disabled	<input type="checkbox"/> Enabled
[6]	Call tel. #2 for trouble/restore reporting codes	<input type="checkbox"/> Disabled	<input type="checkbox"/> Enabled
[7]	Call pager for trouble/restore reporting codes	<input type="checkbox"/> Disabled	<input type="checkbox"/> Enabled
[8]	N/A	N/A	N/A

[804] Event Call Direction Options 3 **Bold = Default setting**

Option		OFF	ON
[1]	Call tel. #1 for special reporting codes	<input type="checkbox"/> Disabled	<input type="checkbox"/> Enabled
[2]	Call tel. #2 for special reporting codes	<input type="checkbox"/> Disabled	<input type="checkbox"/> Enabled
[3]	Call pager for special reporting codes	<input type="checkbox"/> Disabled	<input type="checkbox"/> Enabled
[4]	N/A	N/A	N/A
[5]	Call personal tel. # on zone alarm (burglary/fire)	<input type="checkbox"/> Disabled	<input type="checkbox"/> Enabled
[6]	Call personal tel. # on panic alarms	<input type="checkbox"/> Disabled	<input type="checkbox"/> Enabled
[7]	Call personal tel. # on parademic alarm	<input type="checkbox"/> Disabled	<input type="checkbox"/> Enabled
[8]	N/A	N/A	N/A

Communication Settings

Section	Data	Description
[810]	__ / __ TEL1 TEL2	Reporting format 0 = Ademco Slow 1 = Silent Knight Fast 2 = Sescoa 3 = Ademco Express 4 = Ademco Contact ID (default) 5 = SIA
[811]	__ / __ / __ / __	Partition 1 Account number
[812]	__ / __ / __ / __	Partition 2 Account number

- [815] _____
MONITORING STATION TELEPHONE NUMBER 1
- [816] _____
MONITORING STATION TELEPHONE NUMBER 2
- [817] _____
BACK UP TELEPHONE NUMBER
- [818] _____
PAGER TELEPHONE NUMBER
- [819] _____
NUMERIC MESSAGE SENT WITH PAGER REPORTING

Special Keys for Telephone Numbers	
Press	Action or Value
[OFF]	*
[BYP]	#
[MEM]	switch from pulse to tone dialling or vice versa
[TBL]	4-second pause
[SLEEP]	deletes current digit
[␣]	inserts blank space

 Refer to the **Installer Quick Menu** on page 3 and the **Master Quick Menu** in the User Guide for programming telephone numbers.

 To erase a phone number/numeric message, press the **[SLEEP]** key for each digit in the respective section.

Communication Timers

Section	Data	Description
[830]	___/___/___ (000 to 255) x 2 sec.	TLM fail delay (default 016)
[831]	___/___/___ (000 to 255) max 32	Maximum dialing attempts monitoring station (default 008)
[832]	___/___/___ (000 to 255) sec. (max 127)	Delay between dialing attempts* (default 020)
[833]	___/___/___ (000 to 255) seconds	Delay alarm transmission (default 000)
[834]	___/___/___ (000 to 255) sec. (max 127)	Pager reporting delay (default 020)
[835]	___/___/___ (000 to 255) max 10	Pager reporting message repetition (default 003)
[836]	___/___/___ (000 to 255) sec. (max 127)	Personal reporting delay* (default 005)
[837]	___/___/___ (000 to 255) max 10	Personal reporting message repetition* (default 003)
[838]	___/___/___ (000 to 255) seconds	Recent closing delay (default 000)
[839]	___/___/___ (000 to 255) minutes	Power failure report delay (default 015)
[840]	___/___/___ (000 to 255) days	Auto test report (default 000)
[841]	___/___/___ (000 to 255) max 32	Maximum voice dialing attempts - VDMP3 (default 008)

Section	Data	Description
[850]	___/___/___/___ HH: MM	Auto test report time of day (default 00:00)
[851]	___/___/___ (000 to 255) x 1 minute	Armed report delay (default 005)
[852]	___/___/___ (000 to 255) x 1 minute	Disarmed report delay (default 060)

Special Arming Report Codes (Default = FF)

Section	Data	Description	Section	Data	Description
[860]	___/___	Auto-arming	[861]	___/___	Quick arming
	___/___	Late to close		___/___	Arming via PC
	___/___	No movement		___/___	Arming with Keyswitch
	___/___	Partial arming		___/___	N/A

Special Disarming Report Codes (Default = FF)

Section	Data	Description
[862]	___/___	Cancel auto-arm
	___/___	Disarming via PC
	___/___	Cancel alarm with user or WinLoad
	___/___	Cancel paramedic

Special Alarm Report Codes (Default = FF)

Section	Data	Description	Section	Data	Description
[863]	___/___	Emergency panic	[864]	___/___	Zone shutdown
	___/___	Auxiliary panic		___/___	Duress
	___/___	Fire panic		___/___	Keypad lockout
	___/___	Recent closing		___/___	Paramedic alarm



Refer to *Decimal and Hexadecimal Values* on page 50.

System Trouble Report Codes (Default FF)

Section	Data	Description	Section	Data	Description
[865]	___/___	N/A	[868]	___/___	Module power fail
	___/___	AC failure		___/___	Module low/no battery
	___/___	Battery failure		___/___	Wireless zone low battery
	___/___	Auxiliary supply		___/___	Wireless zone supervision lost
[866]	___/___	Bell output overload	[869]	___/___	Wireless module supervision lost
	___/___	Bell output disconnect		___/___	Wireless module tamper
	___/___	Timer loss		___/___	N/A
	___/___	Fire loop trouble		___/___	Wireless module low battery
[867]	___/___	Fail to communicate			
	___/___	RF interference			
	___/___	Module lost			
	___/___	Module tamper			

System Trouble Restore Codes (Default FF)

Section	Data	Description	Section	Data	Description
[870]	___/___	TLM	[873]	___/___	Module power fail
	___/___	AC failure		___/___	Module low/no battery
	___/___	Battery failure		___/___	Wireless zone low battery
	___/___	Auxiliary supply		___/___	Wireless zone supervision lost
[871]	___/___	Bell output overload	[874]	___/___	Wireless module supervision lost
	___/___	Bell output disconnect		___/___	Wireless module tamper
	___/___	Timer loss		___/___	N/A
	___/___	Fire loop trouble		___/___	N/A
[872]	___/___	Fail to communicate			
	___/___	RF interference			
	___/___	Module lost			
	___/___	Module tamper			

System Special Report Code (Default = FF)

Section	Data	Description	Section	Data	Description
[875]	___/___	Cold start	[876]	___/___	Installer in
	___/___	Test report		___/___	Installer out
	___/___	N/A		___/___	Closing Delinquency
	___/___	Software out		___/___	N/A
[878]	___/___	Disarm with Keyswitch			
	___/___	Disarm with Keyswitch after alarm			
	___/___	Alarm cancelled with Keyswitch			
	___/___	N/A			



Refer to *Decimal and Hexadecimal Values* on page 50.

Clear Reporting Codes

[966]	Clear Reporting Codes	Bold = Default setting	
Option		OFF	ON
[1]	Clear zone reporting codes*	<input type="checkbox"/> Disabled	<input type="checkbox"/> Enabled
[2]	Clear user reporting codes*	<input type="checkbox"/> Disabled	<input type="checkbox"/> Enabled
[3]	Clear arm/disarm/alarm reporting codes*	<input type="checkbox"/> Disabled	<input type="checkbox"/> Enabled
[4]	Clear trouble reporting codes*	<input type="checkbox"/> Disabled	<input type="checkbox"/> Enabled

* Enable all options you want to clear. The respective sets of reporting codes will be cleared after exiting the section.

Reset Reporting Codes

[967]	Reset Reporting Codes	Bold = Default setting	
Option		OFF	ON
[1]	Reset zone reporting codes to default**	<input type="checkbox"/> Disabled	<input type="checkbox"/> Enabled
[2]	Reset user reporting codes to default**	<input type="checkbox"/> Disabled	<input type="checkbox"/> Enabled
[3]	Reset arm/disarm/alarm reporting codes to default**	<input type="checkbox"/> Disabled	<input type="checkbox"/> Enabled
[4]	Reset trouble reporting codes to default**	<input type="checkbox"/> Disabled	<input type="checkbox"/> Enabled

** Enable all options you want to reset to default. The respective sets of reporting codes will be reset to default after exiting the section.

Appendix 1: Ademco Contact ID Report Codes

CID#	Reporting Code	Programming Value
Medical Alarms - 100		
100	Medical alarm	01
101	Pendant transmitter	02
102	Fail to report in	03
Fire Alarms - 110		
110	Fire alarm	04
111	Smoke	05
112	Combustion	06
113	Water flow	07
114	Heat	08
115	Pull station	09
116	Duct	0A
117	Flame	0B
118	Near alarm	0C
Panic Alarms - 120		
120	Panic Alarm	0D
121	Duress	0E
122	Silent	0F
123	Audible	10
124	Duress - Access grated	11
125	Duress - Egress granted	12
Burglar Alarms - 130		
130	Burglary	13
131	Perimeter	14
132	Interior	15
133	24-hour	16
134	Entry/Exit	17
135	Day/Night	18
136	Outdoor	19
137	Tamper	1A
138	Near alarm	1B
139	Intrusion verified	1C
General Alarms - 140		
140	General alarm	1D
141	Polling loop open	1E
142	Polling loop short	1F
143	Expansion module failure	20
144	Sensor tamper	21
145	Expansion module tamper	22
146	Silent burglary	23
147	Sensor supervision failure	24
24-hour Non-burglary - 150 and 160		
150	24-hour non-burglary	25

CID#	Reporting Code	Programming Value
151	Gas detected	26
152	Refrigeration	27
153	Loss of heat	28
154	Water leakage	29
155	Foil break	2A
156	Day trouble	2B
157	Low bottled gas level	2C
158	High temperature	2D
159	Low temperature	2E
161	Loss of air flow	2F
162	Carbon monoxide detected	30
163	Tank level	31
Fire Supervisory - 200 and 210		
200	Fire supervisory	32
201	Low water pressure	33
202	Low CO ₂	34
203	Gate valve sensor	35
204	Low water level	36
205	Pump activated	37
206	Pump failure	38
System Troubles - 300 and 310		
300	System trouble	39
301	AC loss	3A
302	Low system battery	3B
303	RAM checksum bad	3C
304	ROM checksum	3D
305	System reset	3E
306	Panel program changed	3F
307	Self-test failure	40
308	System shutdown	41
309	Battery test failure	42
310	Ground fault	43
311	Battery missing/dead	44
312	Power supply over current limit	45
313	Engineer reset	46
Sounder/Relay Troubles - 320		
320	Sounder/relay	47
321	Bell 1	48
322	Bell 2	49
323	Alarm relay	4A
324	Trouble relay	4B
325	Reversing relay	4C
326	Notification appliance chk. #3	4D

CID#	Reporting Code	Programming Value
327	Notification appliance chk. #4	4E
System Peripheral Troubles - 330 and 340		
330	System peripheral	4F
331	Polling loop open	50
332	Polling loop short	51
333	Expansion module failure	52
334	Repeater failure	53
335	Local printer paper out	54
336	Local printer failure	55
337	Exp. module DC loss	56
338	Exp. module low battery	57
339	Exp. module reset	58
341	Exp. module tamper	59
342	Exp. module AC loss	5A
343	Exp. module self-test fail	5B
344	RF receiver jam detect	5C
Communication Troubles - 350 and 360		
350	Communication	5D
351	Telco 1 fault	5E
352	Telco 2 fault	5F
353	Long range radio	60
354	Fail to communicate	61
355	Loss of radio supervision	62
356	Loss of central polling	63
357	Long range radio VSWR prob.	64
Protection Loop Troubles - 370		
370	Protection loop	65
371	Protection loop open	66
372	Protection loop short	67
373	Fire trouble	68
374	Exit error alarm	69
375	Panic zone trouble	6A
376	Hold-up zone trouble	6B
377	Swinger trouble	6C
378	Cross-zone trouble	6D
Sensor Troubles - 380 and 390		
380	Sensor trouble	6E
381	Loss of supervision - RF	6F
382	Loss of supervision - RPM	70
383	Sensor tamper	71
384	RF transmitter low battery	72
385	Smoke detector Hi sensitivity	73
386	Smoke detector Low sensitivity	74

CID#	Reporting Code	Programming Value
387	Intrusion detector Hi sensitivity	75
388	Intrusion detector Low sensitivity	76
389	Sensor self-test failure	77
391	Sensor watch trouble	78
392	Drift compensation error	79
393	Maintenance alert	7A
Open/Close - 400		
400	Open/Close	7B
401	Open/Close by user	7C
402	Group open/close	7D
403	Automatic open/close	7E
406	Cancel	7F
407	Remote arm/disarm	80
408	Quick arm	81
409	Keyswitch open/close	82
Remote Access - 410		
411	Call back request made	83
412	Success - download access	84
413	Unsuccessful access	85
414	System shutdown	86
415	Dialer shutdown	87
416	Successful upload	88
Access Control - 420 and 430		
421	Access denied	89
422	Access report by user	8A
423	Forced access	8B
424	Egress denied	8C
425	Egress granted	8D
426	Access door propped open	8E
427	Access point door status monitor trouble	8F
428	Access point request to exit	90
429	Access program mode entry	91
430	Access program mode exit	92
431	Access threat level change	93
432	Access relay/trigger fail	94
433	Access RTE shunt	95
434	Access DSM shunt	96
Arming - 440 and 450		
441	Armed Stay	97
442	Keyswitch armed Stay	98
450	Exception open/close	99

CID#	Reporting Code	Programming Value
451	Early open/close	9A
452	Late open/close	9B
453	Failed to open	9C
454	Failed to close	9D
455	Auto-arm failed	9E
456	Partial arm	9F
457	Exit error (user)	A0
458	User on premises	A1
459	Recent close	A2
System - 460		
461	Wrong code entry	A3
462	Legal code entry	A4
463	Re-arm after alarm	A5
464	Auto-arm time extended	A6
465	Panic alarm reset	A7
466	Service ON/OFF premises	A8
Sounder Relay Disabled - 520		
520	Sounder/Relay disabled	A9
521	Bell 1 disabled	AA
522	Bell 2 disabled	AB
523	Alarm relay disabled	AC
524	Trouble relay disabled	AD
525	Reversing relay disabled	AE
526	Notification appliance chk. #3 disabled	AF
527	Notification appliance chk. #4 disabled	B0
Modules - 530		
531	Module added	B1
532	Module removed	B2
Communication Disables - 550 and 560		
551	Dialer disabled	B3
552	Radio transmitter disabled	B4
Bypasses - 570		
570	Zone bypass	B5
571	Fire bypass	B6
572	24Hr. zone bypass	B7
573	Burglary bypass	B8
574	Group bypass	B9
575	Swinger bypass	BA
576	Access zone shunt	BB
577	Access point bypass	BC
Test/Misc. - 600		
601	Manual trigger test	BD
602	Periodic test report	BE

CID#	Reporting Code	Programming Value
603	Periodic RF transmission	BF
604	Fire test	C0
605	Status report to follow	C1
606	Listen-in to follow	C2
607	Walk test mode	C3
608	Periodic test - system trouble present	C4
609	Video transmitter active	C5
611	Point test OK	C6
612	Point not tested	C7
613	Intrusion zone walk tested	C8
614	Fire zone walk tested	C9
615	Panic zone walk tested	CA
616	Service request	CB
621	Event log reset	CC
622	Event log 50% full	CD
623	Event log 90% full	CE
624	Event log overflow	CF
625	Time/Date reset	D0
626	Time/Date inaccurate	D1
627	Program mode entry	D2
628	Program mode exit	D3
629	32-hour event log marker	D4
630	Schedule change	D5
631	Exception schedule change	D6
632	Access schedule change	D7
654	System inactivity	D8

Appendix 2: Automatic Report Code List

System Event	Default Contact ID Report Code	Default SIA Report Code
Arming with User Code (##)	3 4A1 - Close by user	CL - Closing report
Auto arming	3 4A3 - Automatic close	CA - Automatic closing
Late to close	3 452 - Late to close	OT - Late to close
No movement	3 452 - Late to close	NA - No activity
Partial arming	1 456 - Group bypass	CG - Close area
Quick arming	3 4A8 - Quick arm	CL - Closing report
Arm with PC software	3 4A7 - Remote arm/disarm	CQ - Remote arming
Disarm with User Code (##)	1 4A1 - Open by user	OP - Opening report
Disarm after alarm* with User Code (##)	1 4A1 - Open by user	OP - Opening report
Cancel alarm** with User Code (##)	1 4A6 - Cancel by user	OR - Disarm from alarm
Auto-arming cancellation	1 464 - Deferred open/close	CE - Closing extend
Disarm with PC software	1 4A7 - Remote arm/disarm	OQ - Remote disarming
Disarm after an alarm with PC software	1 4A7 - Remote arm/disarm	OR - Disarm from alarm
Cancel alarm with PC software	1 4A6 - Cancel by user	OR - Disarm from alarm
Cancel paramedic alarm	1 4A6 - Cancel by user	MH - Medical alarm restore
Zone bypassed (##)	1 57A - Zone bypass	UB - Untyped zone bypass
Zone alarm (##)	1 13A - Burglary alarm	BA - Burglary alarm
Fire alarm (##)	1 11A - Fire alarm	FA - Fire alarm
Zone alarm restore (##)	3 13A - Burglary alarm restore	BH - Burglary alarm restore
Fire alarm restore (##)	3 11A - Fire alarm restore	FH - Fire alarm restore
Panic 1 - emergency	1 12A - Panic alarm	PA - Panic alarm
Panic 2 - medical	1 1AA - Medical alarm	MA - Medical alarm
Panic 3 - fire	1 115 - Pull station	FA - Fire alarm
Recent closing	3 459 - Open/Close	CR - Recent closing
Global zone shutdown	1 575 - Group bypass	CG - Close area
Duress alarm	1 121 - Duress	HA - Hold-up alarm
Keypad lockout	1 421 - Access denied	JA - User code tamper
Zone shutdown (##)	1 57A - Zone bypass	UB - Untyped zone bypass
Zone tampered (##)	1 144 - Sensor tamper	TA - Tamper alarm
Zone tamper restore (##)	3 144 - Sensor tamper restore	TR - Tamper restoral
AC failure	1 3A1 - AC loss	AT - AC trouble
Battery failure	1 3A9 - Battery test failure	YT - System battery trouble
Auxiliary supply trouble	1 3AA - System trouble	YP - Power supply trouble
Bell output current limit	1 321 - Bell 1	YA - Bell fault
Bell absent	1 321 - Bell 1	YA - Bell fault
Clock lost	1 626 - Time/date inaccurate	JT - Time changed
Fire loop trouble	1 373 - Fire trouble	FT - Fire trouble
Communication fail	1 354 - Communication fail	YC - Fail to communicate
RF interference	1 344 - RF receiver jam detection	XQ - RF Interference
TLM trouble restore	3 351 - Telco 1 fault restore	LR - Phone line restoral
AC failure restore	3 3A1 - AC loss restore	AR - AC restoral
Battery failure restore	3 3A9 - Battery test restore	YR - System battery restoral

* An armed system is or was in alarm and was disarmed by a user.

** A disarmed system is or was in alarm (e.g. 24Hr. zone) and was disarmed by a user.

System Event	Default Contact ID Report Code	Default SIA Report Code
Auxiliary supply trouble restore	3 3AA - System trouble restore	YQ - Power supply restored
Bell output current limit restore	3 321 - Bell 1 restore	YH - Bell restored
Bell absent restore	3 321 - Bell 1 restore	YH - Bell restored
Clock programmed	3 625 - Time/date reset	JT - Time changed
Fire loop trouble restore	3 373 - Fire trouble restore	FJ - Fire trouble restore
Fail to communicate with monitoring station	3 354 - Fail to communicate	YK - Communication fails
RF interference	3 344 - RF receiver jam detection	XH - RF Interference Restoral
Combus fault	1 333 - Expansion module failure	ET - Expansion trouble
Module tamper	1 341 - Expansion module tamper	TA - Tamper alarm
Bus fault restore	3 333 - Expansion module failure restore	ER - Expansion restoral
Module tamper restore	3 341 - Expansion module tamper restore	TR - Tamper restoral
Cold start	1 3A8 - System shutdown	RR - Power up
Test report engaged	1 6A2 - Periodic test report	TX - Test report
PC software communication finished	1 412 - Successful - download access	RS - Remote program success
Installer on site	1 627 - Program mode entry	LB - Local program
Installer programming finished	1 628 - Program mode exit	LS - Local program success
Maintenance in	1 627 - Program mode entry	LB - Local program
Maintenance out	1 628 - Program mode exit	LS - Local program success
Closing delinquency	1 654 - System inactivity	CD - System inactivity
Module AC fail	1 342 - AC failure on module	AT - Module AC fail
Module AC fail restore	3 342 - AC restored on module	AR - Module AC fail restore
Module battery fail	1 338 - Battery failure on module	YT - Module battery fail
Module battery fail restore	3 338 - Battery failure on module	YR - Module battery fail restore
RF Module low battery	1 384 - RF transmitter low battery	XT - Transmitter battery trouble
RF Module battery restore	3 384 - RF transmitter battery restore	XR - Transmitter battery restoral
RF Module supervision trouble	1 381 - Loss of supervision - RF	US - Untype zone supervision
RF Module supervision restore	3 381 - Supervision restore - RF	UR - Untyped zone restoral
RF Module supervision lost	1 381 - Loss of supervision- RF	US - Untyped Zone Supervisory
RF Module supervision restore	3 381 - Loss of supervision- RF restore	UR - Untyped Zone Restoral
RF Module tamper	1 145 - Expansion module tamper	ES - Expansion Device Tamper
RF Module tamper restore	3 145 - Expansion module tamper restore	EJ - Expansion Device Restore
Paramedic alarm	1 1AA - Medical	MA - Medical Alarm
Zone forced	1 57A - Zone forced	XW - Zone forced
Zone included	3 57A - Zone included	UU - Zone included
Keyswitch arm	34A9 - Keyswitch arm	CS - Keyswitch arm
Keyswitch disarm	14A9 - Keyswitch disarm	OS - Keyswitch disarm
Keyswitch disarm after alarm	14A1 - Keyswitch disarm after alarm	OS - Keyswitch disarm after alarm
Keyswitch cancel alarm	14A6 - Keyswitch cancel alarm	OS - Keyswitch cancel alarm

Appendix 3: Data Entry & Display

To access the Data Display Mode, press the [ENTER] key after entering a section and before entering any data. The four LEDs as indicated below will begin to flash indicating that you are in the Data Display Mode.



Each time the [ENTER] key is pressed, the keypad will display the next digit in the current section and will continue through all the following sections one digit at a time without changing the programmed values. Not available for sections using the Multiple Feature Select Method. Press the [CLEAR] key at any time to exit the Data Display Mode.

There are two methods that can be used to enter data when in programming mode: Single Digit Data Entry and Feature Select Programming methods.

Single Digit Data Entry Method

After entering programming mode, some sections will require that you enter decimal values from 000 to 255. Other sections will require that you enter hexadecimal values from 0 to F. The required data will be clearly indicated in this manual. When entering the final digit in a section, the panel will automatically save and advance to the next section. Refer to *Decimal and Hexadecimal Values* on page 50 to see the keys and their equivalent decimal and/or hexadecimal value.

Feature Select Programming Method

After entering certain sections, eight options will be displayed where each option from [1] to [8] represents a specific feature. Press the key corresponding to the desired option. This means the option is ON. Press the key again to remove the digit, thereby, turning OFF the option. Press the [CLEAR] key to set all eight options to OFF. When the options are set, press the [ENTER] key to save and advance to the next section.

Decimal and Hexadecimal Values

Value or Action	What Do I Press?	What Do I See?	
		32-zone LED	10-zone LED
Value 0 / Replace Current Digit with 0	[SLEEP]	Erase digit and remain in section	Erase digit and remain in section
Values 1 to 9	[1] to [9]	Zone 1 to 9	Keys 1 to 9
A (hex only)	[0]	Zone 10	Key 0(10)
B (hex only)	[OFF]	Zone 11	OFF
C (hex only)	[BYP]	Zone 12	BYP
D (hex only)	[MEM]	Zone 13	MEM
E (hex only)	[TBL]	Zone 14	TBL
F (hex only)	[⏻]	Zone 15	[⏻]
Exit Without Saving	[CLEAR]	ARM & STAY LED flash	ARM & STAY LED flash
Save Data (hex only)	[ENTER]	Advances to the next section	Advances to the next section

Trouble Display

- Press the **[TBL]** key to view the Trouble Display. Please note that the keypad can be programmed to emit a beep every 5 seconds whenever a new trouble condition has occurred. Press the **[TBL]** key to stop the beeping.
- To view the sub-menu, press the corresponding key in the main menu.

Main Menu Trouble	Sub-Menu Trouble Menu
[1] Wireless zone low battery	[1] to [32] Zones in low battery
[2] Power trouble	[1] Low/No battery on the control panel [2] AC failure on control panel [3] Auxiliary overload on control panel [4] Wireless keypad AC failure [5] Wireless keypad battery failure [6] Wireless repeater AC failure [7] Wireless repeater battery failure
[3] Bell trouble	[1] Bell disconnect on control panel [2] Bell overload on control panel
[4] Communication trouble	[1] Telephone Line Monitoring on control panel [2] Fail to communicate on Monitoring Telephone 1 on control panel [3] Fail to communicate on Monitoring Telephone 2 on control panel [4] Fail to communicate on pager telephone on control panel [5] Fail to communicate on voice telephone on control panel [6] Fail to communicate with PC on control panel
[5] Tamper and zone wiring failure	[1] to [32] Zones in tamper and zone wiring failure
[6] Module tamper trouble	[1] MG-2WPGM [2] Keypad bus [3] ZX8 bus module [4] RTX3 bus module [5] Wireless keypad
[7] Fire loop trouble	[1] to [32] Zones in fire loop trouble
[8] Timer loss	
[9] Wireless zone supervision loss	[1] to [32] Zones in supervision lost [STAY] RF interference trouble
[0 (10)] or [10] Module supervision loss	[1] MG-2WPGM [2] Keypad bus (Panel reset will not clear this trouble, clear it in section [955]) [3] ZX8 bus module [4] RTX3 bus module [5] Wireless keypad supervision failure [6] Wireless repeater supervision failure
[16] Keypad fault (MG32LED/MG32LRF only)	
[SLEEP] Keypad fault (MG10LEDV/H only)	

Installer Function Keys

To access the Installer Function keys, press:

[ENTER]+[INSTALLER CODE] + [MEM] = *Test Report*: Send the "Test Report" report code programmed in section **[875]** (page 44) to the monitoring station.

[ENTER]+[INSTALLER CODE] + [STAY] = *Cancel Communication*: Cancels all communication with the WinLoad software or with the monitoring station until the next reportable event.

[ENTER]+[INSTALLER CODE] + [SLEEP] = *Answer WinLoad Software*: Will force the console to answer an incoming call from the monitoring station that is using the WinLoad software.

[ENTER]+[INSTALLER CODE] + [BYP] = *Call WinLoad Software*: Will dial the PC telephone number programmed in section **[915]** (page 45) in order to initiate communication with a computer using the WinLoad software.

[ENTER]+[INSTALLER CODE] + [TBL] = *Installer Test Mode*: The installer test mode will allow you to perform walk tests where the siren will squawk to indicate opened zones. Press the **[TBL]** key again to exit.

Hardware Connections

Single Zone Inputs

N.C. Contacts, No EOL

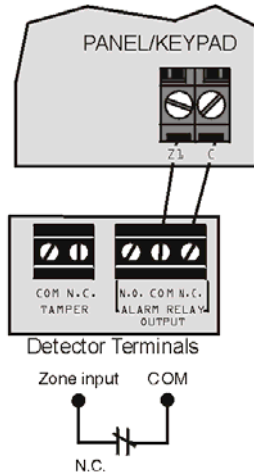

**N.C., With EOL
UL/ULC Configuration**

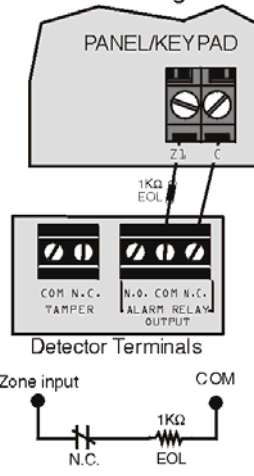

**N.O., With EOL
UL/ULC Configuration**

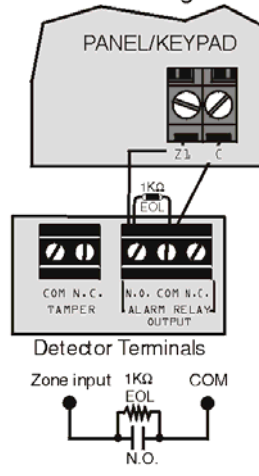

**N.C. Contacts, No EOL,
With Tamper Recognition**

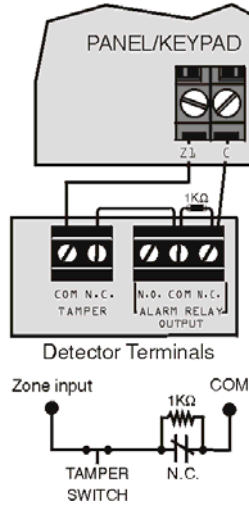

**N.C., With EOL, With Tamper &
Wire Fault Recognition (UL/ULC)**

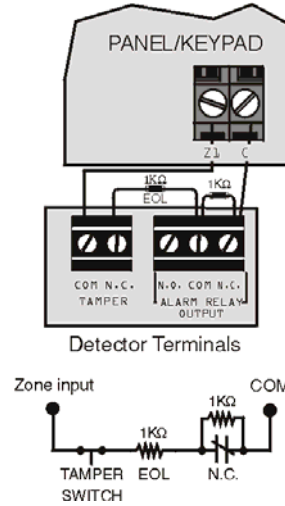

Advanced Technology Zone (ATZ) Connections

N.C. Contacts, No EOL

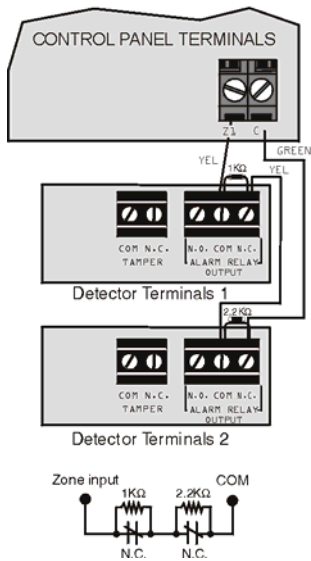

N.C. Contacts, No EOL, with Tamper Recognition

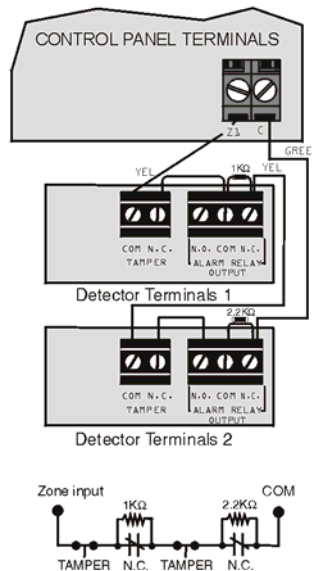

N.C. Contacts, with EOL, with Tamper and Wire Fault Recognition (UL/cUL)

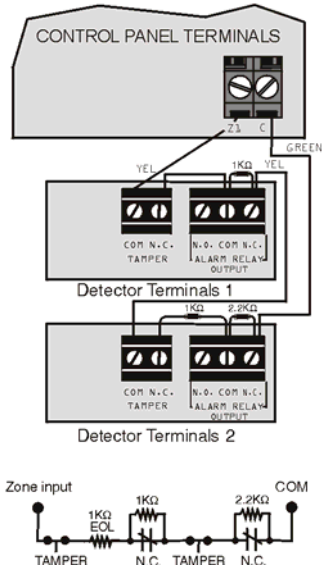

Parallel Wiring

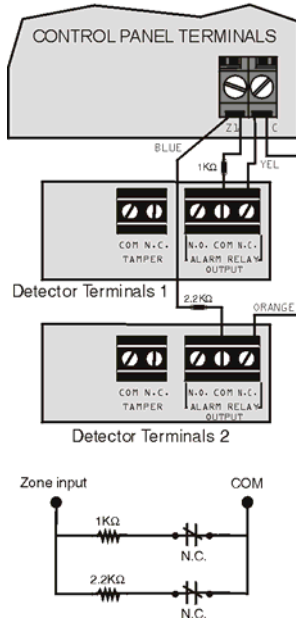

Connecting Fire Circuits and PGMs



For 4-wire installation:
Program the Activation Event so that the smoke detectors can be reset by pressing the **[CLEAR] + [ENTER]** keys for three seconds. See Event Group # 6 on page 18. For 2-wire installation (except SP5500): Press **[CLEAR] + [ENTER]** to automatically reset smoke.



All 4-wire smoke detectors must be connected using the daisy chain configuration.



Each control panel (except the SP5500) supports a maximum of five 2-wire smoke detectors.

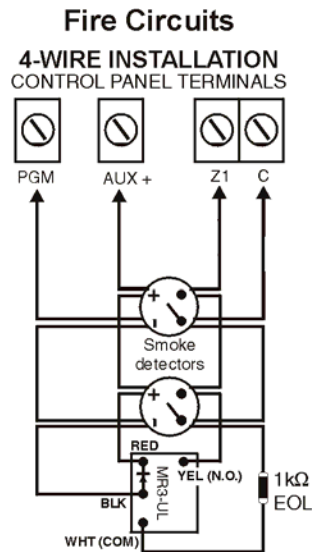

2-WIRE INSTALLATION

CONTROL PANEL TERMINALS

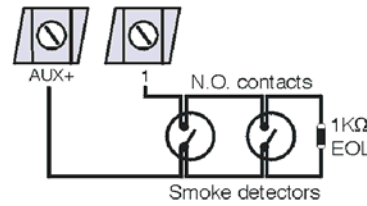

PGM

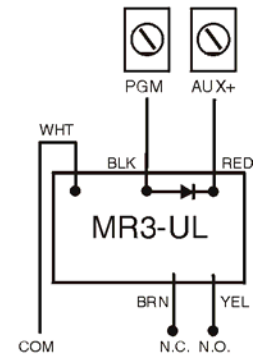

Alarm Relay and PGM Connections

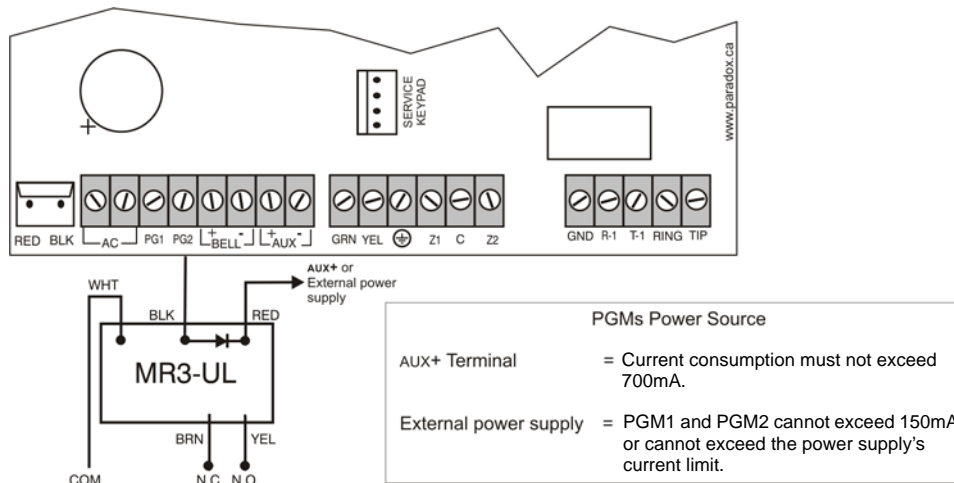

AC Power & Backup Battery Connections

Transformer Requirements Table

Transformer:	16VAC 20VA* (Amseco XP-1620) 16.5VAC 40VA (Universal UB1640W) *not verified by UL
DC Power Supply rated at:	MG5000/MG5050 = 1.0A SP5500/SP6000/SP7000 = 1.4A
Auxiliary Supply can provide a maximum of:	typ: 600mA max: 700mA UL installations: typ. 200mA
Acceptable Battery Charge Currents (section [700] option [2])	350mA/700mA

Rechargeable Battery
UL/ULC - 12Vdc / 4Ah or 7Ah

Partial view of control panel

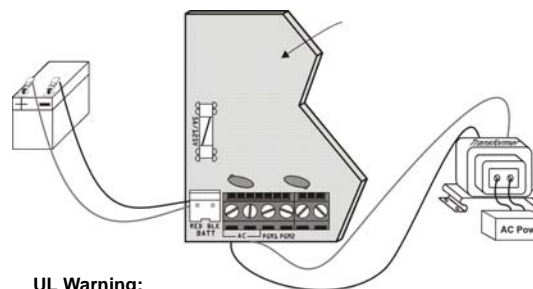

Improper connection of the transformer may result in damage to the system.

UL Warning:

A 12Vdc / 7Ah battery is required to comply with UL fire requirements.

Caution:

Disconnect battery before replacing the fuse.

Connecting to WinLoad

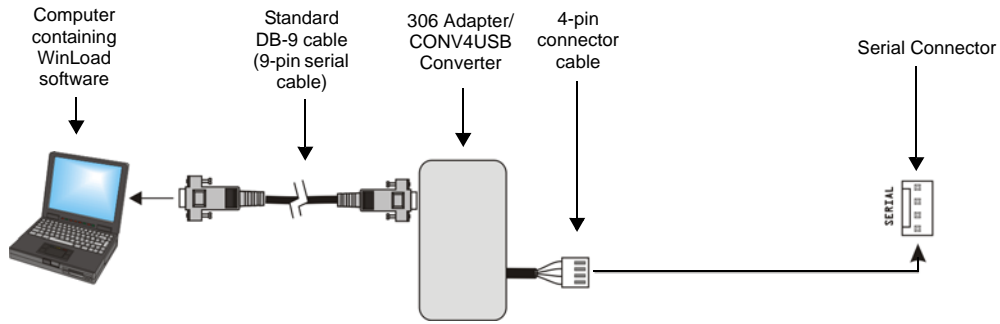

Updating Firmware Using WinLoad

To update your system firmware:

1. Connect the product to your computer using a 307USB Direct Connect Interface or CONV4USB Converter.
2. Start WinLoad Installer Upload/Download Software.
3. Click the **In-field Programmer button**. 
4. Verify the product information located in the In-Field Firmware Programmer window.
If the firmware programmer does not automatically detect your control panel, click the **Com port settings** button and select the correct Com port. Then click the **Refresh Product Info** button to connect with the panel.
5. To check for new updates, click the **Download Firmware from the web** button.
6. From the Select Firmware drop-down box, select the firmware version you wish to install.
or
If you have already downloaded the .pef file from paradox.com, click the [...] button and select the location of the .pef file.
7. Click the **Update product firmware** button.
When the download process finishes, the update is complete.

Metal Box Installation

The crosses and dotted line represent the mounting location. If you need specific dimensions, contact Paradox Distributor Support. For UL recommended installation for the MG5000 only, place the PCB one notch lower than the mounting location.

MG5000 (8x10")

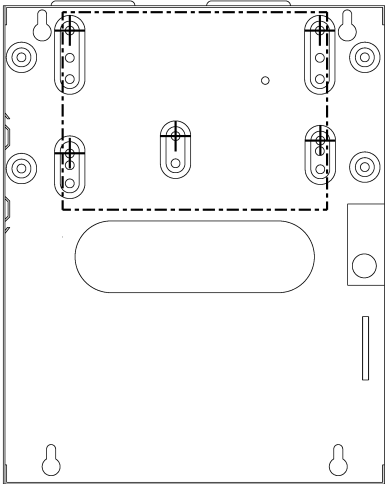

MG5000 (11x11")

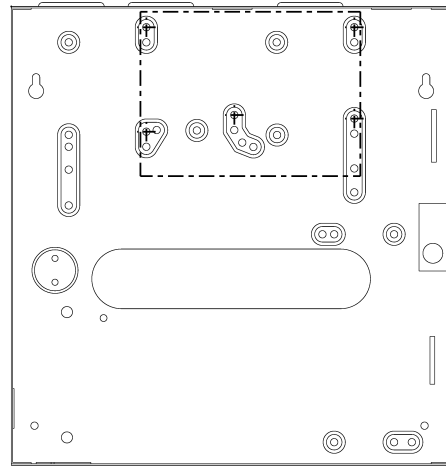

MG5050 (11x11")

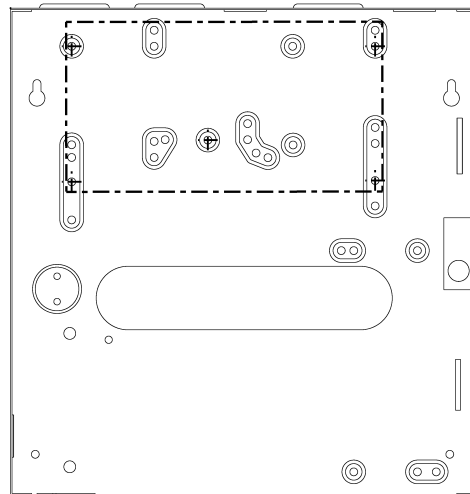

SP5500 (8x10")

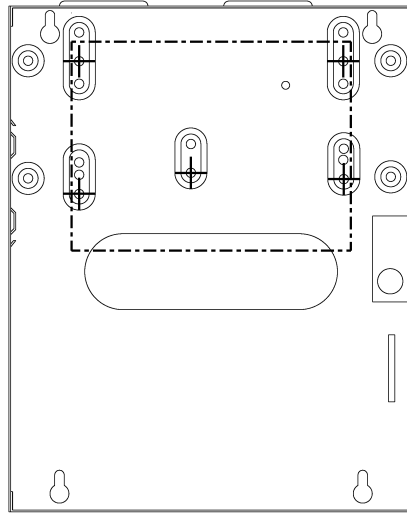

SP6000 (11x11")

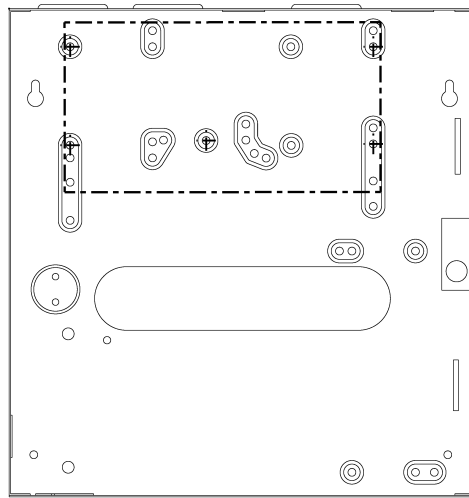

SP7000 (11x11")

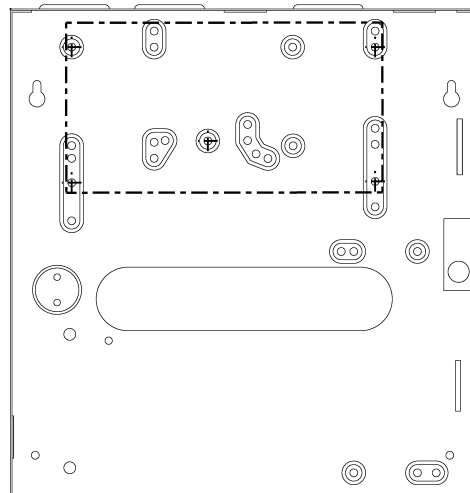

MG5000 PCB Layout

Used for In-Field Firmware upgrade through a 307USB Direct Connect Interface. See Connecting to WinLoad on page 55 for details.

EBUS and Dialer: Used with the VDM P3 plug-in voice module for voice reporting.

Press and hold the RESET button for five seconds. The STATUS LED will start flashing. Within 2 seconds of this flashing, press the reset switch again. The panel will reset to default and restart.

Four pin connector can be used for quick installation of a keypad.



Refer to AC Power & Backup Battery Connections on page 54.

The "BELL" output will shutdown if the current exceeds 3A.

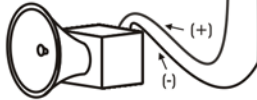

Connection for Self-Contained Bell/Siren

Warning: The sum of the current drawn from the BELL and AUX must be limited to 1.3A (40VA transformer strongly recommended). Exceeding this limit will overload the panel power supply and lead to complete system shutdown.

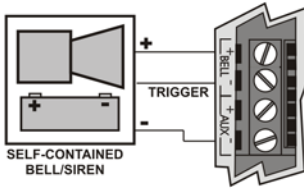

AUX Power

Refer to transformer requirements on page 54 for Aux. Power Output. To connect additional wiring to auxiliary power, use the red (+) and black (-) keypad connectors. Auxiliary power will shut down if current exceeds 1.1A. If the auxiliary output is overloaded and is shut down, you must disconnect all loads from the output for at least 10 seconds before reconnecting any load back to the auxiliary output.

Warning: This equipment must be installed and maintained by qualified service personnel only. For UL and C-UL warnings, refer to the UL and C-UL Warnings section at the back of the Reference & Installation Manual.

Charge LED:
Charging and Battery test LED

"STATUS" LED:
Flash once every second = Normal
Flashes ON 1 second and OFF 1 second = Any trouble
Always ON = Panel is using phone line
Fast flash 6 seconds after power up = Installer lock enabled

"RX" & "TX" LED:
Flashes quickly when receiving or transmitting RF signals from wireless devices.

Warning: Do not cut, bend or alter the antennas and ensure that electrical wires do not cross over the antennae, as this may affect signal reception.

Warning: Disconnect telephone line before servicing.

Paradox Memory Key (PMC-4 PMC-5)

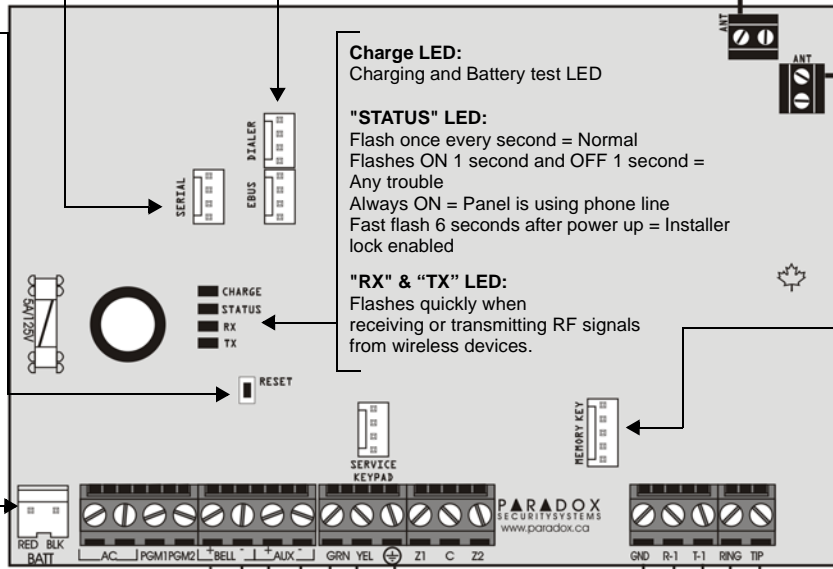

Refer to Single Zone Inputs on page 52

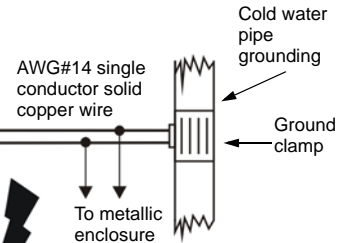

Warning: To provide maximum lightning protection we strongly recommend having separate earth connections for the dialer and zone ground terminals.

Warning: Max. amount of keypads = 15 keypads
Max. current = 700 mA
Max. distance of keypad from panel = 76m (250 feet)
Max. total run of wire = 230m (750 feet)

* If EOL is enabled: see section [706] option [2]. For the keypad's zone configurations, refer to Installer Quick Menu on page 3. Also refer to keypad zone connections on page 52.

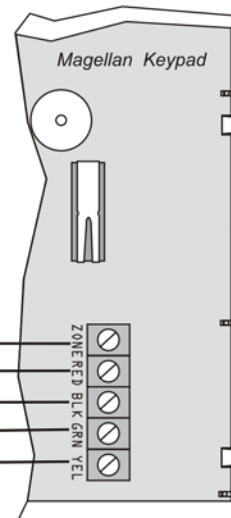

For the keypad's zone configurations, refer to the Installer Quick Menu. If EOL is enabled: see section [706] option [2]. Also refer to Keypad Zone Connections on page 52.

MG5050 PCB Layout

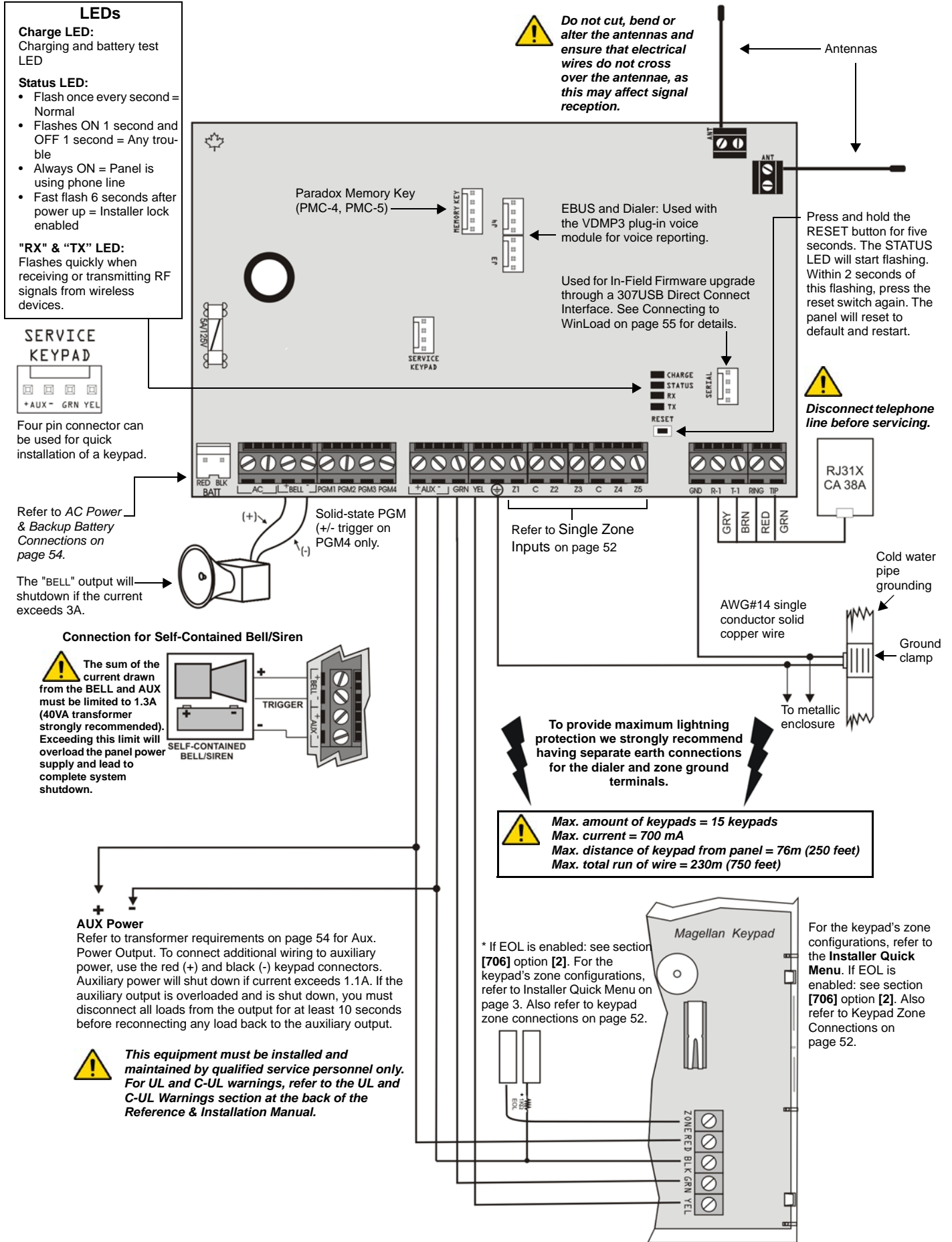

SP5500 PCB Layout

LEDs

Charge LED:
Charging and battery test LED

Status LED:

- Flash once every second = Normal
- Flashes ON 1 second and OFF 1 second = Any trouble
- Always ON = Panel is using phone line
- Fast flash 6 seconds after power up = Installer lock enabled

Used for In-Field Firmware upgrade through a 307USB Direct Connect Interface. See Connecting to WinLoad on page 55 for details.

Four pin connector can be used for quick installation of a keypad.

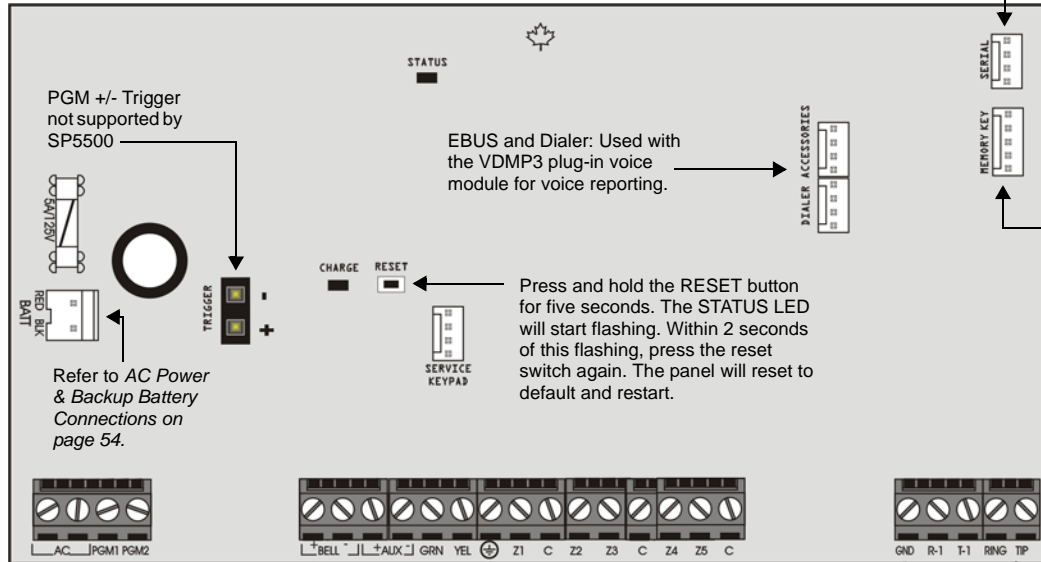

The "BELL" output will shutdown if the current exceeds 3A.

AUX Power

Refer to transformer requirements on page 54 for Aux. Power Output. To connect additional wiring to auxiliary power, use the red (+) and black (-) keypad connectors. Auxiliary power will shut down if current exceeds 1.1A. If the auxiliary output is overloaded and is shut down, you must disconnect all loads from the output for at least 10 seconds before reconnecting any load back to the auxiliary output.

Connection for Self-Contained Bell/Siren

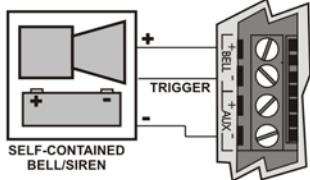

The sum of the current drawn from the BELL and AUX must be limited to 1.3A (40VA transformer strongly recommended). Exceeding this limit will overload the panel power supply and lead to complete system shutdown.

Refer to Single Zone Inputs on page 52

To provide maximum lightning protection we strongly recommend having separate earth connections for the dialer and zone ground terminals.

- Max. amount of keypads = 15 keypads**
- Max. current = 700 mA**
- Max. distance of keypad from panel = 76m (250 feet)**
- Max. total run of wire = 230m (750 feet)**

* If EOL is enabled: see section [706] option [2]. For the keypad's zone configurations, refer to Installer Quick Menu on page 3. Also refer to keypad zone connections on page 52.

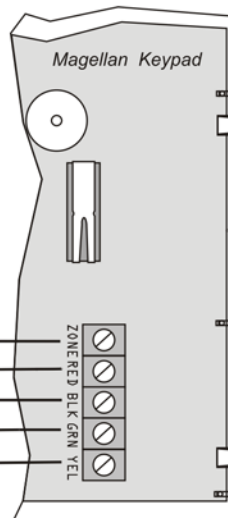

For the keypad's zone configurations, refer to the **Installer Quick Menu**. If EOL is enabled: see section [706] option [2]. Also refer to Keypad Zone Connections on page 52.

This equipment must be installed and maintained by qualified service personnel only. For UL and C-UL warnings, refer to the UL and C-UL Warnings section at the back of the Reference & Installation Manual.

SP6000 PCB Layout

LEDs

Charge LED:
Charging and battery test LED

Status LED:

- Flash once every second = Normal
- Flashes ON 1 second and OFF 1 second = Any trouble
- Always ON = Panel is using phone line
- Fast flash 6 seconds after power up = Installer lock enabled

Used for In-Field Firmware upgrade through a 307USB Direct Connect Interface. See Connecting to WinLoad on page 55 for details.

Four pin connector can be used for quick installation of a keypad.

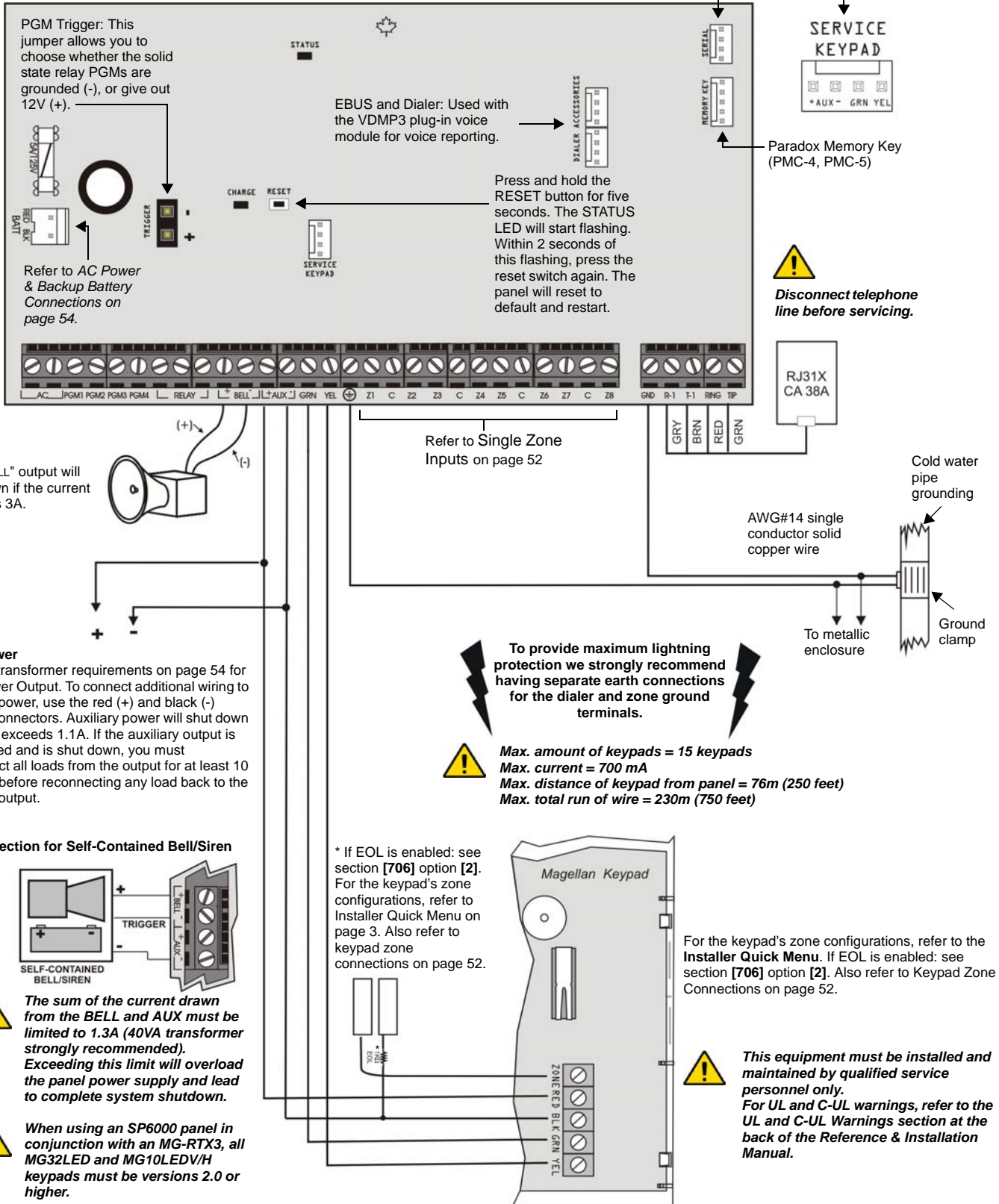

SP7000 PCB Layout

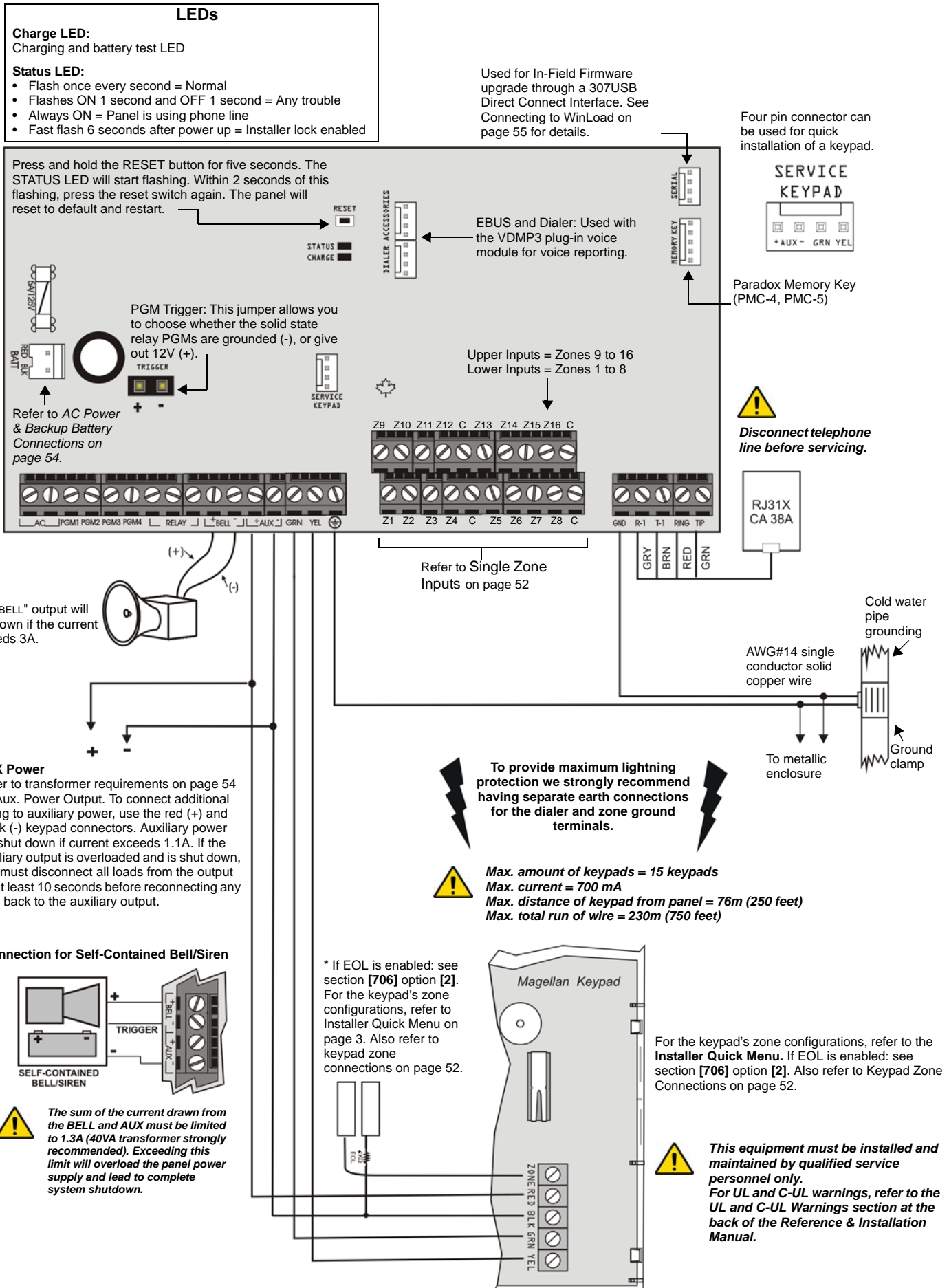

Warranty

For complete warranty information on this product please refer to the Limited Warranty Statement found on the website www.paradox.com/terms. Your use of the Paradox product signifies your acceptance of all warranty terms and conditions.

Limitations of Alarm Systems:

It must be understood that while your Paradox alarm system is highly advanced and secure, it does not offer any guaranteed protection against burglary, fire or other emergency (fire and emergency options are only available on certain Paradox models). This is due to a number of reasons, including but not limited to inadequate or improper installation/positioning, sensor limitations, battery performance, wireless signal interruption, inadequate maintenance or the potential for the system or telephone lines to be compromised or circumvented. As a result, Paradox does not represent that the alarm system will prevent personal injury or property damage, or in all cases provide adequate warning or protection.

Your security system should therefore be considered as one of many tools available to reduce risk and/or damage of burglary, fire or other emergencies, such other tools include but are not limited to insurance coverage, fire prevention and extinguish devices, and sprinkler systems.

We also strongly recommend that you regularly maintain your security systems and stay aware of new and improved Paradox products and developments.

TBR-21: In order to comply with TBR-21, standard force dialing must be enabled.

UL AND ULC WARNINGS

This equipment has the capability of being programmed with features not verified for use in UL installations. To stay within UL and ULC standards, the installer should use the following guidelines when configuring the system:

- All components of the system should be UL listed for the intended application.
- If used for "Fire" detection, the installer should refer to NFPA Standards #72, Chapter 2. In addition, once installation is complete, the local fire authority must be notified of the installation.
- WARNING: This equipment must be installed and maintained by qualified service personnel only
- This equipment must be verified by a qualified technician once every three years.
- All keypads must use an anti-tamper switch.
- Do not bypass fire zones.
- Maximum allowed entry delay is 45 seconds.
- Maximum allowed exit delay is 60 seconds.
- Minimum 4 minutes for bell cut-off time.
- The following features do not comply with UL requirements: Bypass Recall and Auto Trouble Shutdown.
- Do not connect the primary indicating device to a relay. The installer must use the bell output.
- To comply with UL985, the auxiliary power output should not exceed 200mA.
- Do not connect the zone ground terminal with UL Listed products.
- The metallic enclosure must be grounded to the cold water pipe.
- All outputs are Class 2 or power-limited, except for the battery terminal. The Class 2 and power-limited fire alarm circuits shall be installed using CL3, CL3R, CL3P, or substitute cable permitted by the National Electrical Code, ANSI/NFPA 70.
- EOL resistor part #2011002000
- **For UL Installations:** Universal UB1640W 16.5VAC min **40VA**
- All outputs are rated from 11.3Vdc to 12.7Vdc
- 12Vdc 4Ah rechargeable acid/lead or gel cell backup battery (YUASA model #NP7-12 recommended) for residential use. Use a 7Ah battery to comply with fire requirements.
- Wheelock 46T-12 siren

Legal

© 2004-2007 Paradox Security Systems Ltd. All rights reserved. Specifications may change without prior notice. One or more of the following US patents may apply: 7046142, 6215399, 6111256, 6104319, 5920259, 5886632, 5721542, 5287111, 5119069, 5077549 and RE39406. Canadian and international patents may also apply. Magellan and Spectra SP are trademarks or registered trademarks of Paradox Security Systems Ltd. or its affiliates in Canada, the United States and/or other countries.

P ▲ R ▲ D O X[®]
S E C U R I T Y S Y S T E M S

paradox.com

Printed in Canada - 11/2007

MGSP-EP14