

MS-6905 CPU Converter Board

INSTALLATION GUIDE

Features

- Converts socket Intel Celeron™ processor into Slot 1
- Easy upgrade to a newer Intel Celeron™ processor
- Reduce mainboard cost
- More CPU compatible options for Slot 1 mainboard

Dimension

- 12.9(W)cm x 6.8(H)cm x 4 Layers

MS-6905 Installation Guide

MS-6905 CPU Converter & Processor Board Brace (L/R)

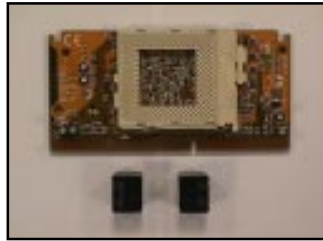

1. Open the socket lever

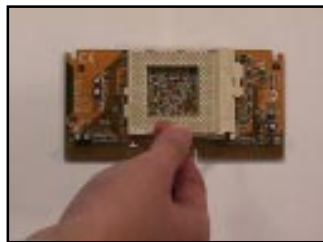

2. Insert the processor into the socket. Then, close the socket lever.



3. Attach the Heat Sink w/ Fan into the processor.



4. Insert MS-6905 CPU Converter Board into Slot 1.

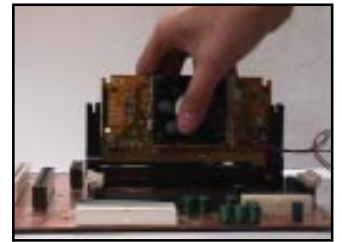

5. Attach Processor Board Brace (right) to secure MS-6905. Look for the "R" mark on the Processor Board Brace.

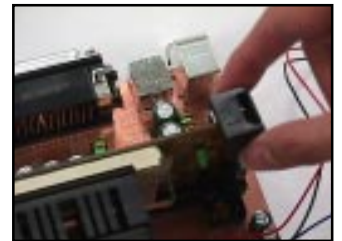

6. Attach Processor Board Brace (left) to secure MS-6905. Look for the "L" mark on the Processor Board Brace.



The processor is now secure into Slot 1. Thus, completing the installation.



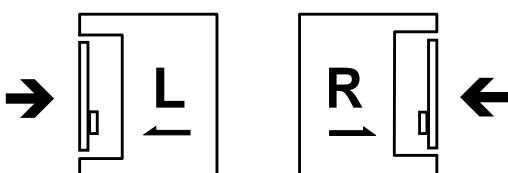

Procedure for detaching Processor Board Brace



Removing the Processor Board Brace:

- Push the Processor Board Brace Lock inward.
- Pull the Processor Board Brace

Overclocking Jumper: J1

Feature	J1
Automatically detect 66MHz and 100MHz FSB	short 
Virtually set 66MHz to 100MHz FSB	open 

Note This jumper is only used for overclocking. We do not guarantee that the mainboard, CPU, or other components will function properly under these conditions.



MICRO-STAR
INTERNATIONAL

MS-6905 Jumper Setting

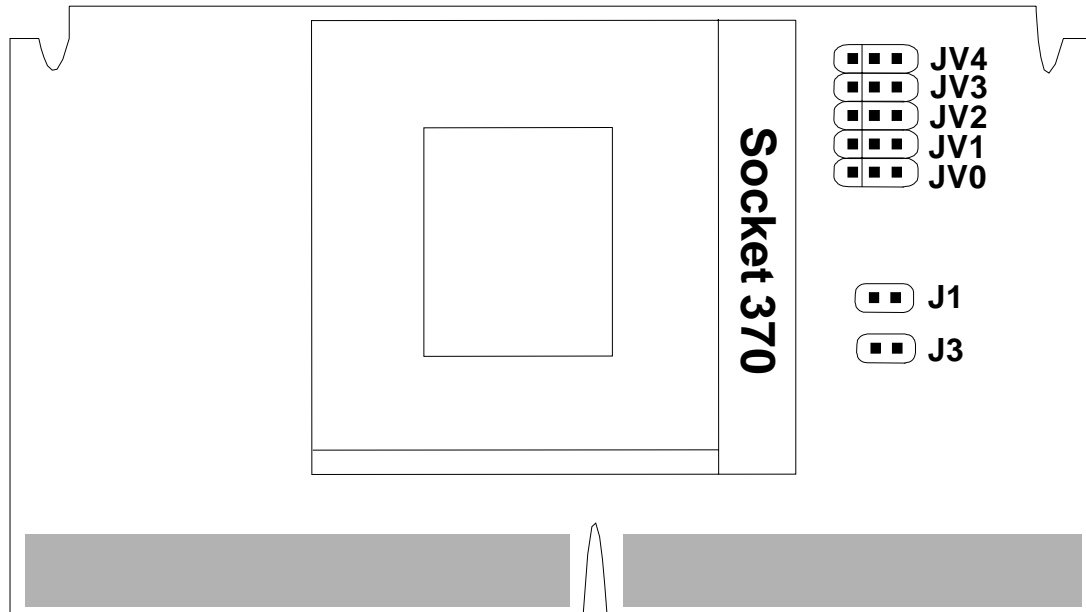

Overclocking Jumper: J1

Feature	J1
Automatically detect 66MHz and 100MHz FSB	short
Virtually set 66MHz to 100MHz FSB	open

Note This jumper is only used for overclocking. We do not guarantee that the mainboard, CPU, or other components will function properly under these conditions.

Single/Dual Processor Jumper: J3

Feature	J3
Single processor	open
Dual processor	short

Note This jumper will enable you to use dual processor. By shorting J3, you can use two MS-6905 converter board on a dual processor mainboard. We do not guarantee that the mainboard, CPU, or other components will function properly under these conditions.

Voltage Jumper

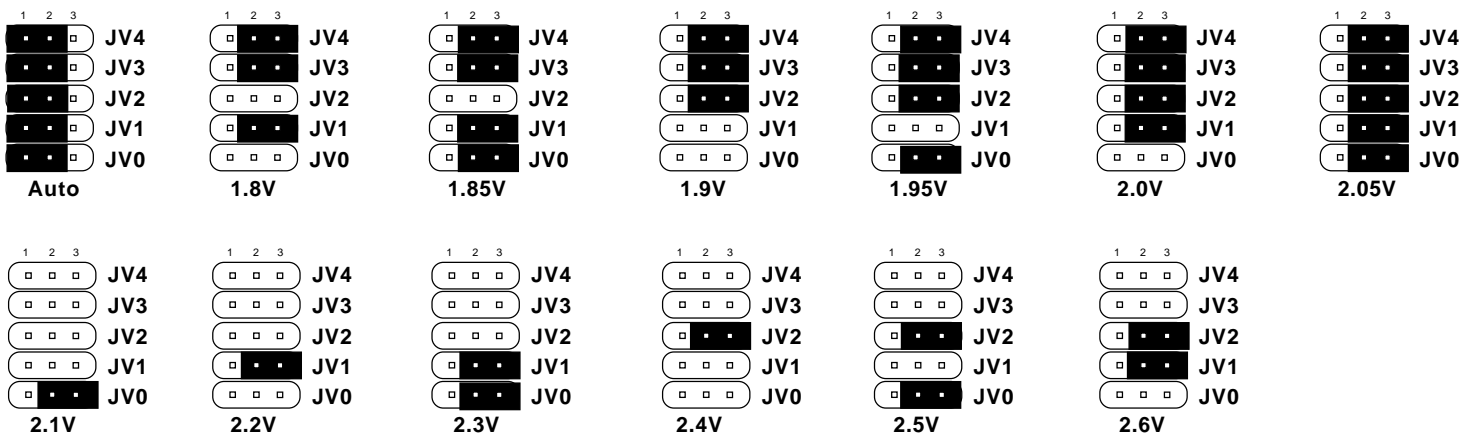

Note These jumper should always be set to Auto by default. We do not guarantee that the mainboard, CPU, or other components will function properly when the voltage is manually set..