

PX915-SLI

Copyright

All rights are reserved. No part of this publication may be reproduced, transmitted, transcribed, stored in a retrieval system or translated into any language or computer language, in any form or by any means, electronic, mechanical, magnetic, optical, chemical, manual or otherwise, without the prior written permission of the company. Brands and product names are trademarks or registered trademarks of their respective companies.

The vendor makes no representations or warranties with respect to the contents herein and especially disclaim any implied warranties of merchantability or fitness for any purpose. Further the vendor reserves the right to revise this publication and to make changes to the contents herein without obligation to notify any party beforehand. Duplication of this publication, in part or in whole, is not allowed without first obtaining the vendor's approval in writing.

Trademark

All the trademarks or brands in this document are registered by their respective owner.

Disclaimer

We make no warranty of any kind with regard to the content of this user's manual. The content is subject to change without notice and we will not be responsible for any mistakes found in this user's manual. All the brand and product names are trademarks of their respective companies.

FCC Compliance Statement

This equipment has been tested and found to comply with the limits of a Class B digital device, pursuant to Part 15 of the FCC Rules. These limits are designed to provide reasonable protection against harmful interference in a residential installation. This equipment generates, uses and can radiate radio frequency energy and, if not installed and used in accordance with the instructions, may cause harmful interference to radio communications. Operation of this equipment in a residential area is likely to cause harmful interference in which case the user will be required to correct the interference at his own expense. However, there is no guarantee that interference will not occur in a particular installation.

CE Mark

The device is in accordance with 89/336 ECC-ENC Directive.

PX915-SLI
Intel® 915PL & ICH6
Support Socket 775
Intel® Pentium® 4 Prescott Processor

User Manual

Enabling the Hyper-Threading Technology, your computer system is required to have components as the following:

- **CPU:** An Intel® Pentium® 4 Processor with HT Technology
- **Chipset:** An Intel® Chipset that supports HT Technology
- **BIOS:** A BIOS that supports HT Technology must be enabled
- **OS:** An operating system that supports HT Technology

For more information on Hyper-Threading Technology, go to:
<http://www.intel.com/info/hyperthreading>

Dimensions (ATX form-factor):

- 220mm x 295mm (W x L)

Operating System:

- Windows® 2000/ XP

Things You Have To Know

- The images and pictures in this manual are for reference only and may vary from the product installed depending on specific hardware models, third party components and software versions.
- Unplug your computer system when installing components and configuring switches and pins.
- This mainboard contains very delicate IC chips. Use a grounded wrist strap when working with the system.
- Do not touch the IC chips, leads, connectors or other components.
- Unplug the AC power when you install or remove any device on the mainboard.

Packing List

- PX915-SLI mainboard
- IDE Cable
- FDC Cable
- I/O Bracket
- Bridge Card
- SATA Power Cord (optional)
- SATA Cable (optional)
- Mainboard Setup Driver CD
- Mainboard User Manual CD
- Mainboard Quick Installation Guide

Symbols

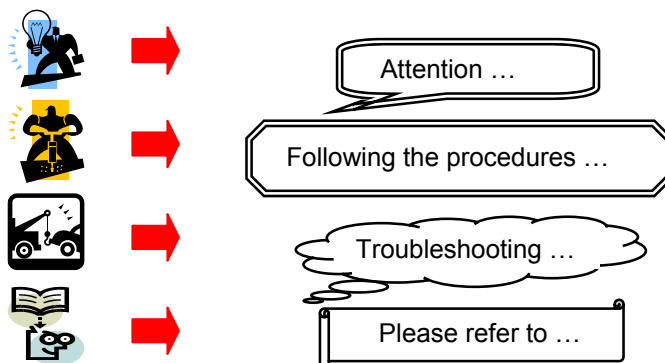

Table of Contents

CHAPTER 1. GETTING STARTED	1
INTRODUCTION.....	1
SPECIFICATION	2
CONFIGURATION	5
Layout of PX915-SLI	5
HARDWARE INSTALLATION	6
CPU Processor Installation.....	6
Memory Installation	7
Back Panel Configuration.....	9
Connectors.....	11
Front Panel Headers: SW/LED · PW/LED · SPEAKER	12
Headers & Jumpers.....	13
Audio Configuration.....	15
Slots	16
Power Supply Attachments.....	16
CHAPTER 2. BIOS SETUP.....	17
INTRODUCTION.....	17
MAIN MENU	19
ADVANCED BIOS FEATURES	20
PERIPHERALS.....	27
POWER MANAGEMENT	32
HARDWARE MONITOR.....	35
DEFAULTS	36
EXIT MENU.....	37
CHAPTER 3: SOFTWARE SETUP.....	38
SOFTWARE INSTALLATION.....	38
CHAPTER 4: TROUBLESHOOTING.....	40
APPENDIX I: SUPER 5.1 CHANNEL AUDIO EFFECT SETUP	43
APPENDIX II: BRIDGE CARD SETUP.....	44
APPENDIX III: ABS (ALBATRON BIOS SECURITY) CARD SETUP	44

Chapter 1. Getting Started

Introduction

Thanks for choosing PX915-SLI Mainboard. It is based on Intel® 915PL Northbridge chipset and Intel® ICH6 Southbridge chipset. It supports Intel® Pentium® 4 Prescott Processor with FSB (Front Side Bus) 533/800 MHz.

The PX915-SLI provides two DIMM (Dual In-Line Memory Modules) sockets which you can insert 184-pin unbuffered and non-ECC DDR SDRAMs. The DIMMs also support DDR400 (PC3200)/ DDR333 (2700) and a total memory capacity of 2 GB in dual channel mode.

This mainboard provides two PCI-E x16 slots which individual can support up to 16 times and 4 times performed speeds, and support users to insert two dual graphic cards for multiple display (up to four separated monitors are supported at the same time). In addition, via the Bridge Card setup (**See Appendix II**), the improved PCI-Express bandwidth will provide highly efficiency. This mainboard also provides two PCI slots for expansion cards use.

The PX915-SLI provides one floppy disk drive connector with 360KB/ 720KB/ 1.2MB/ 1.44MB/ 2.88MB supported and one IDE connector with Ultra ATA 66/ 100/ 133 supported for hard disk drives. This mainboard also has onboard Serial ATA, four SATA connectors are compatible the SATA 1.0 specification and with 150 MBps transmission speeds.

The onboard AC' 97 sound codec supports the high quality 6-channel audio play (Super 5.1 Channel Audio Effect) (**See Appendix I**) and also supports the Sony/Philips Digital Interfaces (SPDIF) function (the SPDIF IN/OUT port is optional).

There are maximal eight USB2.0/ 1.1 ports can be set on this mainboard.

The PX915-SLI also comes with an onboard 10/100 MBps (or 1GBps as optional) Ethernet LAN chip. You can directly plug an Internet cable into the LAN port on your back panel case for a network setting

In addition, this mainboard supports the ABS (Albatron BIOS Security) function, which provides a backup BIOS while inserting an ABS card (optional) onto the mainboard header. Once you insert this ABS card, then you will no need to worry as the system cannot be powered on due to the onboard BIOS is damaged (**See Appendix III**).

All the information (including hardware installation and software installation) in this manual are for reference only. The contents in this manual will be updated without notice. If there is any mistake, no responsibility will cause for the company.

Specification

CPU:

- Support Socket 775 Pentium® 4 Prescott Processor
- Support Hyper-Threading Technology
- Support FSB (Front Side Bus) 533/ 800 MHz

Chipset:

- Northbridge Chipset – Intel® 915PL
- Southbridge Chipset – Intel® ICH6
- I/O Controller – Winbond® W83627THF
- AC' 97 Sound Codec – Realtek® ALC655
- Mb LAN Controller – Realtek® RTL 8100C
- Gb LAN Controller – Realtek® RTL 8110S (Optional)

Memory:

- Support Dual Channel DDR400 (PC3200)/ DDR333 (PC2700)
- Support unbuffered and non-ECC DDR SDRAM
- Support two DIMM (Dual In-Line Memory Modules) sockets, and a total memory capacity of 2GB

Slots:

- Support two PCI-Express interface slots:
 1. PCI-E x16 slot: Support the maximal 16 times performed speeds
 2. PCI-E1 slot: Support the maximal 4 times performed speeds
- Support two PCI interface slots

FDD Connector:

- Support to set up to two floppy disk drives
- Support 360KB/ 720KB/ 1.2MB/ 1.44MB/ 2.88MB

IDE Connector:

- Support to set up to two IDE devices
- Support Ultra ATA 66/ 100/133

Mainboard PX915-SLI

- High capacity hard disk drives connecting are supported

Serial ATA Connector:

- Support to set up to four SATA hard disk drives
- Support SATA 1.0 specification and with 150MBps transmission speeds

Onboard AC' 97 Sound Codec:

- High performance Codec with high S/N ratio (>90 db)
- Compliant with AC' 97 2.3 specification
- Support 6 channel playback capability (Super 5.1 Channel Audio Effect)
- Support 3D stereo enhancement
- Support Sony/ Philips Digital Interfaces (S/PDIF) function

Onboard LAN Chip:

- 10/100 Mbps (or 1Gbps as optional) Ethernet LAN supported

Onboard I/O facilities:

- One multi-mode Parallel Port is capable to support as the following:
 1. Standard & Bi-direction Parallel Port
 2. Enhanced Parallel Port (EPP)
 3. Extended Capabilities Port (ECP)
- Support one serial port
- Support one PS/2 mouse and one PS/2 keyboard
- Support one Game PORT header (Optional) and one SPDIF header

Universal Serial Bus:

- Support to set maximal eight USB 2.0 ports for USB compliant interface devices

BIOS:

- Phoenix-Award™ BIOS
- Support APM1.2
- Support ACPI2.0 power management

Mainboard PX915-SLI

Green Function:

- Support Phoenix-Award™ BIOS power management function
- System waked from power saving mode by touching keyboard or mouse

ABS (Albatron BIOS Security):

- Support ABS card (optional)
- Support BIOS backup

Hardware Monitor Function:

- Monitor CPU/ Chassis Fan Speed
- Monitor CPU and system temperature
- Monitor system voltages

Watch Dog Timer:

- This function is for detecting the system when it is unable to handle over-clocking configurations during the POST stage. Once the problem is detected, the system will reset the configurations and reboot the system within five seconds.

Mainboard PX915-SLI

Configuration Layout of PX915-SLI

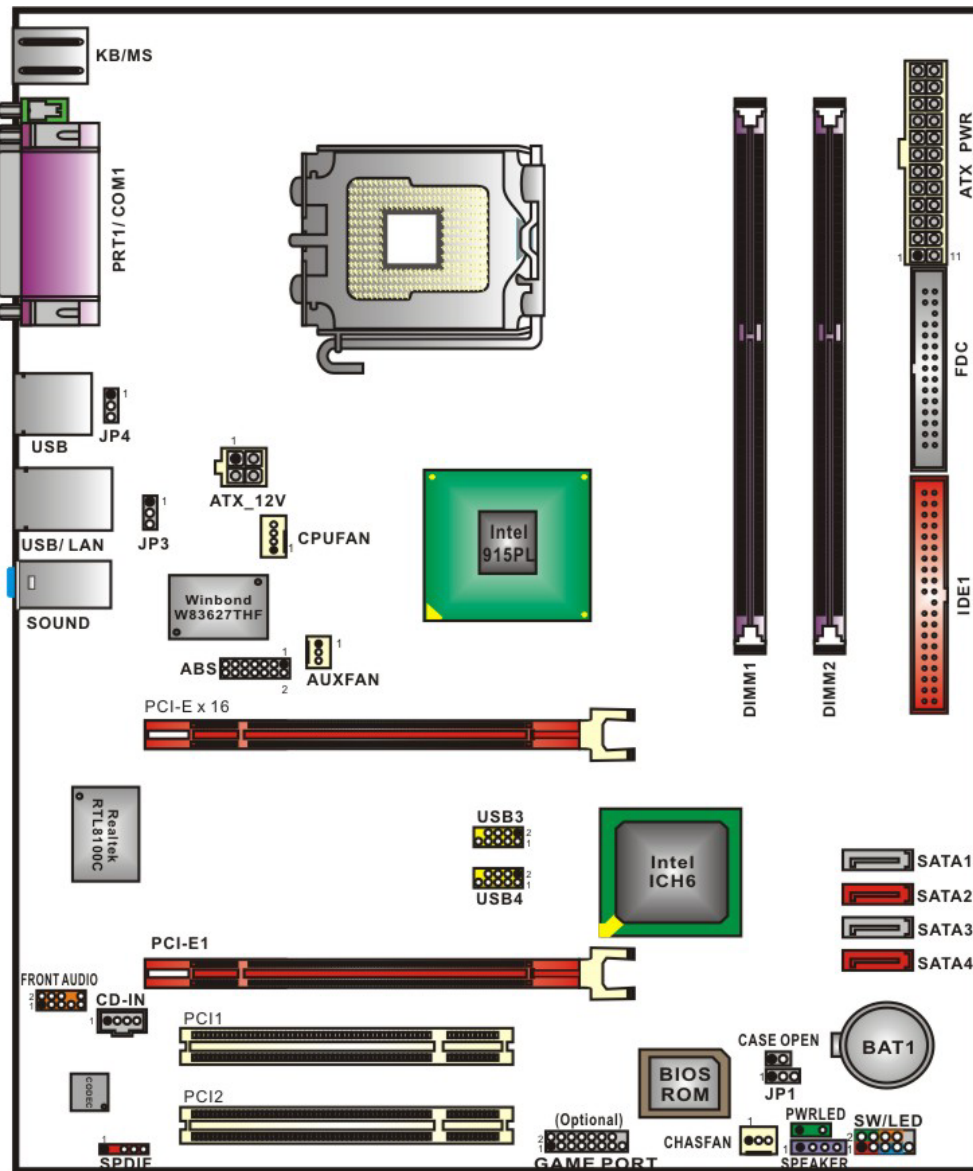

Hardware Installation

This section will assist you in quickly installing your system hardware. Wear a wrist ground strap before handling components. Electrostatic discharge may damage the system's components.

CPU Processor Installation

This mainboard supports Intel® Pentium® 4 processors using a Socket 775. Before building your system, we suggest you to visit the Intel website and review the processor installation procedures. <http://www.intel.com>

CPU Socket 775 Configuration Steps:

1. Locate the CPU socket 775 on your mainboard and nudge the lever away from the socket as shown. Then lift the lever to a 140-degree angle (A). Next, lift up the iron cover (B).

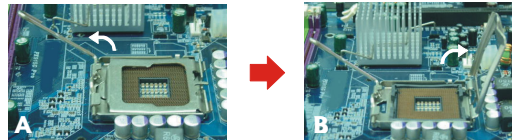

2. There are 2 distinctive marks located near the corners of the socket on the same side as the lever as shown (C). Match these marks with the marks on the CPU and carefully lower the CPU down onto the socket (D).

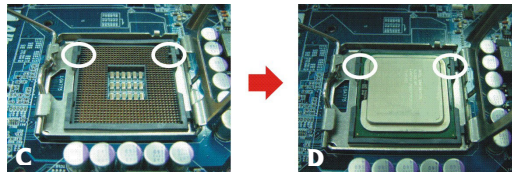

3. Replace the iron cover and then lower the lever until it snaps back into position (E). This will lock down the CPU (F).

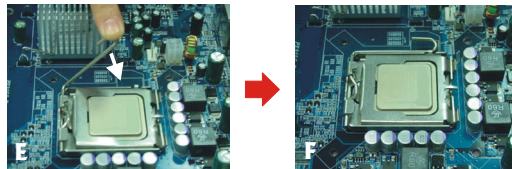

4. Smear thermal grease on the top of the CPU. Lower the CPU fan onto the CPU/CPU socket and secure it using the attachments or screws provided on the fan. Finally, attach the fan power cord to the **CPUFAN** header.

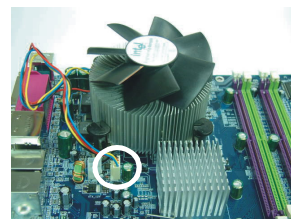

Attention: DO NOT touch the CPU pins due to they are sensitive and easily to be damaged. Make sure that you have completed all installation steps before turn on the system. Finally, double-check that the heatsink is properly installed and make sure that the CPU fan power cord is securely attached (cooling problems may cause overheating and lead to damage the CPU and other sensitive components).

Mainboard PX915-SLI

FAN Headers: CPUFAN, AUXFAN, CHASFAN

There are three fan headers available for cooling fans attached. The cooling fans are playing important roles to maintain your CPU and ambient temperatures in your system. Please attach the fan cords to these three headers.

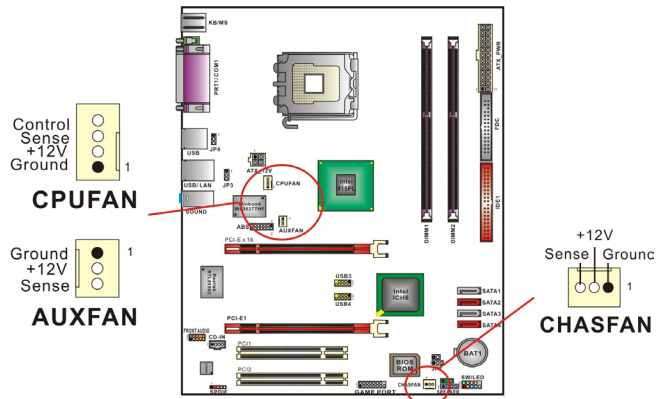

Attention: We strongly recommend you to set a cooling fan with your CPU, and attach the fan power cord to the CPUFAN header, to avoid damaging your CPU due to high temperature. In general, the black wire of fan cord is Ground and should be attached to the header pin-1.

Memory Installation: DIMM1/2

The PX915-SLI provides two DIMM (Dual In-Line Memory Module) sockets that using 184-pin DDR SDRAM with a total memory capacity of 2GB. You can insert unbuffered and non-ECC DDR400 (PC3200)/ DDR333 (2700) SDRAM with dual channel mode.

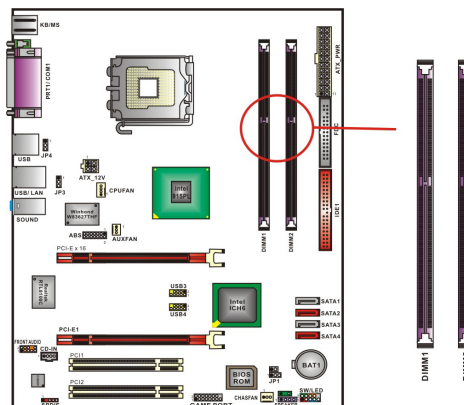

Mainboard PX915-SLI

Enable the Dual-Channel function:

This mainboard supports the Dual Channel Technology. When the Dual Channel function is activated, the bandwidth of memory bus will be doubled the original one, and you will save a lot of time on data transformation.

We strongly recommend you to install two the identical memories (i.e., same timing specifications and DDR speed) in DIMM sockets to achieve the best effects. Otherwise, different type and SPD (series presence detect) of memories installed may make the system trouble in turn-on or lower the memory speed.

Setup Steps:

1. Pull the white plastic tabs at both ends of the socket away.

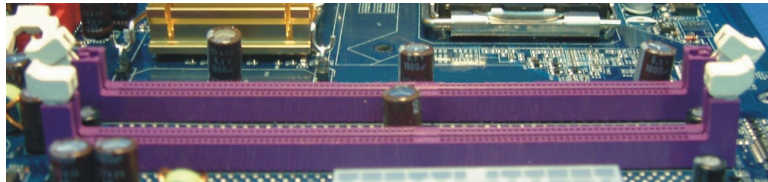

2. Align a memory on the socket such that the notch on the memory matches the break on the socket.

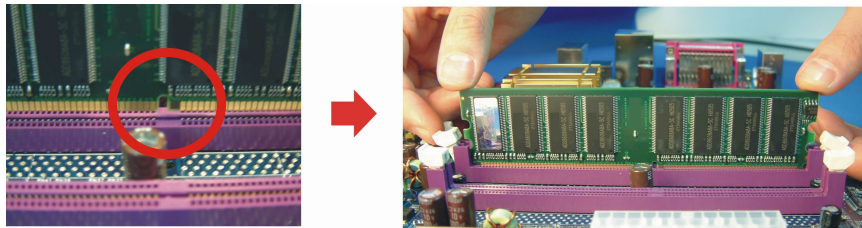

3. Lower the memory vertically into the socket and press firmly by using both thumbs until the memory snaps into place.

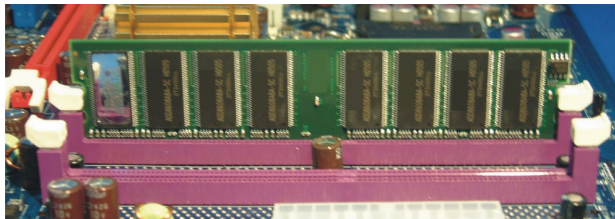

4. Repeat steps 1, 2 & 3 for the remaining memory and DIMM sockets setup.

* The pictures shown above are for reference only. Your actual installation may vary slightly from the pictures.

Mainboard PX915-SLI

Back Panel Configuration

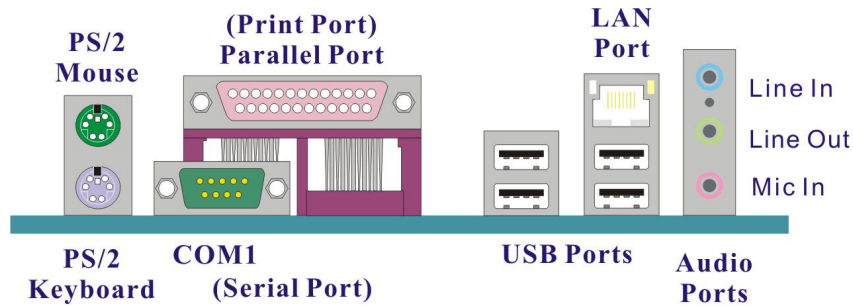

PS/2 Mouse & PS/2 Keyboard Ports: KB/MS

This mainboard provides a standard PS/2 mouse port and a PS/2 keyboard port. The pin assignments are described below.

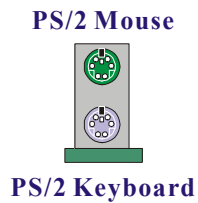

Pin	Assignment	Pin	Assignment
1	Data	4	+5 V (fused)
2	No connect	5	Clock
3	Ground	6	No connect

Serial and Parallel Interface Ports

The mainboard provides one serial port and one parallel port on the back panel.

Parallel Interface Port: PRT

The parallel port on your mainboard is a standard 25-pin one, and is used to connect a parallel printer.

The Serial Interface: COM1

This mainboard provides a serial port COM1 on your back panel, and is used to connect mice, modem and other peripheral devices. Through this port, you can also transfer data from your computer hard disk drive to other computers.

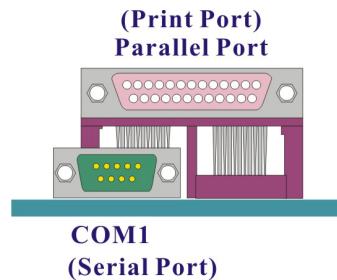

Mainboard PX915-SLI

USB & LAN Ports: USB/ LAN (GBLAN is optional)

There are four USB 2.0/ 1.1 ports on your back panel. These USB ports are used to connect with USB devices, such as keyboard, mice and other USB interface supported devices. This mainboard also provides a 10/100 Mbps (or 1Gbps) Ethernet LAN port and you can directly plug an Internet cable to this port for a network setting.

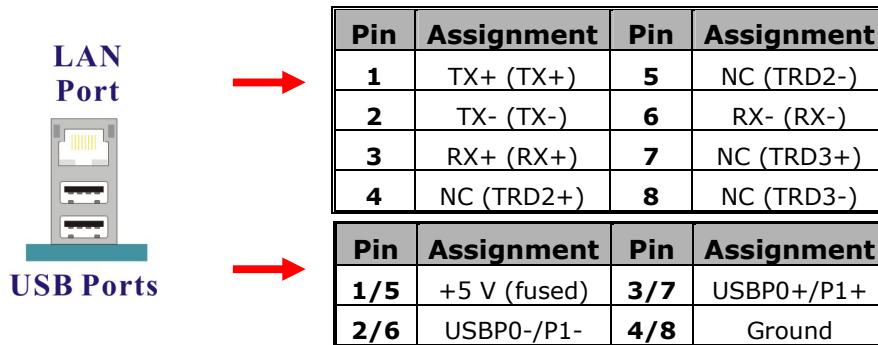

Audio Ports: Sound

This mainboard provides three audio ports, the Mic-in, Line-in and Line-out, are the standard audio ports that provide the basic audio function.

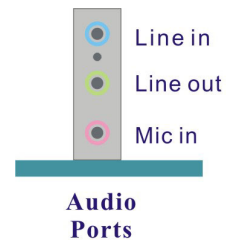

Line-In Port (Blue)

This port is for connecting an external audio device such as a CD player, tape player, and so on to output audio sounds. When the Super 5.1 Channel Audio Effect is enabled, sounds will be outputted from your rear speakers.

Line-Out Port (Green)

It is a standard audio port for connecting the speaker or headset. When the Super 5.1 Channel Audio Effect is enabled, sounds will be outputted from your front speakers.

Mic-In Port (Pink)

This port is for connecting a microphone, and you can input your voice through this port. When the Super 5.1 Channel Audio Effect is enabled, sounds will be outputted from your subwoofer/center devices.



This mainboard supports Super 5.1 Channel Audio Effect, and you can transfer 2 channel to 6 channel audio. See Appendix I for more information.

Connectors

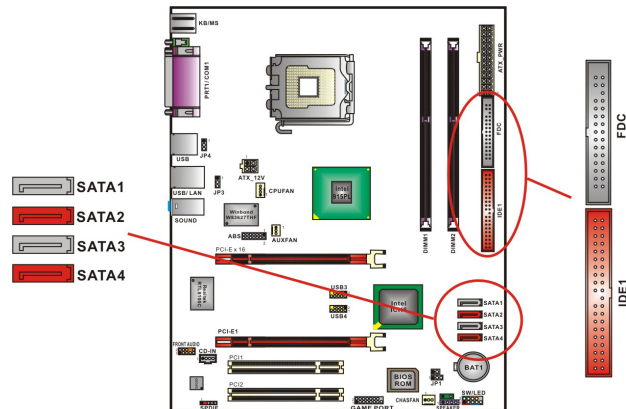

Floppy Disk Drive Connector: FDC

The mainboard provides a standard floppy disk drive connector (FDC) that supports 360K, 720K, 1.2M, 1.44M and 2.88M floppy disk drive and supports with the FDD ribbon cable.

Hard disk drive Connectors

The mainboard provides one IDE Connector that supports PIO Mode 0~4, BUS Master, Ultra ATA 66/100/133 specification, and supports four Serial ATA connectors with 150MBps transmission speeds. These connectors also support to work with the IDE cable and SATA cable (optional).

Primary IDE Connector: IDE1

There are maximal two IDE devices can be attached to this connector. If you attach two IDE hard disk drives, you must configure one as the master and the other one as the slave, so that these HDDs can be worked normally. However, the optical devices, i.e., CD-ROM, DVD-ROM...etc. should be attached to this connector as well.

Serial ATA Connector: SATA1/2/3/4

The SATA 1/2/3/4 connectors support SATA 150 Mbps transmission speeds for SATA HDDs. One SATA connector only can attach one SATA HDD of each time.

Mainboard PX915-SLI

Front Panel Headers: SW/LED、PWRLD、SPEAKER

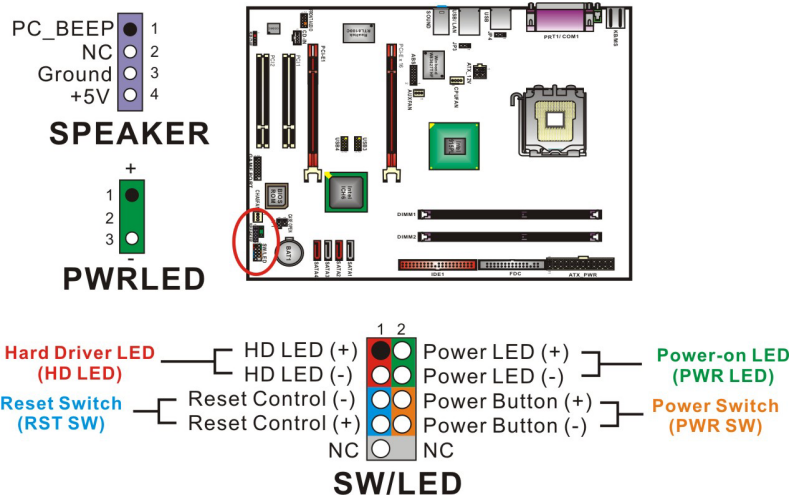

Hard Drive LED Header (Red): HD LED

If your PC front panel has a hard drive LED cord, please attach it to this header. The LED will flicker during the hard disk drive activity.

Reset Switch Header (Blue): RST SW

This header can be attached to a momentary SPST switch cord on your PC front panel. The switch is normally left open. When the switch closed, it will cause the mainboard to reset and run the POST (Power-On Self Test).

Power Switch Header (Orange): PWR SW

This header can be attached to a power switch cord on your PC front panel. You can turn on or off the system by pressing this power switch.

2-pin Power LED Header (Green): PWRLD

The mainboard provides a 2-pin power LED header. If there is a 2-pin power LED cord on your PC front panel, you can attach it to the 2-pin power LED header. The LED will be turned on as the system is powered on.

3-pin Power LED Header (Green): PWRLD

The mainboard also provides a 3-pin power LED header. If there is a 3-pin power LED cord on your PC front panel, you can attach it to this 3-pin header instead of attach to the 2-pin one on the SW/LED header.

Speaker Header (Purple): SPEAKER

A speaker cord on your PC front panel can be attached to this header. When you reboot the computer, the speaker will sound a short "beep". If there is something wrong during the Power On Self-Test, the speaker otherwise will sound "irregular beep" to warn you.

Mainboard PX915-SLI

Headers & Jumpers

Game Port Header: GAME PORT (Optional)

There is a game port header on this mainboard. To use this header, you must attach a game port bracket-cable (optional) so that you can attach related game devices.

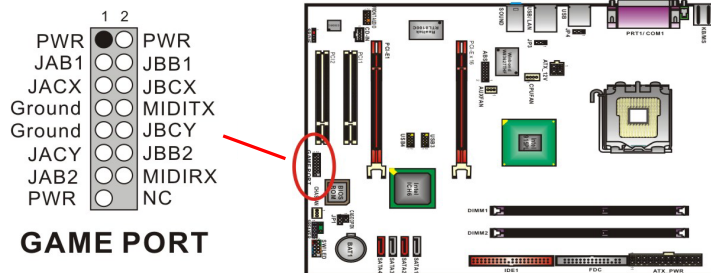

Case Open Warning Header: CASE OPEN

This header is used to warn the user when the computer case has been previously opened. To use this function, you have to enable the CASE OPEN warning function in the BIOS Setup Utility. When your computer case is opened, your system will show alert messages during the boot up. (Make sure that your computer case provides this "case open" cable.)

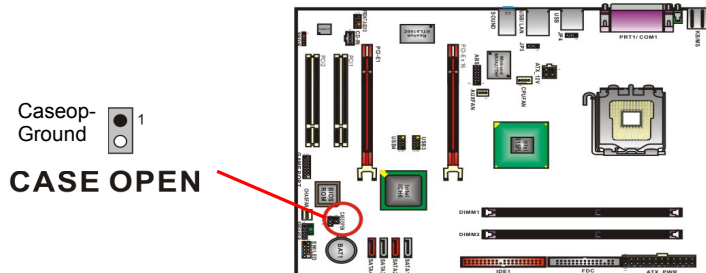

Front USB Headers: USB3/4

The mainboard provides four USB 1.1/2.0 ports for you to attach USB devices, and two USB headers provided can allow you to set more USB ports on your PC front panel. Attach a USB cable (optional) to these two headers so you can set additional four USB ports to use. You can maximal set eight USB ports to use for this mainboard.

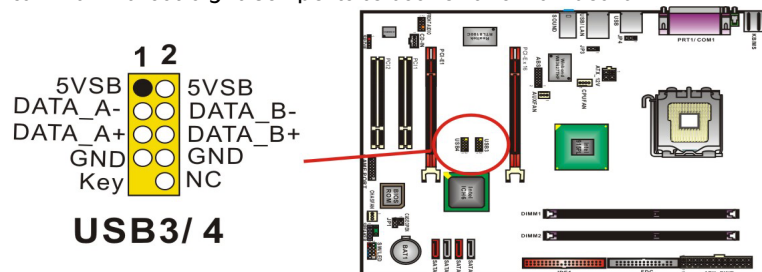

Mainboard PX915-SLI



If you are using a USB 2.0 device with Windows 2000/XP, you will need to install the USB 2.0 driver from the Microsoft® website. If you are using Service pack 1 (or later) for Windows® XP, and using Service pack 4 (or later) for Windows® 2000, you do not need to install the driver.

USB Power Headers: JP3/4

The USB power headers are including the JP3 header and JP4 header. When you need to use USB devices, please set the header jumpers to +5V.

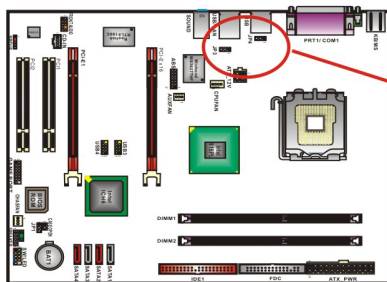

Pin1-2 Closed
↓
+5V Voltage
JP3/4



Pin2-3 Closed
↓
+5V Standby Voltage
JP3/4



(Closed stands to cover two-pins on the header using a jumper cap.)

Clear CMOS Jumper: JP1

The "Clear CMOS" function is used when you cannot boot your system due to some CMOS problems, such as a password is forgotten. This jumper allows you to reset the CMOS configurations, and then reconfigure it.

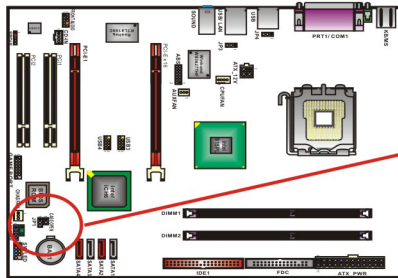

Pin1-2 Closed
↓
Normal (default)
JP1



Pin2-3 Closed
↓
Clear CMOS data
JP1



(Closed stands to cover two-pins on a header using a jumper cap.)



The following steps explain how to reset your CMOS configurations when you have forgotten your system password.

1. Turn off your system and disconnect the AC power cable.
2. Set JP1 header to OFF (2-3 Closed).
3. Wait several seconds.
4. Set JP1 header to ON (1-2 closed).
5. Connect the AC power cable and turn on your system.
6. Reset your new password.

Audio Configuration

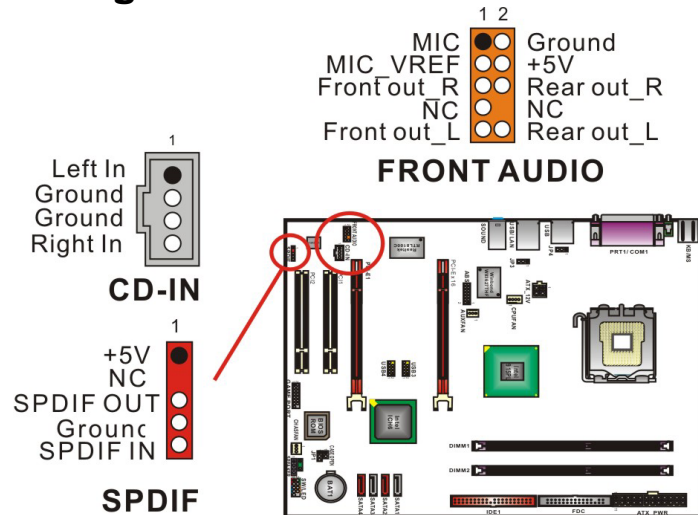

CD-ROM Audio-In Connector: CD-IN

This header is used to attach an audio cable to audio resources, such as CD-ROM, DVD-ROM...etc.

S/PDIF header: SPDIF

S/PDIF (Sony/Philips Digital Interface) is a recent audio transfer file format which provides high quality audio using optical fiber and digital signals. First, install the S/PDIF device (optional) into your PC, and attach the SPDIF wire to the mainboard SPDIF header. The SPDIF device will have onboard RCA connector or TOS-Link

connector for you attaching an audio cable to another SPDIF audio module, then the SPDIF formatted audio output will be ready. However, you must use the SPDIF supported speakers to enable the SPDIF formatted audio output and make it to be efficiency.

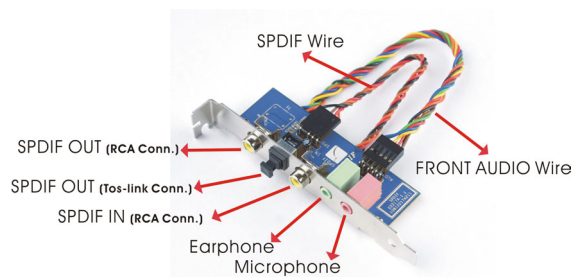

Front Audio Header: FRONT AUDIO

If your PC front panel has front audio ports, please remove the jumpers on this header, and then you can use the audio ports on both your PC front panel and back panel at the same time. On the other hand, if your PC front panel does not have the design of audio ports, please set jumpers on this header to the default location (**Note:** Jumper 1 should be on pin 5-6, and jumper cap2 should be on pin 9-10) in order to avoid your PC back panel audio ports failure.

Mainboard PX915-SLI

Slots

This mainboard provides two PCI-Express x16 slots and two PCI slots for graphics cards and expansion cards used. The expansion cards are one of ways to enhance your system efficiency.

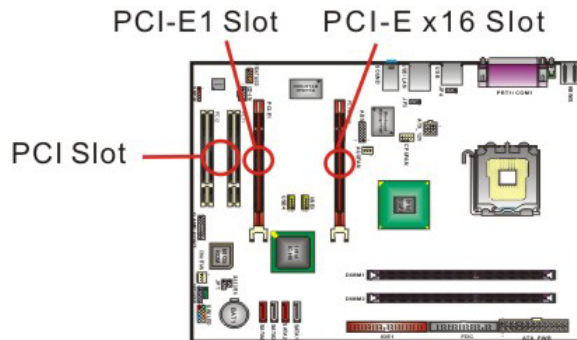

PCI-Express slots: PCI-E X16, PCI-E1

The PCI-E x16 slot and PCI-E1 slot are PCI-Express x16 interface slots, which individual can support up to 16 times and 4 times performed speeds, and support users to insert two dual graphic cards for multiple display. Via the Bridge Card setup (See Appendix II), the PCI-Express efficiency can be essentially improved .

PCI Slots: PCI1/2

This mainboard provides two standard 32-bit PCI slots. PCI stands for Peripheral Component Interconnect and is a bus standard for expansion cards, which has supplanted the older ISA bus standard.

Power Supply Attachments

ATX Power Connector: ATX PWR \ ATX 12V

This mainboard provides two power connectors, the 20-pin ATX PWR connector and the 4-pin ATX 12V connector. Through connecting with the power supply, the system is able to support several functions such as the instant power-on function, and so on. In general, the red (or other color) wires of this two power cords are Positive, and should be attached to the Positive of connectors; the black wires of this two power cords are Ground, and should be attached to the Ground of connectors.

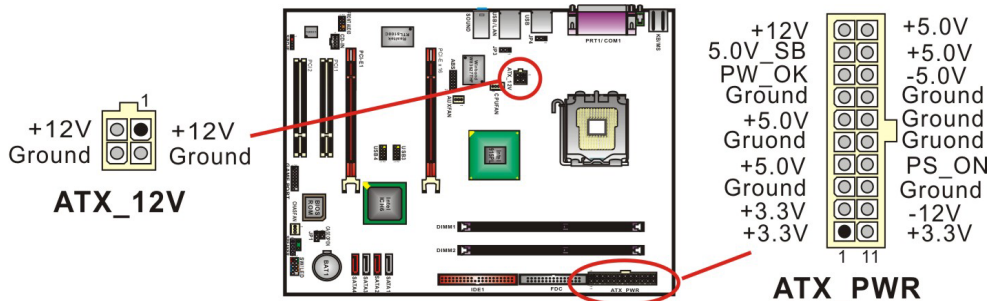

Chapter 2. BIOS Setup

Introduction

This section describes PHOENIX-AWARD™ BIOS Setup program which resides in the BIOS firmware. The Setup program allows users to modify the basic system configuration. The configuration information is then saved to CMOS RAM where the data is sustained by battery after power-down.

The BIOS provides critical low-level support for standard devices such as disk drives, serial ports and parallel ports. As well, the BIOS controls the first stage of the boot process, loading and executing the operating system.

The PHOENIX-AWARD™ BIOS installed in your computer system's ROM is a custom version of an industry standard BIOS. This means that it supports the BIOS of Intel® based processors.

This version of the PHOENIX-AWARD™ BIOS includes additional features such as virus and password protection as well as special configurations for fine-tuning the system chipset. The defaults for the BIOS values contained in this document may vary slightly with the version installed in your system.

Plug and Play Support

This PHOENIX-AWARD™ BIOS supports the Plug and Play Version 1.0A specification as well as ESCD (Extended System Configuration Data) write.

EPA Green PC Support

This PHOENIX-AWARD™ BIOS supports the Version 1.03 of EPA Green PC specification.

APM Support

This PHOENIX-AWARD™ BIOS supports the Version 1.1 & 1.2 of Advanced Power Management (APM) specification. These features include system sleep and suspend modes in addition to hard disk and monitor sleep modes. Power management features are implemented using the System Management Interrupt (SMI).

PCI/ PCI-Express Bus Support

This PHOENIX-AWARD™ BIOS also supports Version 2.3 of the Intel PCI (Peripheral Component Interconnect) local bus specification and the PCI-Express v1.0a specification.

DRAM Support

DDR (Double Data Rate) SDRAM (Synchronous DRAM) is supported.

Mainboard PX915-SLI

Supported CPUs

This PHOENIX-AWARD™ BIOS supports the Intel® Pentium® 4 CPUs.

Key Function

In general, you can use the arrow keys to highlight options, press <Enter> to select, use the <PgUp> and <PgDn> keys to change entries, press <F1> for help and press <Esc> to quit. The following table provides more detail about how to navigate within the BIOS Setup program.

Keystroke	Function
Up arrow	Move to previous option
Down arrow	Move to next option
Left arrow	Move to the option on the left (menu bar)
Right arrow	Move to the option on the right (menu bar)
Esc	Main Menu: Quit without saving changes Submenus: Exit Current page to the next higher level menu
Move Enter	Move to the option you desire
PgUp key	Increase the numeric value or enter changes
PgDn key	Decrease the numeric value or enter changes
+ Key	Increase the numeric value or enter changes
- Key	Decrease the numeric value or enter changes
Esc key	Main Menu – Quit and do not save changes into CMOS Status Page Setup Menu and Option Page Setup Menu – Exit Current page and return to Main Menu
F1 key	General help on Setup navigation keys
F5 key	Load previous values from CMOS
F6 key	Load the defaults from BIOS default table
F7 key	Load the turbo defaults
F10 key	Save all the CMOS changes and exit

Mainboard PX915-SLI

Main Menu

When you enter the PHOENIX-AWARD™ BIOS Utility, the Main Menu will appear on the screen. The Main menu allows you to select from several configuration options. Use the left/right arrow keys to select a particular configuration screen from the top menu bar or use the down arrow key to access and configure the information below.

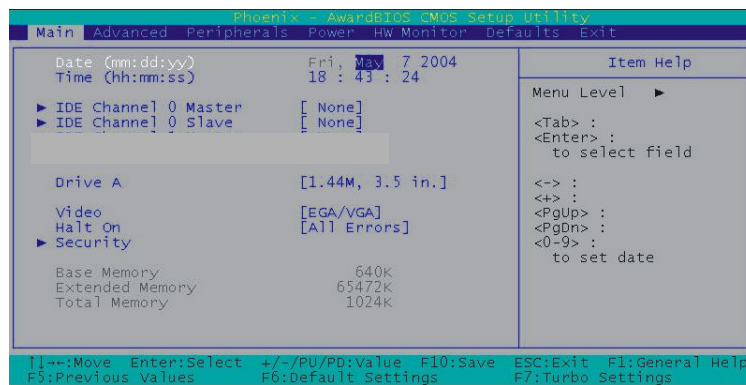

Option	Options	Description
Date	mm dd yyyy	Set the system date. Note that the 'Day' automatically changes when you set the date.
Time	Hh: mm: ss	Set the current time of the system.
IDE Channel 0 Master	Options contained in sub menu.	Press <Enter> to enter the sub menu.
IDE Channel 0 Slave	Options contained in sub menu.	Press <Enter> to enter the sub menu.
Driver A	None; 360K, 5.25 in; 1.2M, 5.25 in; 720K, 3.5 in; 1.44M, 3.5 in; 2.88M, 3.5 in	Select the type of floppy disk drive installed in your system.
Video	EGA/VGA; CGA 40; CGA 80; MONO	Select the default video device.
Halt On	All Errors; No Errors; All, but Keyboard; All, but Diskette; All, but Disk/ Key	Select the situation in which you want the BIOS to stop the POST process and notify you.
Security	Options contained in sub menu.	Press <Enter> to enter the sub menu.
Base Memory	N/A	Displays the amount of conventional memory detected during boot up.
Extended Memory	N/A	Displays the amount of extended memory detected during boot up.
Total Memory	N/A	Displays the total memory available in the system.

Advanced BIOS Features

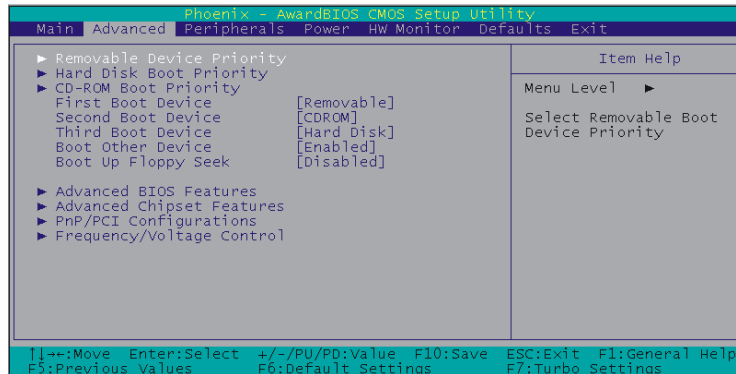

Removable Device Priority

Select removable device priority. Just like floppy, LS120, ZIP-100, USB-FDD and USB-ZIP.

Hard Disk Boot Priority

Select hard disk boot priority.

First /Second/Third Boot Device

Select the order in which devices will be searched in order to find a boot device.

Options: Removable (default for first boot device),Hard Disk (default for third boot device),CDROM (default for second boot device),Disabled

Boot Other Device

The setting allows the system to try to boot from other devices if the system fails to boot from the 1st/ 2nd/ 3rd boot devices.

Options: Enabled (default),Disabled

Boot Up Floppy Seek

When Enabled, the BIOS tests (seeks) floppy drives to determine whether they have 40 or 80 tracks. Only 360 KB floppy drives have 40 tracks. Drives with 720 KB, 1.2 MB and 1.44 MB capacity have 80 tracks. Because very few modern PCs have 40-tracks floppy drivers, we recommend that you set this option to "Disabled".

Options: Enabled,Disabled (default)

Mainboard PX915-SLI

Advanced BIOS Features

CPU Feature

Delay Prior to Thermal

Select the delay time before thermal activation from high temperatures.

Options: 4 Min,8 Min,16 Min (default),32 Min

Thermal Management

This option will monitor the CPU thermal to prevent the CPU damage with high temperature.

Limit CUID MaxVal

When the limit CUID MaxVal is set to 3, the option should be set to "Disabled" for Windows XP. Options: Enabled,Disabled (default)

Excute Disable Bit

It can prevent viruses invaded while the programmable processing.

Virus Warning

This option allows you to choose the Virus Warning feature for IDE Hard Disk boot sector protection. If this function is enabled and someone attempts to write data into thia area, BIOS will display a warning message on the screen and sound an audio alarm (beep).

Options: Disabled (default),Enabled

CPU L1 & L2 Cache

Make CPU internal cache active or inactive. System performance may degrade if you disable this option. Options: Enabled (default),Disable.

Hyper-Threading Technology

When you install a CPU include Hyper-Threading Technology. And this option will allow you to enable or disabled the Hyper-Threading technology.

Options: Disabled,Enabled (default)

Quick Power On Self Test

Allow the system to skip certain tests while booting. This will speed up the boot process.

Options: Enabled (default),Disabled.

Boot Up NumLock Status

Select the power on state for NumLock.

Options: On (default) Numpad keys are number keys.

 Off Numpad keys are arrow keys.

Mainboard PX915-SLI

Typematic Rate Setting

When the options of "Enabled", "typematic rate," and "typematic delay" can be configured, the Typematic Rate determines the keystroke repeat rate used by the keyboard controller.

Options: Disabled (default),Enabled

Typematic Rate (Chars/Sec)

The rate of a character repeated needs.

Options: 6 (default),8,10,12,15,20,24,30

Typematic Delay (Msec)

The delay values before keystrokes begin to repeat.

Options: 250 (default),500,750,1000

APIC Mode

"MPS version control for OS" must be configured if this function wants to be enabled.

Options: Disabled,Enabled (default)

MPS Version Control For OS

The 1.1 version is the older version that supports 8 more IRQs in the Windows NT environment. Choose the new 1.4 version for Windows 2000 and Windows XP.

Options: 1.4 (default),1.1

OS Select For DRAM > 64MB

Select "OS2" only if you are running the OS/2 operating system with greater than 64MB of RAM. Options: Non-OS2 (default),OS2

HDD S.M.A.R.T. Capability

The Self Monitoring Analysis and Reporting Technology is a technology that enables a PC to attempt to predict the possible failure of storage drives.

Options: Disabled (default),Enabled

Intel OSB Logo Show

This option allows you to show or hide the small LOGO EPA.

Options: Disabled,Enabled (default)

Advanced Chipset Features

DRAM Timing Selectable

This option determines DRAM clock/ timing using SPD or manual configuration.

Make sure your memory module has SPD (Serial Presence Data), if you want to select the "By SPD" option.

Options: Manual,By SPD (default)

CAS Latency Time

This option determines CAS Latency. When synchronous DRAM is installed, the number of clock cycles of CAS latency depends on the DRAM timing. Do not reset this option from the default value specified by the system engineer. This option is adjustable only when "DRAM Timing Selectable" is set to "Manual". This option is locked when "DRAM Timing Selectable" is set to "By SPD" and is automatically determined by the system.

Options: 2,2.5,3

DRAM RAS# to CAS# Delay

This option allows you to select a delay time between the CAS and RAS strobe signals. It only applies when DRAM is written to, read from, or refreshed. This option is adjustable only when "DRAM Timing Selectable" is set to "manual". This option is locked when "DRAM Timing Selectable" is set to "By SPD" and is automatically determined by the system.

Options: 4,3,2

DRAM RAS# Precharge

This option allows you to select the DRAM RAS# precharged time. The ROW address strobe must be precharged again before DRAM is refreshed. An inadequate configuration may result in incomplete data. This option is adjustable only when "DRAM Timing Selectable" is set to "manual". This option is locked when "DRAM Timing Selectable" is set to "By SPD" and is automatically determined by the system.

Options: 4,3,2

Precharge Delay

This option allows you to select DRAM Active to Precharge Delay. This option is locked when "DRAM Timing Selectable" is set to "By SPD" and is automatically determined by the system.

Options: 8,7,6,5

System BIOS Cacheable

When enabled, accesses to system BIOS ROM addressed at F0000H-FFFFFH are cached, provided that the cache controller is enabled. Options: Enabled (default), Disabled

Mainboard PX915-SLI

Video BIOS Cacheable

Select "Enabled" to allow caching of the video BIOS which may improve performance. If any other program writes to this memory area, a system error may result.

Options: Enabled, Disabled (default)

Memory Hole at 15M-16M

When enabled, you can reserve an area of system memory for ISA adapter ROM. When this area is reserved, it cannot be cached. Refer to the user documentation of the peripheral you are installing for more information.

Options: Disabled (default), Enabled

PCI Express Root Port Func

PCI Express 1 Port 1

This option allows you to enable or disable PCI Express x 1 port 1. Options: Auto (default), Disabled

PCI-E Compliancy Mode

This option allows you to select the PCI-E Compliancy Mode. Options: V1.0a (default), V1.0

PnP/PCI Configurations

Reset Configuration Data

Select "Enabled" to reset the Extended System Configuration Data (ESCD) if you have installed a new add-on card and the system reconfiguration has caused such a serious conflict that the OS cannot boot.

Options: Disabled (default), Enabled

Resources Controlled By

BIOS can automatically configure all the boot and Plug and Play compatible devices. If you choose Auto, you will not be able to manually assign IRQ DMA and memory base address options, since BIOS automatically assigns them.

Options: Auto (ESCD) (default), Manual

IRQ Resources

When resources are controlled manually, you can assign each system interrupt a type, depending on the type of device using the interrupt. This is only configurable when "Resources Controlled By" is set to "Manual".

Options: IRQ-3/ 4/ 5/ 7/ 9/ 10/ 11/ 12/ 14/ 15 assigned to PCI device

PCI / VGA Palette Snoop

Some graphic controllers that are not VGA compatible take the output from a VGA controller and map it to their display as a way to provide boot information and VGA

Mainboard PX915-SLI

compatibility.
Options: Disabled (default),Enabled

PCI Latency Timer (CLK)

This option allows you to set up the PCI Latency Time (0-255). If you select the "32" it will optimize PCI speeds.

Options: 0-255,32 (default)

PCI SLOT1/2

This option allows you to select an IRQ address for PCI slot 1/2. Options: Auto (default),3,4,5,7,9,10,11,12,14,15

****PCI Express relative Items****

Maximum payload Size

This option allows you to set the PCI Express Maximum payload size per time.

Options: 4096 (default),128,256,512,1024,2048

Frequency/Voltage Control

Spread Spectrum

The Spread Spectrum function can reduce the EMI (Electromagnetic Interference) generated. Options: Enabled (default),Disabled

PCI Speed Setting

This option determines the PCI frequency (speed settings). You can set the frequency using the supplied BIOS options. One of the options available to you is "Auto". Using the "Auto" option will instruct the system to automatically calculate the frequency.

Options: Auto (default),33.0,37.7,44.0

PCI-E Speed Setting

This option determines the PCI-E frequency (speed settings). You can set the frequency using the supplied BIOS options. One of the options available to you is "Auto". Using the "Auto" option will instruct the system to automatically calculate the frequency.

Options: Auto (default),100

System Memory Frequency

This option allows you to select Memory Frequency.

Options: Auto (default),333 MHz,400 MHz

CPU Speed Detected

This option displays the default CPU speed.

Mainboard PX915-SLI

CPU Speed Setting

This option display the CPU speed that you setting for. If you don't change the "CPU Host Frequency" or the "CPU Clock Ratio" and the option will display the current CPU speed.

CPU Host Frequency (MHz)

This option displays the CPU Host frequency. You can set it from XXX to 333. The default depends on your CPU frequency. The default for this option depends on the CPU installed.

CPU Clock Ratio

This option is display only if the CPU has not been set to a locked state by the CPU manufactory. If your CPU is locked, you will not be able to adjust the "CPU Clock Ratio". The default depends on your CPU.

DDR Voltage (Volt)

This option allows you to adjust the RAM voltage.

Options: Default (default), + 0.3V, + 0.2V, + 0.1V

NB Voltage (Volt)

This option allows you to adjust the North Bridge voltage.

Options: Default (default), +0.3V, + 0.2V, + 0.1V

Default CPU Voltage (Volt)

This option displays the CPU default Voltage.

CPU Voltage (Volt)

This option allows you to adjust your CPU core voltage.

Options: 0.85 ~ 1.9 (The default depends on your CPU.)

Peripherals

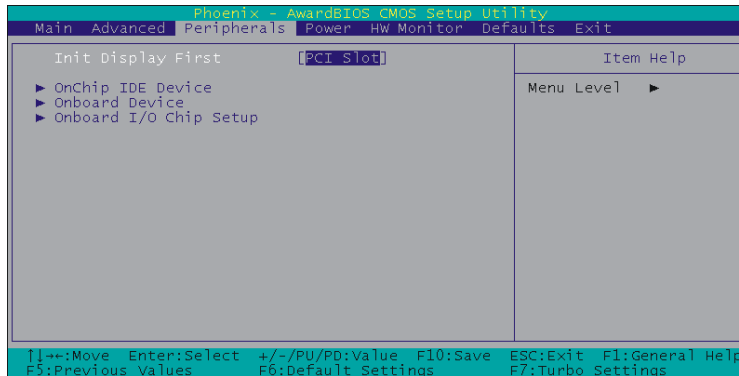

Init Display First

With systems that have multiple video cards, this option determines whether the primary display uses a PCI slot or an AGP slot. Options: PCIEx (default), PCI Slot

OnChip IDE Device

IDE HDD Block Mode

Block mode is otherwise known as block transfer, multiple commands, or multiple sector read/write. Select the "Enabled" option if your IDE hard drive supports block mode (most new drives do). The system will automatically determine the optimal number of blocks to read and write per sector. Options: Enabled (default), Disabled

On-chip channel0/channel1 PCI IDE

The mainboard chipset contains a PCI IDE interface with support for two IDE channels. These two IDE channels are for IDE1 and SATA1/2/3/4 connectors use. Select "Enabled" to activate the first and/or second IDE interface. Select "Disabled" to deactivate the interface if you are going to install a primary and/or secondary add-in IDE interface. Options: Enabled (default), Disabled

IDE channel0/ channel1/Master/Slave PIO

The IDE PIO (Programmed Input / Output) options let you set a PIO mode (0-4) for each of the IDE devices that the onboard IDE interface supports. Modes 0 to 4 will increase performance incrementally. In Auto mode, the system automatically determines the best mode for each device. Options: Auto (default), Mode0, Mode1, Mode2, Mode3, Mode4.

Mainboard PX915-SLI

IDE channel0 /channel1 /Master / Slave UDMA

Ultra DMA 100 functionality can be implemented if it is supported by the IDE hard drives in your system. As well, your operating environment requires a DMA driver (Windows 95 OSR2 or a third party IDE bus master driver). If your hard drive and your system software both support Ultra DMA 100, select "Auto" to enable BIOS support.

Options: Auto (default),Disabled

***** OnChip Serial ATA Setting*****

On-Chip Serial ATA

This option allows you to select the on-chip Serial ATA operating mode which will determine how you will use your Serial ATA drives with the other standard IDE drives. This system can physically attach 2 IDE drives and 4 SATA drives but will have certain limitations as described below.

Options:

Disabled Disable on-chip serial ATA. No Serial ATA devices installed.

Auto(default) BIOS will auto-detect the presence of any SATA devices.

2 (or 1) IDE drivers + 4 (or 3) SATA drivers → Enhanced Mode

2 (or 1) IDE drivers + 2 (or 1) SATA drivers (Must connect with SATA1 + 3 or with SATA2 + 4)
→ Combined Mode

4 (or 3 or 2 or 1)SATA drivers → SATA only

2 (or 1) IDE drivers → Disabled

Combined Mode Windows® 98/ME can recognize IDE devices but cannot directly recognize an SATA device and therefore you must use this mode to allow the SATA device to simulate an IDE device by assuming the role of one IDE channel in the system. This means that you will have one available IDE channel for 2 SATA drives to use (each IDE channel can support 2 IDE drives). If you were to install all both IDE drives and 4 SATA drives, you will only see 2 of the SATA drives along with the 2 IDE drives.

Enhanced Mode In this mode, you can use all 6 hard disk drives (including 2 IDE drives and 4 SATA drives).

Note: You cannot use "Enhanced" mode with Windows® 98/ME. It only support to install Windows® 2000/ XP if you want to boot from SATA device. (It's restriction from Microsoft.)

SATA Only Select this option when you install SATA drives only.

PATA IDE Mode

This option allows you to select an IDE channel for PATA IDE devices. When you install the SATA device(s) to the SATA1 or 3 or 1 + 3, this option should be set to channel 1. When you install the device(s) to the SATA2 or 4 or 2 + 4, this option should be set to channel 0.

Options: Channel 0 (default),channel 1

SATA Port

This option will display which IDE channel will be used to the SATA device.

Options: SATA2, 4 is channel 1

Mainboard PX915-SLI

Onboard Device

USB Controller

This option should be enabled if your system has a USB port installed on the system board. You will need to disable this feature if you add a higher performance controller.

Options: Enabled (default),Disabled

USB 2.0 Controller

This option should be enabled if your system has a USB 2.0 device installed on the system board. You will need to disable this feature if you install a USB 1.1 device.

Options: Enabled (default),Disabled

USB Keyboard Support

Enables support for USB attached keyboards. Options: Disabled (default),Enabled

Audio Device

This option allows you to control the onboard audio. Options: Auto (default),Disabled

Onboard I/O Chip Setup

Power On Function

This option allows you to select a way to power on your computer.

Options: Password,Hot KEY,Mouse Left,Mouse Right,Any KEY,BUTTON ONLY (default), and Keyboard 98

KB Power-On Password

This option is as a part of power-on sequences with your system. This option is configurable only when "Power-On Function" is set with "Password".

Hot Key Power ON

This option allows you to use the Ctrl key along with a hot key (function key) to power on your system. This option is configurable only when "Power-On Function" is set to "Hot Key". Options: Ctrl-F1,Ctrl-F2..... Ctrl-F12

Onboard FDC Controller

Select "Enabled" if your system has a floppy disk controller (FDC) installed on the system board and you wish to use it. If you install an add-in FDC or the system has no floppy drive, select "Disabled". Options: Enabled (default),Disabled

Onboard Serial Port 1

Select an address and corresponding interrupt for the first/ second serial port.

Mainboard PX915-SLI

Options: Disabled,3F8/IRQ4 (default for port1),2F8/IRQ3,3E8/IRQ4,2E8/IRQ3,Auto

UART Mode Select

This option allows you to select the Infra Red (IR) standard to be used.

Options: Disabled (default),IrDA

RxD, TxD Active

This option determines the RxD and TxD frequencies. This option is configurable only if "UART Mode Select" is set to "IrDA".

Options: Hi / Lo (default),Hi / Hi,Lo / Hi,Lo / Lo

IR Transmission Delay

This option allows you to enable/disable IR transmission delay. This option is configurable only if "UART Mode Select" is set to "IrDA".

Options: Enabled (default),Disabled

UR2 Duplex Mode

Select the transmission mode used by the IR interface. Full-duplex mode permits simultaneous bi-directional transmission. Half-duplex mode permits transmission in only one direction at a time. This option is configurable only if "UART Mode Select" is set to "IrDA". Options: Half (default),Full

Use IR Pins

Consult your IR peripheral documentation to select the correct setting of the TxD and RxD signals. This option is configurable only if "UART Mode Select" is set to "IrDA".

Options: IR-Rx2Tx2(default),RxD2,TxD2

Onboard Parallel Port

Select an address and corresponding interrupt for the onboard parallel port.

Options: 378/IRQ7 (default),278/IRQ5,3BC/IRQ7,Disabled

Parallel Port Mode

This option allows you to select a parallel port mode for the onboard parallel port.

Options:

ECP (default) Extended Capabilities Port.

EPP Enhanced Parallel Port.

SPP Standard Printer Port.

ECP + EPP ECP & EPP mode.

Normal

Mainboard PX915-SLI

EPP Mode Select

Select EPP port type 1.7 or 1.9. This option is configurable only if "Parallel Port Mode" is set to "EPP" or "ECP + EPP". Options: EPP 1.9(default),EPP 1.7

ECP Mode Use DMA

Select a DMA Channel for the parallel port when using the ECP mode. This option is configurable only if "Parallel Port Mode" is set to "ECP".

Options: 3 (default),1

PWRON After PWR-Fail

This option will determine whether your system will boot after restoring power after a power failure. If you select "On", the system will boot whether or not the system was on before power failure. If you select "Former-Sts", the system will be restored to the status before the power failure.

Options: Off (default),On,Former-Sts

Game Port Address

Game port I/O address. Options: 201(default),Disabled,209

Midi Port Address

Midi port Base I/O address. Options: Enabled(default),Disabled

Midi Port IRQ

This option determines the IRQ that the Midi Port will use. Options: 10(default),5

Power Management

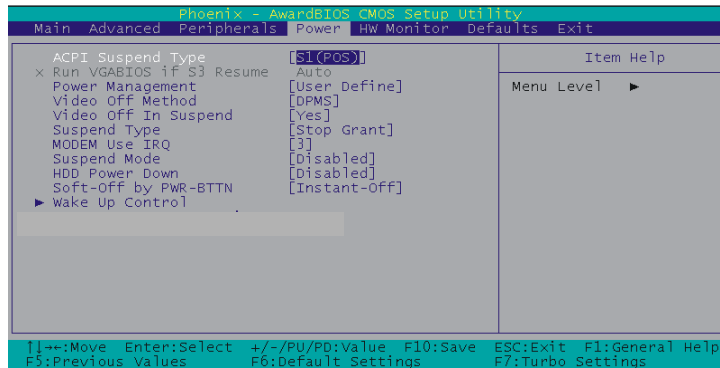

The Power Management Setup Menu allows you to configure your system to utilize energy conservation features as well as power-up/ power-down options.

ACPI Suspend Type

The option allows you to select the suspend type using the ACPI operating system.

Options:

- S1 (POS) (default) Power on Suspend
- S3 (STR) Suspend to RAM
- S1 & S3 POS and STR

Run VGABIOS if S3 Resume

Select whether you want to run VGABIOS when the system wakes up from the S3 suspend function. This option is not configurable if "ACPI Suspend Type" is set to "S1(POS)".

Options: Auto (default),Yes,No

Power Management

There are three options of Power Management:

1. Min. Saving

Minimum power management

Suspend Mode = 1hour

HDD Power Down = 15 minutes

2. Max. Saving

Maximum power management (only available for sl CPUs).

Suspend Mode = 1 minute

HDD Power Down = 1 minute

Mainboard PX915-SLI

3. User Defined (default)

This option allows you to set each mode individually.

When this option is enabled, each of the ranges are from 1 minute to 1 hour except for HDD Power Down, which ranges from 1 minute to 15 minute and includes a "disable" option.

Note: If you select Min. or Max. Power Saving modes, the "HDD Power Down" value and the "Suspend Mode" value are both fixed.

Video Off Method

This option determines the manner in which the monitor goes blank.

Options:

V/H SYNC + Blank This selection will cause the system to turn off the vertical and horizontal synchronization ports and write blanks to the video buffer.

Blank Screen(default) This option only writes blanks to the video buffer.

DPMS Support Initial display power management signaling.

Video Off In Suspend

This determines whether power to the monitor is switched off when the computer is in suspend mode.

Options: Yes,No (default)

Suspend Type

This option allows you to select the suspend type under the ACPI operating system.

Options: Stop Grant (default),PwrOn Suspend

Modem Use IRQ

This determines the modem's IRQ. Options: 3 (default),4,5,7,9,10,11,NA.

Suspend Mode

This option allows you to select the suspend time under the ACPI operating system.

Options: Disabled(default),1Min,2Min,4Min,8Min,12Min,20Min,30Min,40Min,1Hour

HDD Power Down

When enabled, the hard disk drive will power down after a certain configurable period of system inactivity. All other devices remain active.

Options: Disabled (default),1 Min,2 Min,3 Min,4 Min,5 Min,6 Min,7 Min,8 Min,9 Min,10 Min,11 Min,12 Min,13 Min,14 Min,15Min

Mainboard PX915-SLI

Soft-Off by PWRBTN

In situations where the system enters a "hung" state, you can configure the BIOS so that you are required to pre the power button for more than 4 seconds before the system enters the Soft-Off state.

Options: Delay 4 Sec, Instant-Off (default).

Wake Up Control

If you highlight the "Wake Up Control" label and then press the enter key, it will display a submenu with the following options:

PCI PME Wake Up

This option will also cause the system to wake up with any onboard LAN activity.

Options: Disabled (default),Enabled

Ring Wake Up

This option allows you to awaken the system upon receiving an incoming call to modem device. Options: Disabled (default),Enabled.

USB KB Wake-up From S3

This option allows you to awaken the system from suspend mode using a USB keyboard.

Options: Enabled,Disabled (default)

* This option is configurable only when the ACPI Suspend Type is set to S3.

RTC Wake Up

When "Enabled", you can set the date and time at which the RTC (real-time clock) alarm awakens the system from Suspend mode. Options: Enabled,Disabled (default).

Date (of Month) Alarm

You can choose which date of the month the system will boot up. This option is configurable only when "RTC Wake Up" is set to "Enabled".

Time (hh: mm: ss) Alarm

You can choose the hour, minute and second the system will boot up. This option is configurable only when "RTC Wake Up" is set to "Enabled".

****Reload Global Timer Events****

When a system goes into suspend mode, certain devices must be inactive for a period of time. Conversely, if any of those devices have any activity, the system will awaken. You can select the devices that will participate in suspend/power-on activity by configuring these options. Devices include: Primary IDE 0/ Primary IDE 1/ Secondary IDE 0/ Secondary IDE 1/ FDD,COM,LPT Port/ PCI PIRQ [A-D]#. Options: Disabled (default), Enabled

Hardware Monitor

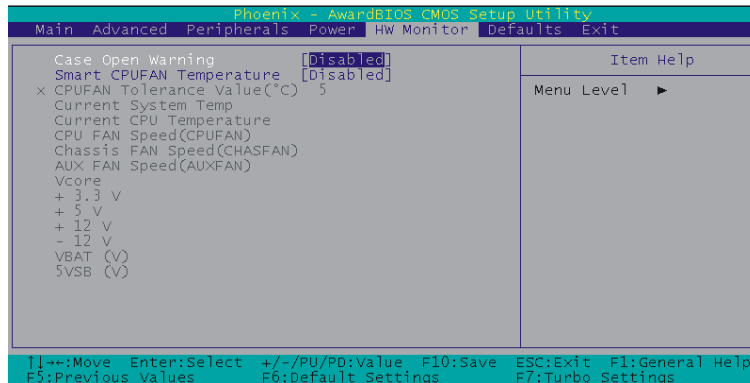

Case Open Warning

If this option is set to "Enabled" and the case had been previously opened, the system will automatically display alert messages on the screen when you power on your computer. If this is set to "Disabled", the system will not show alert messages when you power on your computer even if the case had been previously opened.

Options: Disabled (default),Enabled

Smart CPUFAN Temperature

This option allows you to select the CPU temperature. If the CPU temperature is higher than the value you've selected, the CPUFAN will accelerate till the temperature cools down to the defaulted value you set.

Options: Disabled (default),30°C / 86°F,35°C / 95°F,40°C / 104°F,45°C / 113°F,50°C / 122°F,55°C / 131°F,60°C / 140°F,65°C / 149°F,70°C / 158°F,75°C / 167°F,80°C / 176°F,85°C / 185°F

Defaults

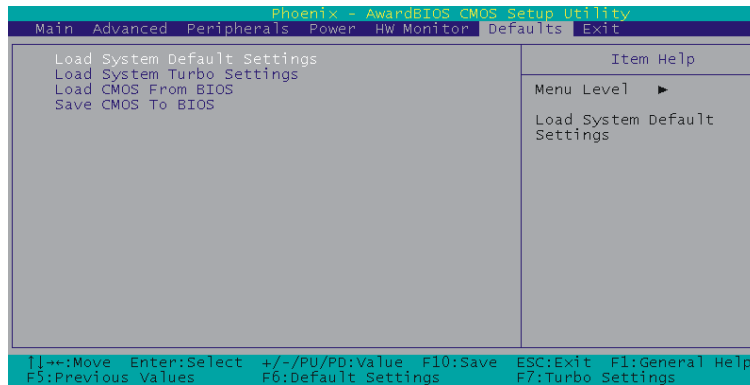

Load System Default Settings

Load System Default Settings.

Load System Turbo Settings

Load System Turbo Settings.

Load CMOS From BIOS

Load defaults from flash ROM for systems without batteries.

Save CMOS To BIOS

Save defaults to flash ROM for systems without batteries.

Exit Menu

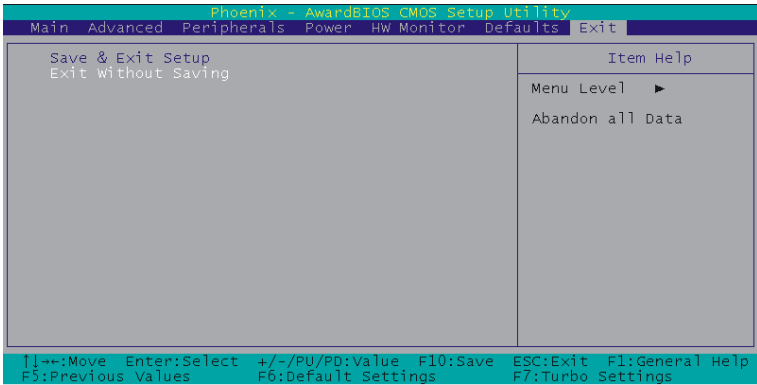

Save & Exit Setup

Save all configuration changes to CMOS (memory) and exit setup. A confirmation message will be displayed before proceeding.

Exit Without Saving

Abandon all changes made during the current session and exit setup. A confirmation message will be displayed before proceeding.

Chapter 3: Software Setup

Software List

Category	Platform
Intel Chipset INF	Windows 2000 /XP
Realtek AC' 97 Audio Driver	Windows 2000 /XP
Realtek Network Driver	Windows 98 /ME /2000 /XP
Trend PC-Cillin 2005	Windows 98 /ME /2000 /XP
Microsoft DirectX9.0c	Windows 98 /ME /2000 /XP
Adobe Acrobat Reader 5	Windows 98 /ME /2000 /XP

Note: Due to the Intel Chipset INF and Realtek AC'97 Audio Driver do not support Windows® 98/ ME, we strongly recommend you to use Windows® 2000/ XP as operating system for this mainboard.

Software Installation

Place the Driver CD into the CD-ROM drive and the Installation Utility will auto-run. You can also launch the Driver CD Installation Utility manually by executing the Intel.exe program located on the Driver CD. (For more details, please refer to the Readme.txt files that in each folder of the Driver.)

© The screen and images are only for general reference. The version of the screens you received with your software may vary slightly.

1. When you insert the driver CD into the CD ROM, you'll see the screen as the picture below. There are several buttons displayed in the main screen as shown below.

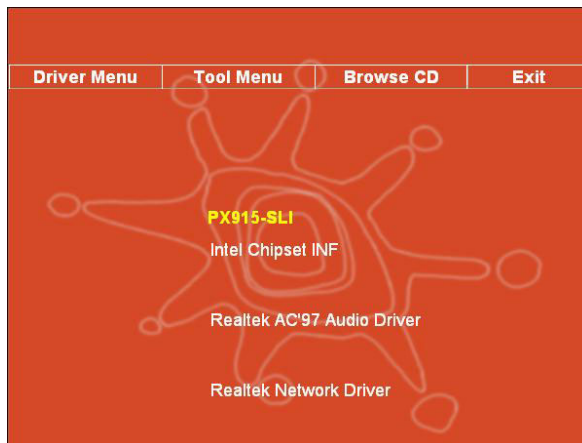

Mainboard PX915-SLI

- Intel Chipset INF – It provides all drivers for the functions which built in both the Northbridge/ Southbridge
- Realtek AC'97 Audio Driver – It provides the driver of Realtek AC'97 Audio Codec
- Realtek Network Driver – It provides the driver of Realtek Network

2. Click the "Utilities" and you can choose the software to install.

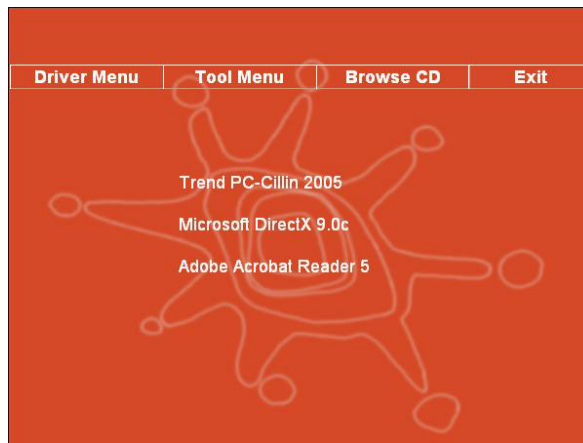

- Trend PC-Cillin 2005 – It provides the software of Trend PC-Cillin 2005 (Anti-virus program)
- Microsoft DirectX9.0c – It provides the software of Microsoft DirectX9.0c
- Adobe Acrobat Reader5 – Installing the Adobe Acrobat Reader program, you can browse files with pdf styled

3. If you click the "Browse CD" button from the screen in step 1, you can browse all the files in the Driver CD.

4. Click "Exit" button to exit the program.

Chapter 4: Troubleshooting

Problem 1:

No power to the system. Power light does not illuminate. Fan inside power supply does not turn on. Indicator lights on keyboard are not lit.

Causes:

1. Power cable is unplugged.
2. Defective power cable.
3. Power supply failure.
4. Faulty wall outlet; circuit breaker or fuse blown.

Solutions:

1. Make sure power cable is securely plugged in.
2. Replace cable.
3. Contact technical support.
4. Use different socket, repair outlet, reset circuit breaker or replace fuse.

Problem 2:

System inoperative. Keyboard lights are on, power indicator lights are lit, hard drive is active but system seems "hung"

Causes: Memory DIMM is partially dislodged from the slot on the mainboard.

Solutions:

1. Power Down
2. Using even pressure on both ends of the DIMM, press down firmly until the module snaps into place.

Problem 3:

System does not boot from the hard disk drive but can be booted from the CD-ROM drive.

Causes:

1. Connector between hard drive and system board unplugged.
2. Damaged hard disk or disk controller.
3. Hard disk directory or FAT is corrupted.

Solutions:

1. Check the cable running from the disk to the disk controller board. Make sure both ends are securely attached. Check the drive type in the standard CMOS setup.
2. Contact technical support.
3. Backing up the hard drive is extremely important. Make sure you periodically perform backups to avoid untimely disk crashes.



Mainboard PX915-SLI

Problem 4:

System only boots from the CD-ROM. The hard disk can be read and applications can be used but booting from the hard disk is impossible.

Causes: Hard Disk boot sector has been corrupted.

Solutions: Back up data and applications files. Reformat the hard drive. Re-install applications and data using backup disks.

Problem 5:

Error message reading "SECTOR NOT FOUND" displays and the system does not allow certain data to be accessed.

Causes: There are many reasons for this such as virus intrusion or disk failure.

Solutions: Back up any salvageable data. Then performs low level format, partition, and then a high level format the hard drive. Re-install all saved data when completed.

Problem 6:

Screen message says "Invalid Configuration" or "CMOS Failure."

Causes: Incorrect information entered into the BIOS setup program.

Solutions: Review system's equipment. Reconfigure the system.

Problem 7:

The Screen is blank.

Causes: No power to monitor.

Solutions: Check the power connectors to the monitor and to the system.

Problem 8:

Blank screen.

Causes:

1. Memory problem.
2. Computer virus.

Solutions:

1. Reboot computer. Reinstall memory. Make sure that all memory modules are securely installed.
2. Use anti-virus programs to detect and clean viruses.

Problem 9:

Screen goes blank periodically.

Causes: Screen saver is enabled.

Solutions: Disable screen saver.



Mainboard PX915-SLI

Problem 10:

Keyboard failure.

Causes: Keyboard is disconnected.

Solutions: Reconnect keyboard. Replace keyboard if you continue to experience problems.

Problem 11:

No color on screen.

Causes:

1. Faulty Monitor.
2. CMOS incorrectly set up.

Solutions:

1. If possible, connect monitor to another system. If no color appears, replace monitor.
2. Call technical support.

Problem 12:

The screen displays "C: drive failure."

Causes: Hard drive cable not connected properly.

Solutions: Check hard drive cable.

Problem 13:

Cannot boot the system after installing a second hard drive.

Causes:

1. Master/slave jumpers not set correctly.
2. Hard drives are not compatible / different manufacturers.

Solutions:

1. Set master/slave jumpers correctly.
2. Run SETUP program and select the correct drive types. Call drive manufacturers for possible compatibility problems with other drives.

Problem 14:

Missing operating system on hard drive.

Causes: CMOS setup has been changed.

Solutions: Run setup and select the correct drive type.

Problem 15:

Certain keys do not function.

Causes: Keys jammed or defective.

Solutions: Replace keyboard.



Appendix I: Super 5.1 Channel Audio Effect Setup

Channels Setup

1. After getting into the system, click the audio icon  from the Windows screen.
2. Click Speaker Configuration button, you can see the screen like the picture below.
3. You can choose 2, 4 or 6 channels by your speakers.

2 Channels

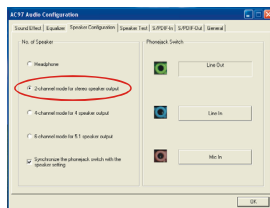

4 Channels

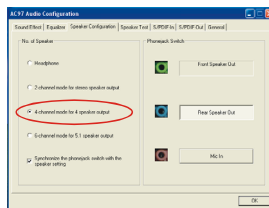

6 Channels

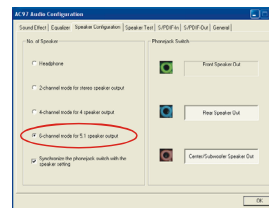

Super 5.1 Channel Audio Effect

This mainboard comes with an ALC655 Codec which supports high quality 5.1 Channel audio effects. With ALC655, you are able to use standard line-jacks for surround audio output without connecting to any auxiliary external modules. To use this function, you have to install the audio driver in the bonus Pack CD as well as an audio application supporting 5.1 Channel audio effects. See the audio Port Connectors in the Hardware Installation section for a description of the output connectors.

Speaker Test

Make sure the cable is firmly into the connector.

1. Click the audio icon  from the Windows screen.
2. Click Speaker Test button, you can see the screen like the pictures below.
3. Select the speaker which you want to test by clicking on it.

2 Channels



4 Channels



6 Channels

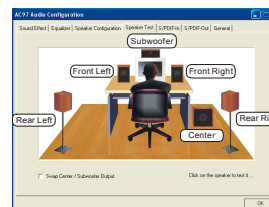

Appendix II: Bridge Card Setup

Introduction

Through inserting two dual graphic cards on the mainboard and setting the graphic cards' software installation, users then can review and process their tasks on four separated monitors at the same time, and further to improve their working efficiency. In addition, via the Bridge Card setup, the improved PCI-Express bandwidth can make users to utilize PCI-E efforts in more efficient ways.

Setup Steps

1. Insert two dual graphic cards onto the mainboard PCI-E x16 slots. Detailed explanation of hardware installation, please refer your graphic card's User Manual.
2. Insert two end slots of the Bridge Card onto the golden fingers of two dual graphic cards top edge, the Bridge Card then will be settled done. At mean while, we recommend you to attach the monitor cable to the D-Sub or DVI connector of your first inserted graphic card (which is located on the mainboard PCI-E x16 slot) for monitor display.

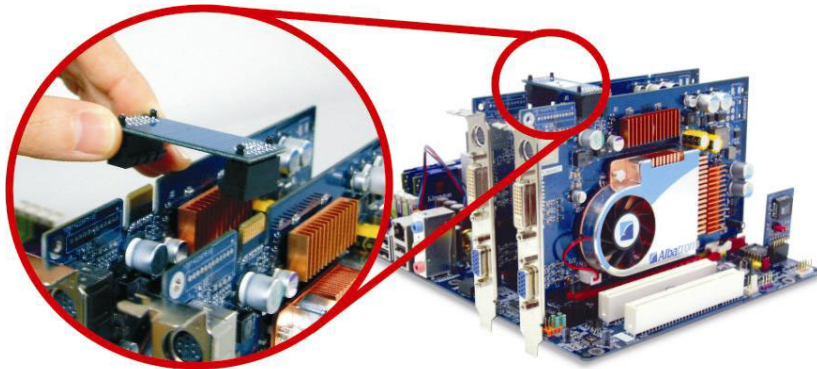

Attention

1. Window XP is the recommended operating system.
2. It is recommended for you to use two identical dual graphic cards, i.e., same brand and same specification.
3. Detailed explanation of software installation, please refer your graphic card's User Manual. (We recommend you to stall the version 71.84g driver by downloading from websites.)
4. The exact power requirement will depend on needs of your overall system configuration and two dual graphic cards. (We recommend you to set power supply at $\geq 400W$ and +12V current at $\geq 25A$.)

Appendix III: ABS (Albatron BIOS Security) Card Setup

Introduction

The ABS (Albatron BIOS Security) function will provide your BIOS a backup, even when your onboard BIOS is damaged and to cause the system unpowered. You can just insert an ABS card (optional) onto the mainboard ABS header, and through setting the card jumpers, the enabled ABS function will assist you to recover your onboard BIOS.

Setup Steps

Please follow the steps below to correct use ABS card lest you damage the card or mainboard by using the improper way.

1. Remove the jumpers on the mainboard ABS header (**See Figure1**), and insert the ABS card (optional) on it. Set the card ABS_JP1 header jumpers to the location of "Rescue BIOS" (**See Figure2**).
2. Power on the system and put the BIOS recovering floppy disk or CD into your driver, your system will be powered on due to the rescue BIOS is enabled.
3. When the screen shows the DOS, remember set the card ABS_JP1 header jumpers to the location of "Onboard BIOS" firstly (**See Figure2**). After adjusting the card jumpers, start to process the BIOS recovering procedure, the data then will be saved into your onboard BIOS for recovering.
4. When you are done the BIOS recovering process, remove the ABS card while the system is shut down, and put the jumpers back on the mainboard ABS header (**See Figure1**) with default location (**Note**: The jumper 1 should be on the pin1-2, and jumper 2 should be on the pin 3-4).
5. When you second time power on the system, your onboard BIOS should successful be recovered.



Attention

1. You can also choose not to remove the ABS card when you are done the BIOS recovering process, but remember to put the card ABS_JP1 header jumpers back to the location of "Onboard BIOS" (**See Figure2**), in case the ABS card rescue BIOS will be damaged.
2. If you **do not** plan to use the ABS card, we recommend you to put the mainboard ABS header jumpers (**See Figure1**) back to the default location (Note: The jumper 1 should be on the pin1-2, and jumper 2 should be on the pin 3-4). If you **do** plan to use the ABS card, please avoid to remove the card ABS_JP1 header jumpers (**See Figure2**). Otherwise, your system may not be powered on, also your ABS card and mainboard may be damaged.
3. If both of your onboard BIOS and rescue BIOS are damaged, the ABS card will lose the function of recovering the BIOS. Hence, it is recommend you to recover the onboard BIOS first, and use the ABS card when accidents happened.

Mainboard PX915-SLI

