

Certificate HK07/01191.00

SGS

The management system of

**ELITEGROUP COMPUTER
SYSTEMS CO., LTD.
ECS MANUFACTURING
(SHENZHEN) CO., LTD.**

2F, No.240, Sec.1, Nei Hu Road, Taipei, Taiwan 114, R.O.C
No.20 & No.26 (Except 1F, 2F&3F) Free Trade Zone, Shatoujiao,
Shenzhen City, Guangdong Province, China
has been assessed and certified as meeting the requirements of



ISO 9001:2000

For the following activities

**Design and Sales of Mainboards, Personal Computers,
Notebooks, and Peripheral Cards;
Design and Manufacturing of Mainboards and Peripheral Cards.**

Further clarifications regarding the scope of this certificate and the applicability of
ISO 9001:2000 requirements may be obtained by consulting the organization
This certificate is valid from 16 March 2007 until 15 March 2010
Issue 1. Certified with SGS since March 2007

Multiple certificates have been issued for this scope
The main certificate is numbered HK07/01191.00

Authorised by

P. Earl



SGS United Kingdom Ltd Systems & Services Certification
Rossmore Business Park Eresmore Port Cheshire CH65 3EN UK
t+44 (0)151 350-6666 f+44 (0)151 350-6600 www.sgs.com

Page 1 of 1



www.sgs.com



Certificate No. **PRC-HSPM-1172**
Issued: July 10, 2007
Revision: N/A
Expiration: July 09, 2010

IECQ Certificate of Hazardous Substance Process Management (HSPM) applicable to the European Directive 2002/95/EC ("RoHS") requirements.

The Supervising Inspectorate (SGS-CSTC Standards Technical Services Co., Ltd.), sponsored by the United States National Authorized Institution, ECCB certify that

ECS Manufacturing (Shenzhen) Co., Ltd.

No. 20 & 26 (except 1F, 2F & 3F),
Free Trade Zone, Shatoujiao,
Shenzhen, Guangdong Province, P.R. China

Has developed and implemented Hazardous Substances Process Management, procedures, and related processes in compliance with the applicable requirements for HSPM organization approval which is in accordance with the Basic Rules IECQ-01 and Rules of Procedure QC 001002-3 "IECQ Hazardous Substance Process Management" of the IEC Quality Assessment System for Electronic Components (IECQ), and with respect to the Specification QC 080000 IECQ HSPM.

This certification is applicable to all electronic components and related materials and processes for the

Design and manufacture of Mainboards and Peripheral Cards.

Issued by Certification Authorities:



Electronic Component Certification Board

Signed:

Stanley H. Salot Jr. - President, ECCB
ECCB
PO Box 9041
Midland, Texas 79708
Tel: (432) 697-9970 Fax: (866) 260-6181
Web Site: www.eccb.org



SGS-CSTC Standards Technical Services Co., Ltd
16F Century YuHui Mansion
73 Fucheng Road
Beijing, China
Web Site: www.sgs.com

The validity of this certificate is maintained through on-going surveillance inspections.

Note: This certificate is valid only in conjunction with the approval document(s). This approval and this certificate may be suspended or withdrawn in accordance with the Rules of Procedure of the IECQ. This certificate remains the property of the body which granted it.

Preface

Copyright

This publication, including all photographs, illustrations and software, is protected under international copyright laws, with all rights reserved. Neither this manual, nor any of the material contained herein, may be reproduced without written consent of the author.

Version 2.0A

Disclaimer

The information in this document is subject to change without notice. The manufacturer makes no representations or warranties with respect to the contents hereof and specifically disclaims any implied warranties of merchantability or fitness for any particular purpose. The manufacturer reserves the right to revise this publication and to make changes from time to time in the content hereof without obligation of the manufacturer to notify any person of such revision or changes.

Trademark Recognition

Microsoft, MS-DOS and Windows are registered trademarks of Microsoft Corp.

nVIDIA is a registered trademark of nVIDIA Corporation

Other product names used in this manual are the properties of their respective owners and are acknowledged.

Federal Communications Commission (FCC)

This equipment has been tested and found to comply with the limits for a Class B digital device, pursuant to Part 15 of the FCC Rules. These limits are designed to provide reasonable protection against harmful interference in a residential installation. This equipment generates, uses, and can radiate radio frequency energy and, if not installed and used in accordance with the instructions, may cause harmful interference to radio communications. However, there is no guarantee that interference will not occur in a particular installation. If this equipment does cause harmful interference to radio or television reception, which can be determined by turning the equipment off and on, the user is encouraged to try to correct the interference by one or more of the following measures:

- Reorient or relocate the receiving antenna
- Increase the separation between the equipment and the receiver
- Connect the equipment onto an outlet on a circuit different from that to which the receiver is connected
- Consult the dealer or an experienced radio/TV technician for help

Shielded interconnect cables and a shielded AC power cable must be employed with this equipment to ensure compliance with the pertinent RF emission limits governing this device. Changes or modifications not expressly approved by the system's manufacturer could void the user's authority to operate the equipment.

Preface

Declaration of Conformity

This device complies with part 15 of the FCC rules. Operation is subject to the following conditions:

- This device may not cause harmful interference, and
- This device must accept any interference received, including interference that may cause undesired operation





Canadian Department of Communications

This class B digital apparatus meets all requirements of the Canadian Interference-causing Equipment Regulations.

Cet appareil numérique de la classe B respecte toutes les exigences du Règlement sur le matériel brouilleur du Canada.

About the Manual

The manual consists of the following:

Chapter 1 Introducing the Motherboard	Describes features of the motherboard. Go to  page 1
Chapter 2 Installing the Motherboard	Describes installation of motherboard components. Go to  page 7
Chapter 3 Using BIOS	Provides information on using the BIOS Setup Utility. Go to  page 27
Chapter 4 Using the Motherboard Software	Describes the motherboard software Go to  page 49
Chapter 5 Setting Up NVIDIA RAID Configuration	Provides information about SATA RAID Setup Go to  page 55

Preface

TABLE OF CONTENTS

Preface	i
Chapter 1	1
Introducing the Motherboard	1
Introduction.....	1
Feature.....	2
Motherboard Components.....	4
Chapter 2	7
Installing the Motherboard	7
Safety Precautions.....	7
Choosing a Computer Case.....	7
Installing the Motherboard in a Case.....	7
Checking Jumper Settings.....	8
<i>Setting Jumpers.....</i>	<i>8</i>
<i>Checking Jumper Settings.....</i>	<i>9</i>
<i>Jumper Settings.....</i>	<i>9</i>
Connecting Case Components.....	10
<i>Front Panel Header.....</i>	<i>12</i>
Installing Hardware.....	13
<i>Installing the Processor.....</i>	<i>13</i>
<i>Installing Memory Modules.....</i>	<i>15</i>
<i>Installing a Hard Disk Drive/CD-ROM/SATA Hard Drive...18</i>	<i>18</i>
<i>Installing a Floppy Diskette Drive.....</i>	<i>19</i>
<i>Installing Add-on Cards.....</i>	<i>20</i>
<i>Connecting Optional Devices.....</i>	<i>22</i>
Connecting I/O Devices.....	25
Chapter 3	27
Using BIOS	27
About the Setup Utility.....	27
<i>The Standard Configuration.....</i>	<i>27</i>
<i>Entering the Setup Utility.....</i>	<i>27</i>
<i>Updating the BIOS.....</i>	<i>29</i>
Using BIOS.....	29
<i>Standard CMOS Feature.....</i>	<i>30</i>
<i>Advanced BIOS Feature.....</i>	<i>32</i>
<i>Advanced Chipset Feature.....</i>	<i>36</i>

<i>Integrated Peripherals</i>	39
<i>Power Management Setup</i>	43
<i>PNP/PCI Configurations</i>	44
<i>PC Health Status</i>	45
<i>Load Fail-Safe Defaults</i>	46
<i>Load Optimized Defaults</i>	46
<i>Set Supervisor/User Password</i>	47
<i>Save & Exit Setup</i>	47
<i>Exit Without Saving</i>	47

Chapter 4 **49**

Using the Motherboard Software **49**

About the Software CD-ROM.....	49
Auto-installing under Windows 2000/XP/Vista.....	49
<i>Running Setup</i>	50
Manual Installation.....	54
Utility Software Reference.....	54

Chapter 5 **55**

Setting Up NVIDIA RAID Configuration **55**

Setting Up a Non-Bootable RAID Array.....	55
Setting Up a Bootable RAID Array.....	58

Chapter 1

Introducing the Motherboard

Introduction

Thank you for choosing the GeForce6100PM-M2 motherboard. This motherboard is a high performance, enhanced function motherboard that supports socket for AMD Phenom™ processor (socket AM2+)/AMD Athlon™ 64 X2 Dual-Core/Athlon™ 64/Sempron™ processors for high-end business or personal desktop markets.

This motherboard is based on NVIDIA® MCP61 Premium media and communications processor (MCP) for best desktop platform solution. MCP61P is a single-chip, highly integrated, high performance HyperTransport peripheral controller, unmatched by any other single chip-device controller. The memory controller supports DDR2 memory DIMM frequencies of 800/667/533/400. It supports two DDR2 sockets with maximum memory size of 16 GB. High resolution graphics via one PCI Express x16 slot, one PCI Express x1 slot, 10 USB 2.0 ports (4 USB ports and 3 USB 2.0 headers support additional 6 USB ports) and SATA support with RAID function.

There is an advanced full set of I/O ports in the rear panel, including PS/2 mouse and keyboard connectors, COM1, LPT, VGA1, four USB ports, one LAN port and audio jacks for microphone, line-in and 6/8-channel (optional) line-out. This motherboard is designed in a Micro ATX form factor using a four-layer printed circuit board and measures 244 mm x 214 mm.



Due to the DRAM maximum size is 4 GB at present, the memory maximum size we have tested is 8 GB.

Introducing the Motherboard

Feature

Processor

This motherboard uses a socket AM2+/AM2 that carries the following features:

- Accommodates AMD Phenom™ processor (socket AM2+)
- AMD Athlon™ 64 X2 Dual-Core/Athlon™ 64/Sempron™ processors
- Supports up to 2000 MT/s HyperTransport™ (HT) interface Speeds

HyperTransport™ Technology is a point-to-point link between two devices, it enables integrated circuits to exchange information at much higher speeds than currently available interconnect technologies.

Chipset

The NVIDIA® MCP61P is a single-chip with proven reliability and performance.

- 1 GHz HyperTransport x16 up and down links to the AMD socket AM2+/AM2 CPUs
- PCI Express 16 lane link interface for external graphics processors
- PCI v2.3 interface at 33 MHz
- Integrated SATA 3.0 Gb/s Host Controller
- Ten USB 2.0 ports supported
- Fast ATA-133 IDE controller

Memory

- DDR2 800/667/533/400 DDR2 SDRAM with Dual Channel supported
- Accommodates two unbuffered DIMMs
- Up to 8 GB per DIMM with maximum memory size up to 16 GB

Audio (optional)

The onboard Audio provides the following features:

<ul style="list-style-type: none"> • 7.1+2 Channel High Definition Audio Codec • All DACs support 192K/96K/48K/44.1KHz DAC sample rate • Software selectable 2.5V/3.75V VREFOUT • Meets Microsoft WHQL/WLP 2.x audio requirements • Direct Sound 3D™ compatible
<ul style="list-style-type: none"> • 7.1 Channel High Definition Audio Codec • ADC support 48K/96K sample rate • High quality differential CD input • Power Support: Digital: 3.3V; Analog: 5.0V • Meets Microsoft WHQL/WLP 2.0 audio requirements • Direct Sound 3D™ compatible
<ul style="list-style-type: none"> • 5.1 Channel High Definition Audio Codec • ADCs support 44.1/48k/96k sample rate • Meets Microsoft WHQL/WLP 3.0x audio requirements • Direct Sound 3D™ compatible
<ul style="list-style-type: none"> • 5.1 Channel High Definition Audio Codec • ADCs support 44.1/48k/96k sample rate • Meets Microsoft WLP 3.08 Vista premium and mobile PCs audio requirements • Direct Sound 3D™ compatible

Introducing the Motherboard

Onboard LAN

The onboard LAN provides the following features:

- 10BASE-T/100BASE-TX IEEE 802.3u fast Ethernet transceiver
- Low-power mode
- MII and 7-wire serial interface

Expansion Options

The motherboard comes with the following expansion options:

- One PCI Express x16 slot for Graphics Interface
- One PCI Express x1 slot
- Two 32-bit PCI v2.3 compliant slots
- One IDE connector supporting up to two IDE devices
- One floppy disk drive interface
- Four 7-pin SATA connectors

This motherboard supports Ultra DMA bus mastering with transfer rates of 133/100/66/33 Mb/s.

Integrated I/O

The motherboard has a full set of I/O ports and connectors:

- Two PS/2 ports for mouse and keyboard
- One parallel port
- One serial port
- One VGA port
- Four USB ports
- One LAN port
- Audio jacks for microphone, line-in and 6/8-channel (optional) line-out

BIOS Firmware

The motherboard uses Phoenix-Award Workstation BIOS that enables users to configure many system features including the following:

- Power management
- Wake-up alarms
- CPU parameters
- CPU and memory timing

The firmware can also be used to set parameters for different processor clock speeds.



1. Some hardware specifications and software items are subject to change without prior notice.

2. Due to chipset limitation, we recommend that motherboard be operated in the ambience between 0 to 50 °C.

Introducing the Motherboard

Motherboard Components

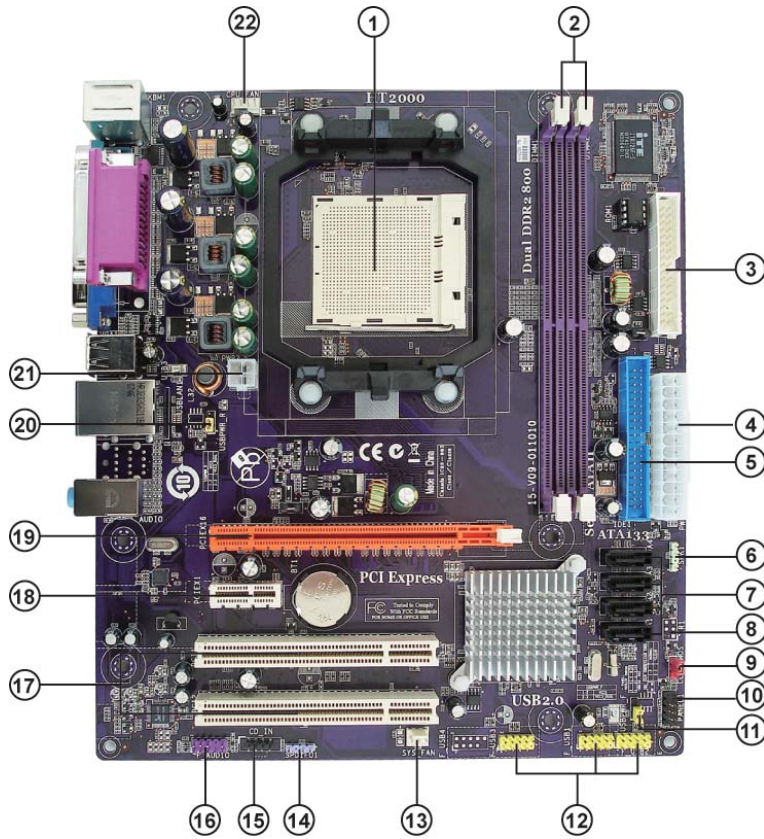

Introducing the Motherboard

Table of Motherboard Components

LABEL	COMPONENTS
1. CPU Socket	Socket for AMD Phenom™ processor (socket AM2+)/AMD Athlon™ 64 X2 Dual-Core/Athlon™ 64/Sempron™ processors
2. DIMM1~2	240-pin DDR2 SDRAM slots
3. FDD	Floppy disk drive connector
4. PWR1	Standard 24-Pin ATX Power connector
5. IDE1	Primary IDE connector
6. SPK1	Speaker header
7. SATA1~4	Serial ATA connectors
8. IRI *	Infrared header
9. CLR_CMOS	Clear CMOS jumper
10. PANEL1	Front Panel Switch/LED header
11. USBPWR_F	Front Panel USB Power Select jumper
12. F_USB1~3	Front Panel USB headers
13. SYS_FAN	System cooling fan connector
14. SPDIF01	SPDIF out header
15. CD_IN	Analog Audio Input header
16. F_AUDIO	Front Panel Audio header
17. PCI1~2	32-bit add-on card slots
18. PCIEX1	PCI Express x1 slot
19. PCIEX16	PCI Express x16 graphics card slot
20. USBPWR_R	Rear USB/PS2 Power Select jumper
21. PWR2	4-pin +12V power connector
22. CPU_FAN	CPU cooling fan connector

* stands for optional components

This concludes Chapter 1. The next chapter explains how to install the motherboard.

Introducing the Motherboard

6

Memo

Introducing the Motherboard

Chapter 2

Installing the Motherboard

Safety Precautions

- Follow these safety precautions when installing the motherboard
- Wear a grounding strap attached to a grounded device to avoid damage from static electricity
- Discharge static electricity by touching the metal case of a safely grounded object before working on the motherboard
- Leave components in the static-proof bags they came in
- Hold all circuit boards by the edges. Do not bend circuit boards

Choosing a Computer Case

There are many types of computer cases on the market. The motherboard complies with the specifications for the Micro ATX system case. Firstly, some features on the motherboard are implemented by cabling connectors on the motherboard to indicators and switches on the system case. Make sure that your case supports all the features required. Secondly, this motherboard supports one or two floppy diskette drives and two enhanced IDE drives. Make sure that your case has sufficient power and space for all drives that you intend to install.

Most cases have a choice of I/O templates in the rear panel. Make sure that the I/O template in the case matches the I/O ports installed on the rear edge of the motherboard.

This motherboard carries an Micro ATX form factor of 244 x 214 mm. Choose a case that accommodates this form factor.

Installing the Motherboard in a Case

Refer to the following illustration and instructions for installing the motherboard in a case.

Most system cases have mounting brackets installed in the case, which correspond the holes in the motherboard. Place the motherboard over the mounting brackets and secure the motherboard onto the mounting brackets with screws.

Ensure that your case has an I/O template that supports the I/O ports and expansion slots on your motherboard.

Installing the Motherboard

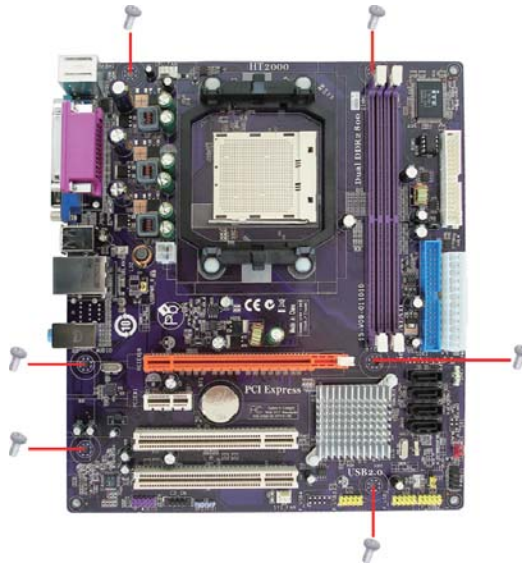

Do not over-tighten the screws as this can stress the motherboard.

Checking Jumper Settings

This section explains how to set jumpers for correct configuration of the motherboard.

Setting Jumpers

Use the motherboard jumpers to set system configuration options. Jumpers with more than one pin are numbered. When setting the jumpers, ensure that the jumper caps are placed on the correct pins.

The illustrations show a 2-pin jumper. When the jumper cap is placed on both pins, the jumper is **SHORT**. If you remove the jumper cap, or place the jumper cap on just one pin, the jumper is **OPEN**.



SHORT



OPEN

This illustration shows a 3-pin jumper. Pins 1 and 2 are **SHORT**.

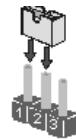



Installing the Motherboard

Checking Jumper Settings

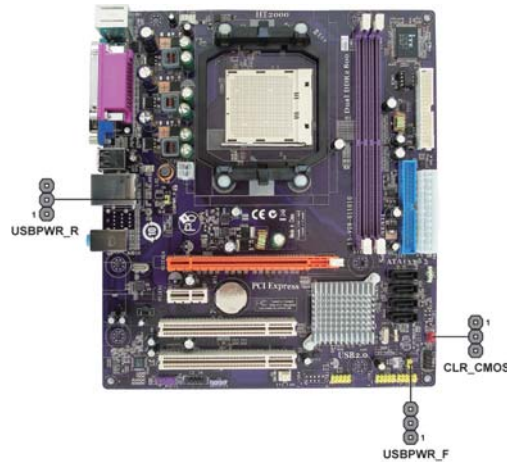
The following illustration shows the location of the motherboard jumpers. Pin 1 is labeled.



Jumper Settings

Jumper	Type	Description	Setting (default)	
CLR_CMOS	3-pin	CLEAR CMOS	1-2: NORMAL 2-3: CLEAR Before clearing the CMOS, make sure to turn the system off.	 CLR_CMOS
USBPWR_R	3-pin	Rear USB/PS2 Power Select Jumper	1-2: VCC5 2-3: VCC5_DUAL	 USBPWR_R
USBPWR_F	3-pin	Front Panel USB Power Select Jumper	1-2: VCC5 2-3: VCC5_DUAL	 USBPWR_F



1. To avoid the system instability after clearing CMOS, we recommend users to enter the main BIOS setting page to "Load Optimized Defaults" and then "Save & Exit Setup".
2. Make sure the power supply provides enough VCC5_DUAL voltage before selecting the VCC5_DUAL function.
3. It is required that users place the USBPWR_F & USBPWR_R cap onto 2-3 pin rather than 1-2 pin as default if you want to wake up the computer by USB/PS2 KB/Mouse.

Installing the Motherboard

Connecting Case Components

After you have installed the motherboard into a case, you can begin connecting the motherboard components. Refer to the following:

- 1 Connect the CPU cooling fan cable to **CPU_FAN**.
- 2 Connect the system cooling fan connector to **SYS_FAN**.
- 3 Connect the standard power supply connector to **PWR1**.
- 4 Connect the auxiliary case power supply connector to **PWR2**.
- 5 Connect the case switches and indicator LEDs to the **PANEL1**.
- 6 Connect the case speaker cable to **SPK1**.

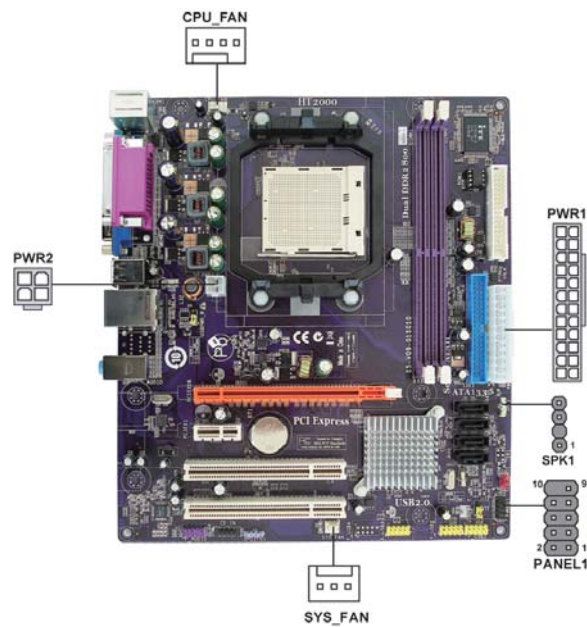

Connecting 24-pin power cable

Users please note that the 24-pin power cable can be connected to the PWR1 connector.

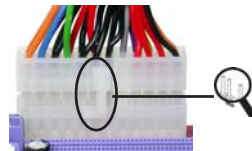

24-pin power cable

With ATX v2.x power supply, users please note that when installing 24-pin power cable, the latches of power cable and the PWR1 match perfectly.

Installing the Motherboard

CPU_FAN: FAN Power Connector

Pin	Signal Name	Function
1	GND	System Ground
2	+12V	Power +12V
3	Sense	Sensor
4	Control	CPU FAN control



Users please note that the fan connector supports the CPU cooling fan of 1.1A ~ 2.2A (26.4W max) at +12V.

SYS_FAN: System Cooling FAN Power Connector

Pin	Signal Name	Function
1	GND	System Ground
2	+12V	Power +12V
3	Sense	Sensor

PWR1: ATX 24-pin Power Connector

Pin	Signal Name	Pin	Signal Name
1	+3.3V	13	+3.3V
2	+3.3V	14	-12V
3	Ground	15	Ground
4	+5V	16	PS_ON
5	Ground	17	Ground
6	+5V	18	Ground
7	Ground	19	Ground
8	PWRGD	20	-5V
9	+5VSB	21	+5V
10	+12V	22	+5V
11	+12V	23	+5V
12	+3.3V	24	Ground

PWR2: ATX 12V Power Connector

Pin	Signal Name
1	Ground
2	Ground
3	+12V
4	+12V

Installing the Motherboard

SPK1: Internal speaker header

Pin	Signal Name
1	VCC
2	Key
3	GND
4	Signal

Front Panel Header

The front panel header (PANEL1) provides a standard set of switch and LED headers commonly found on ATX or Micro ATX cases. Refer to the table below for information:

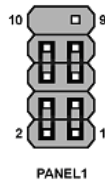

Pin	Signal	Function	Pin	Signal	Function
1	HD_LED_P	Hard disk LED (+)	2	FP PWR/SLP	*MSG LED (+)
3	HD_LED_N	Hard disk LED (-)	4	FP PWR/SLP	*MSG LED (-)
5	RST_SW_N	Reset Switch (-)	6	PWR_SW_P	Power Switch (+)
7	RST_SW_P	Reset Switch (+)	8	PWR_SW_N	Power Switch (-)
9	RSVD	Reserved	10	Key	No pin

* MSG LED (dual color or single color)

Hard Drive Activity LED

Connecting pins 1 and 3 to a front panel mounted LED provides visual indication that data is being read from or written to the hard drive. For the LED to function properly, an IDE drive should be connected to the onboard IDE interface. The LED will also show activity for devices connected to the SCSI (hard drive activity LED) connector.

Power/Sleep/Message waiting LED

Connecting pins 2 and 4 to a single or dual-color, front panel mounted LED provides power on/off, sleep, and message waiting indication.

Reset Switch

Supporting the reset function requires connecting pin 5 and 7 to a momentary-contact switch that is normally open. When the switch is closed, the board resets and runs POST.

Installing the Motherboard

Power Switch

Supporting the power on/off function requires connecting pins 6 and 8 to a momentary-contact switch that is normally open. The switch should maintain contact for at least 50 ms to signal the power supply to switch on or off. The time requirement is due to internal de-bounce circuitry. After receiving a power on/off signal, at least two seconds elapses before the power supply recognizes another on/off signal.

Installing Hardware

Installing the Processor



Caution: When installing a CPU heatsink and cooling fan make sure that you DO NOT scratch the motherboard or any of the surface-mount resistors with the clip of the cooling fan. If the clip of the cooling fan scrapes across the motherboard, you may cause serious damage to the motherboard or its components.

On most motherboards, there are small surface-mount resistors near the processor socket, which may be damaged if the cooling fan is carelessly installed.

Avoid using cooling fans with sharp edges on the fan casing and the clips. Also, install the cooling fan in a well-lit work area so that you can clearly see the motherboard and processor socket.

Before installing the Processor

This motherboard automatically determines the CPU clock frequency and system bus frequency for the processor. You may be able to change these settings by making changes to jumpers on the motherboard, or changing the settings in the system Setup Utility. We strongly recommend that you do not over-clock processors or other components to run faster than their rated speed.



Warning: Over-clocking components can adversely affect the reliability of the system and introduce errors into your system. Over-clocking can permanently damage the motherboard by generating excess heat in components that are run beyond the rated limits.

This motherboard has a socket AM2+/AM2 processor socket. When choosing a processor, consider the performance requirements of the system. Performance is based on the processor design, the clock speed and system bus frequency of the processor, and the quantity of internal cache memory and external cache memory.

Installing the Motherboard

CPU Installation Procedure

The following illustration shows CPU installation components.

- 1 Unhook the locking lever of the CPU socket. Pull the locking lever away from the socket and raising it to the upright position.
- 2 Match the pin1 corner marked as the beveled edge on the CPU with the pin1 corner on the socket. Insert the CPU into the socket. Do not use force.
- 3 Push the locking lever down and hook it under the latch on the edge of socket.
- 4 Apply thermal grease to the top of the CPU.
- 5 Install the cooling fan/heatsink unit onto the CPU, and secure them all onto the socket base.
- 6 Plug the CPU fan power cable into the CPU fan connector (CPU_FAN) on the motherboard.

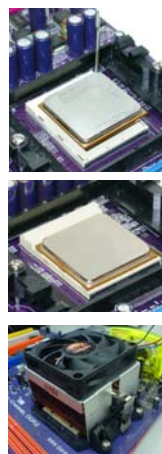

To achieve better airflow rates and heat dissipation, we suggest that you use a high quality fan with 4800 rpm at least. CPU fan and heatsink installation procedures may vary with the type of CPU fan/heatsink supplied. The form and size of fan/heatsink may also vary.

Installing the Motherboard

Installing Memory Modules

This motherboard accommodates two 240-pin unbuffered DIMMs and supports DDR2 800/667/533/400 DDR2 SDRAM. You must install at least one module in any of the two slots. Each module can be installed with 8 GB of memory; the total memory capacity is 16 GB.

DDR2 SDRAM memory module table

Memory module	Memory Bus
DDR2 400	200 MHz
DDR2 533	266 MHz
DDR2 667	333 MHz
DDR2 800	400 MHz



Do not remove any memory module from its antistatic packaging until you are ready to install it on the motherboard. Handle the modules only by their edges. Do not touch the components or metal parts. Always wear a grounding strap when you handle the modules.

Installation Procedure

Refer to the following to install the memory modules.

- 1 This motherboard supports unbuffered DDR2 SDRAM only.
- 2 Push the latches on each side of the DIMM slot down.
- 3 Align the memory module with the slot. The DIMM slots are keyed with notches and the DIMMs are keyed with cutouts so that they can only be installed correctly.
- 4 Check that the cutouts on the DIMM module edge connector match the notches in the DIMM slot.
- 5 Install the DIMM module into the slot and press it firmly down until it seats correctly. The slot latches are levered upwards and latch on to the edges of the DIMM.
- 6 Install any remaining DIMM modules.



Installing the Motherboard

Table A: Unbuffered DIMM Support for Socket AM2 CPU

DRAM Speed	DIMM1 ¹	DIMM2 ¹	Timing Mode	Address Timing Control Register	Output Driver Compensation Control Register
DDR2-400	-	Any	1T	002F_2F2Fh	X011_1222h
DDR2-400	Any	Any	2T	002F_2F2Fh	X011_1322h
DDR2-533	-	Any	1T	002F_2F2Fh	X011_1222h
DDR2-533	SRx16	SRx16	2T	002F_2F2Fh	X011_1322h
	SRx16	SRx8			
	SRx8	SRx16			
DDR2-533	SRx8	SRx8	2T	0000_2F2Fh	X011_1322h
DDR2-533	DRx8	DRx8	2T	0034_2F2Fh	X011_1322h
DDR2-533	DRx8	SRx16	2T	0038_2F2Fh	X011_1322h
	SRx16	DRx8			
DDR2-533	DRx8	SRx8	2T	0037_2F2Fh	X011_1322h
	SRx8	DRx8			
DDR2-667	-	Any	1T	0020_2020h	X011_1222h
	SRx16	SRx16			
DDR2-667	SRx16	SRx8	2T	0020_2020h	X011_1322h
	SRx8	SRx16			
DDR2-667	SRx8	SRx8	2T	0030_2020h	X011_1322h
DDR2-667	DRx8	DRx8	2T	002B_2020h	X011_1322h
DDR2-667	DRx8	SRx16	2T	002C_2020h	X011_1322h
	SRx16	DRx8			
DDR2-667	DRx8	SRx8	2T	002A_2020h	X011_1322h
	SRx8	DRx8			
DDR2-800	-	Any	2T	0020_2520h	X011_3222h
DDR2-800	Any	Any	2T	0020_2520h	X011_3222h

1. SRx16=Single Rank x16 DIMM
SRx8=Single Rank x8 DIMM
DRx16=Dual Rank x16 DIMM
DRx8=Dual Rank x8 DIMM

Installing the Motherboard

Table B: DDR2 (memory module) QVL (Qualified Vendor List)

The following DDR2 memory modules have been tested and qualified for use with this motherboard.

Type	Size	Vendor	Module Name	
DDR2 400	256 MB	Samsung	M378T3354BZ0-CCC K4T51163QB-ZCCC	
	512 MB	Samsung	M378T3354BZ0-CCC K4T51183QB-GCC C	
		TwinMos	Samsung K4T51083QB-GCCC 512MB	
DDR2 533	256 MB	Corsair	Aeneon AET94F-370 VC256MB533D2 4PB11D9CHM	
		Epida	E2508AA-D F-E	
		Kingmax	Hynix HY5PS121621	
		Kingston	Epida E5116F-5C-E	
			Infineon HYB18T512260AF-3.7	
		Nanya	NT5TU32M16AG-37B	
		Ramaxel	5PB42 D9DCD	
		Epida D5116AF-5C-E		
	512 MB	Aeneon	Aeneon AET93F370 SS	
		Aeneon	Aeneon AET94F370 DS	
		Corsair	Samsung K4T51083QB-ZCD5	
		Epida	04180WB01	
		Hynix	HY5PS12821	
		Kingston	Infineon	HY818T512800AF37 33346778
			Hynix	HY5PS12821
			Hynix	HYB18T512800AF37
		Ramaxel	5PB32 D9DCN	
			Epida E5108AG-5C-E	
			PC2-4200U-444 LF 6AD11 D9GCT	
		Samsung	K4T51083QC	
	K4T51083QF-ZCD5			
	Twirnos	Epida E5108AB-5C-E		
	1 GB	Apacer	Epida E5108AB-5C-E	
		Geil	A016E2864T2AG8AKT5H120001	
		Infineon	HY818T512800AF37 33344539	
		Kingmax	KKEA88E4AAKG-37	
		UMAX	U2S12D30TP-5C	
DDR2 667	256 MB	Infineon	HYS64T325001HU-3-A HYB18T256	
		Ramxel	5NB31 D9DCG	
	512 MB	A-DATA	AD29608A88-3EG	
		Corsair	VALU ESELECT 32M8CEC	
		GEIL	GL2L64M088BA18W	
		Ramxel	5LB31 D9DCL	
		Samsung	K4T51083QC	
			PC35300U-25331-Z K4T56083QF-ZCE6	
			04400WB01 R050008A	
		Sync MAX	04400WB01 R050008A	
	Transcend	JetRam J12Q3AB-6		
	Twirnos	TMM6208G8M30B		
	1 GB	Samsung	K4T51083QC	
UMAX		U2S12030TP-6E TBF614-L93G		
DDR2 800	512 MB	Infineon	Infineon HYB18T256 800AF25	
		Infinity	04751208CZ5U2D	
	1 GB	Apacer	Apacer AM4B5708BPS8E0634E	
		Infinity	04701G16CZ5U2G	
		UMAX	U2S12D30TP-8E	

Installing the Motherboard

Installing a Hard Disk Drive/CD-ROM/SATA Hard Drive

This section describes how to install IDE devices such as a hard disk drive and a CD-ROM drive.

About IDE Devices

Your motherboard has one IDE interface. An IDE ribbon cable supporting two IDE devices is bundled with the motherboard.



You must orient the cable connector so that the pin1 (color) edge of the cable corresponds to the pin 1 of the I/O port connector.

IDE1: IDE Connector

This motherboard supports four high data transfer SATA ports with each runs up to 3.0 Gb/s. To get better system performance, we recommend users connect the CD-ROM to the IDE channel, and set up the hard drives on the SATA ports.



IDE devices enclose jumpers or switches used to set the IDE device as MASTER or SLAVE. Refer to the IDE device user's manual. Installing two IDE devices on one cable, ensure that one device is set to MASTER and the other device is set to SLAVE. The documentation of your IDE device explains how to do this.

About SATA Connectors

Your motherboard features four SATA connectors supporting a total of four drives. SATA refers to Serial ATA (Advanced Technology Attachment) is the standard interface for the IDE hard drives which are currently used in most PCs. These connectors are well designed and will only fit in one orientation. Locate the SATA connectors on the motherboard and follow the illustration below to install the SATA hard drives.

Installing Serial ATA Hard Drives

To install the Serial ATA (SATA) hard drives, use the SATA cable that supports the Serial ATA protocol. This SATA cable comes with an SATA power cable. You can connect either end of the SATA cable to the SATA hard drive or the connector on the motherboard.



SATA cable (optional)



SATA power cable (optional)

Installing the Motherboard

Refer to the illustration below for proper installation:

- 1 Attach either cable end to the connector on the motherboard.
- 2 Attach the other cable end to the SATA hard drive.
- 3 Attach the SATA power cable to the SATA hard drive and connect the other end to the power supply.



This motherboard does not support the “Hot-Plug” function.

Installing a Floppy Diskette Drive

The motherboard has a floppy diskette drive (FDD) interface and ships with a diskette drive ribbon cable that supports one or two floppy diskette drives. You can install a 5.25-inch drive and a 3.5-inch drive with various capacities. The floppy diskette drive cable has one type of connector for a 5.25-inch drive and another type of connector for a 3.5-inch drive.



You must orient the cable connector so that the pin 1 (color) edge of the cable corresponds to the pin 1 of the I/O port connector.

FDD: Floppy Disk Connector

This connector supports the provided floppy drive ribbon cable. After connecting the single end to the onboard floppy connector, connect the remaining plugs on the other end to the floppy drives correspondingly.



Installing the Motherboard

Installing Add-on Cards

The slots on this motherboard are designed to hold expansion cards and connect them to the system bus. Expansion slots are a means of adding or enhancing the motherboard's features and capabilities. With these efficient facilities, you can increase the motherboard's capabilities by adding hardware that performs tasks that are not part of the basic system.

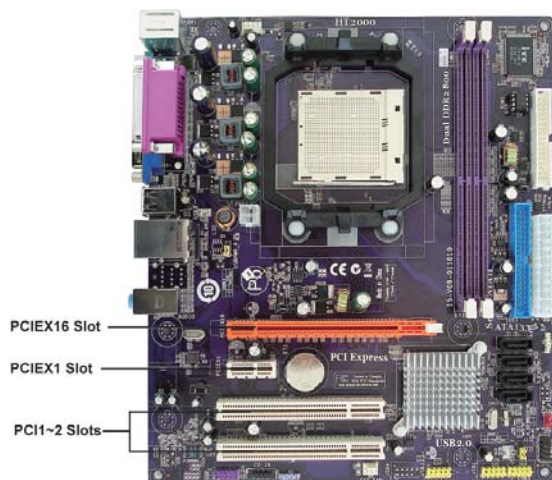

PCIEX16 Slot The PCI Express x16 slot is used to install an external PCI Express graphics card that is fully compliant to the PCI Express Base Specification revision 1.1.

PCIEX1 Slot The PCI Express x1 slot is fully compliant to the PCI Express Base Specification revision 1.1 as well.

PCI1~2 Slots This motherboard is equipped with two standard PCI slots. PCI stands for Peripheral Component Interconnect and is a bus standard for expansion cards, which for the most part, is a supplement of the older ISA bus standard. The PCI slots on this board are PCI v2.3 compliant.



Before installing an add-on card, check the documentation for the card carefully. If the card is not Plug and Play, you may have to manually configure the card before installation.

Installing the Motherboard

Follow these instructions to install an add-on card:

- 1 Remove a blanking plate from the system case corresponding to the slot you are going to use.
- 2 Install the edge connector of the add-on card into the expansion slot. Ensure that the edge connector is correctly seated in the slot.
- 3 Secure the metal bracket of the card to the system case with a screw.

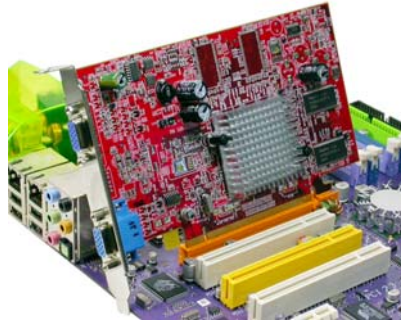

For some add-on cards, for example graphics adapters and network adapters, you have to install drivers and software before you can begin using the add-on card.

Installing the Motherboard

Connecting Optional Devices

Refer to the following for information on connecting the motherboard's optional devices:

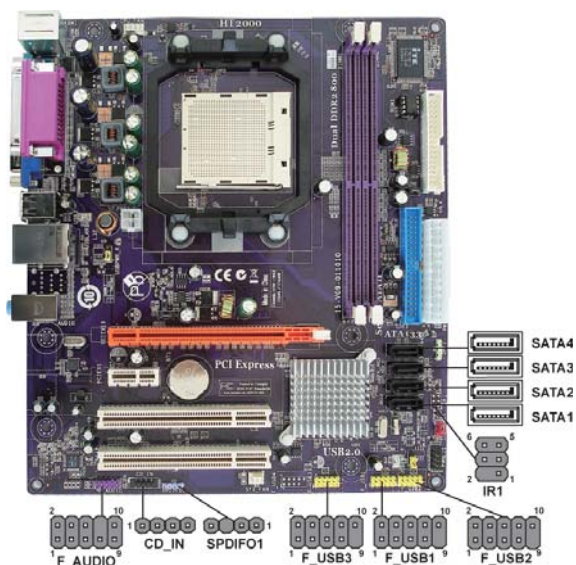

F_AUDIO: Front Panel Audio header

This header allows the user to install auxiliary front-oriented microphone and line-out ports for easier access.

Pin	Signal Name	Pin	Signal Name
1	PORT 1L	2	AUD_GND
3	PORT 1R	4	PRESENCE#
5	PORT 2R	6	SENSE1_RETURN
7	SENSE_SEND	8	KEY
9	PORT 2L	10	SENSE2_RETURN

SATA1-4: Serial ATA connectors

These connectors are used to support the new Serial ATA devices for the highest data transfer rates (3.0 Gb/s), simpler disk drive cabling and easier PC assembly. It eliminates limitations of the current Parallel ATA interface. But maintains register compatibility and software compatibility with Parallel ATA.

Pin	Signal Name	Pin	Signal Name
1	Ground	2	TX+
3	TX-	4	Ground
5	RX-	6	RX+
7	Ground	-	-

Installing the Motherboard

IR1: Infrared header (optional)

The motherboard supports an Infrared (IR1) data port. Infrared ports allow the wireless exchange of information between your computer and similarly equipped devices such as printers, laptops, Personal Digital Assistants (PDAs), and other computers.

Pin	Signal Name	Function
1	Not Assigned	Not assigned
2	Key	No pin
3	+5V	IR Power
4	GND	Ground
5	IR_TX	IrDA serial output
6	IR_RX	IrDA serial input

F_USB1~3: Front Panel USB headers

The motherboard has four USB ports installed on the rear edge I/O port array. Additionally, some computer cases have USB ports at the front of the case. If you have this kind of case, use auxiliary USB connector to connect the front-mounted ports to the motherboard.

Pin	Signal Name	Function
1	USBPWR	Front Panel USB Power
2	USBPWR	Front Panel USB Power
3	USB_FP_P0-	USB Port 0 Negative Signal
4	USB_FP_P1-	USB Port 1 Negative Signal
5	USB_FP_P0+	USB Port 0 Positive Signal
6	USB_FP_P1+	USB Port 1 Positive Signal
7	GND	Ground
8	GND	Ground
9	Key	No pin
10	NC	Not connected



Please make sure that the USB cable has the same pin assignment as indicated above. A different pin assignment may cause damage or system hang-up.

SPDIF01: SPDIF out header

This is an optional header that provides an S/PDIF (Sony/Philips Digital Interface) output to digital multimedia device through optical fiber or coaxial connector.

Pin	Signal Name	Function
1	SPDIF	SPDIF digital output
2	+5VA	5V analog Power
3	Key	No pin
4	GND	Ground

Installing the Motherboard

CD_IN: Analog Audio Input connector

Pin	Signal Name	Function
1	CD_L	CD In left channel
2	GND	Ground
3	GND	Ground
4	CD_R	CD In right channel

Installing the Motherboard

Connecting I/O Devices

The backplane of the motherboard has the following I/O ports:

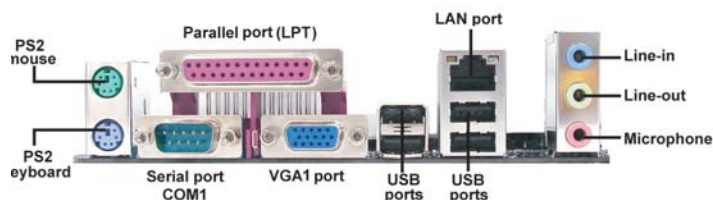

- PS2 Mouse** Use the upper PS/2 port to connect a PS/2 pointing device.
- PS2 Keyboard** Use the lower PS/2 port to connect a PS/2 keyboard.
- Parallel Port (LPT)** Use LPT to connect printers or other parallel communications devices.
- Serial Port (COM1)** Use the COM port to connect serial devices such as mice or fax/modems.
- VGA1 Port** Connect your monitor to the VGA port.
- USB Ports** Use the USB ports to connect USB devices.
- LAN Port** Connect an RJ-45 jack to the LAN port to connect your computer to the Network.
- Audio Ports (optional)** Use the three audio jacks to connect audio devices. The first jack is for stereo line-in signal. The second jack is for stereo line-out signal. The third jack is for microphone.

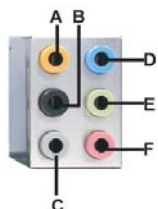

This motherboard may adopt 8-channel audio ports that correspond to the A,B, C, and E port respectively. In addition, all of the 3 ports, B, C, and E provide users with both right & left channels individually. Users please refer to the following note for specific port function definition.

A: Center & Woofer	D: Line-in
B: Back Surround	E: Front Out
C: Side Surround	F: Mic_in Rear

The above port definition can be changed to audio input or audio output by changing the driver utility setting.

This concludes Chapter 2. The next chapter covers the BIOS.

Installing the Motherboard

Memo

Installing the Motherboard

Chapter 3

Using BIOS

About the Setup Utility

The computer uses the latest Phoenix-Award Workstation BIOS with support for Windows Plug and Play. The CMOS chip on the motherboard contains the ROM setup instructions for configuring the motherboard BIOS.

The BIOS (Basic Input and Output System) Setup Utility displays the system's configuration status and provides you with options to set system parameters. The parameters are stored in battery-backed-up CMOS RAM that saves this information when the power is turned off. When the system is turned back on, the system is configured with the values you stored in CMOS.

The BIOS Setup Utility enables you to configure:

- Hard drives, diskette drives and peripherals
- Video display type and display options
- Password protection from unauthorized use
- Power Management features

The settings made in the Setup Utility affect how the computer performs. Before using the Setup Utility, ensure that you understand the Setup Utility options.

This chapter provides explanations for Setup Utility options.

The Standard Configuration

A standard configuration has already been set in the Setup Utility. However, we recommend that you read this chapter in case you need to make any changes in the future.

This Setup Utility should be used:

- when changing the system configuration
- when a configuration error is detected and you are prompted to make changes to the Setup Utility
- when trying to resolve IRQ conflicts
- when making changes to the Power Management configuration
- when changing the password or making other changes to the Security Setup

Entering the Setup Utility

When you power on the system, BIOS enters the Power-On Self Test (POST) routines. POST is a series of built-in diagnostics performed by the BIOS. After the POST routines are completed, the following message appears:

Using BIOS

Press DEL to enter SETUP

Pressing the delete key accesses the BIOS Setup Utility:

Phoenix-Award Workstation BIOS CMOS Setup Utility:

<ul style="list-style-type: none"> ▶ Standard CMOS Features ▶ Advanced BIOS Features ▶ Advanced Chipset Features ▶ Integrated Peripherals ▶ Power Management Setup ▶ PnP/PCI Configurations ▶ PC Health Status 	<ul style="list-style-type: none"> Load Fail-Safe Defaults Load optimized Defaults Set Supervisor Password Set User Password Save & Exit Setup Exit Without Saving
Esc: Quit F10: Save & Exit Setup	↑↓ → ← : Select Item
Time, Date, Hard Disk Type...	

BIOS Navigation Keys

The BIOS navigation keys are listed below:

KEY	FUNCTION
←↑↓→	Move
Enter	Select
+/-/PU/PD	Value
ESC	Exit
F1	General Help
F5	Previous Values
F7	Optimized Defaults
F6	Fail-Safe Defaults
F10	Save

Using BIOS

Updating the BIOS

You can download and install updated BIOS for this motherboard from the manufacturer's Web site. New BIOS provides support for new peripherals, improvements in performance, or fixes for known bugs. Install new BIOS as follows:

- 1 If your motherboard has a BIOS protection jumper, change the setting to allow BIOS flashing.
- 2 If your motherboard has an item called Firmware Write Protect in Advanced BIOS features, disable it. (Firmware Write Protect prevents BIOS from being overwritten.)
- 3 Create a bootable system disk. (Refer to Windows online help for information on creating a bootable system disk.)
- 4 Download the Flash Utility and new BIOS file from the manufacturer's Web site. Copy these files to the system diskette you created in Step 3.
- 5 Turn off your computer and insert the system diskette in your computer's diskette drive. (You might need to run the Setup Utility and change the boot priority items on the Advanced BIOS Features Setup page, to force your computer to boot from the floppy diskette drive first.)
- 6 At the A:\ prompt, type the Flash Utility program name and press <Enter>.
- 7 Type the filename of the new BIOS in the "File Name to Program" text box. Follow the onscreen directions to update the motherboard BIOS.
- 8 When the installation is complete, remove the floppy diskette from the diskette drive and restart your computer. If your motherboard has a Flash BIOS jumper, reset the jumper to protect the newly installed BIOS from being overwritten.

Using BIOS

When you start the Setup Utility, the main menu appears. The main menu of the Setup Utility displays a list of the options that are available. A highlight indicates which option is currently selected. Use the cursor arrow keys to move the highlight to other options. When an option is highlighted, execute the option by pressing <Enter>.

Some options lead to pop-up dialog boxes that prompt you to verify that you wish to execute that option. Other options lead to dialog boxes that prompt you for information.

Some options (marked with a triangle ►) lead to submenus that enable you to change the values for the option. Use the cursor arrow keys to scroll through the items in the submenu.

In this manual, default values are enclosed in parenthesis. Submenu items are denoted by a triangle ►.

Using BIOS

Standard CMOS Features

This option displays basic information about your system.

Phoenix-Award Workstation BIOS CMOS Setup Utility
Standard CMOS Features

Date (mm:dd:yy)	Mon, Jan.8 2007	Item Help
Time (hh:mm:ss)	9 : 14 : 38	
▶ IDE Channel 0 Master	[None]	Menu Level ▶ Change the day, month, year and century
▶ IDE Channel 0 Slave	[None]	
▶ IDE Channel 2 Master	[None]	
▶ IDE Channel 3 Master	[None]	
Drive A	[1.44M, 3.5 in.]	
Video	[EGA/VGA]	
Halt On Setting	[All, But Keyboard]	
Base Memory	640K	
Extended Memory	1047552K	
Total Memory	1048676K	

↑↓ → ← : Move Enter: Select +/-/PU/PD:Value F10:Save ESC:Exit F1:General Help
F5:Previous Values F6: Fail-Safe Defaults F7:Optimized Defaults

Date and Time

The Date and Time items show the current date and time on the computer. If you are running a Windows OS, these items are automatically updated whenever you make changes to the Windows Date and Time Properties utility.

▶ IDE Devices (None)

Your computer has one IDE channel that can be installed with one or two devices (Master and Slave). Use these items to configure each device on the IDE channel.

Press <Enter> to display the IDE submenu:

Phoenix-Award Workstation BIOS CMOS Setup Utility
IDE Channel 0 Master

IDE HDD Auto-Detection	[Press Enter]	Item Help
IDE Channel 0 Master Access Mode	[Auto] [Auto]	
Capacity	80 GB	Menu Level ▶▶ To auto-detect the HDD's size, head... on this channel
Cylinder	38309	
Head	16	
Precomp	0	
Landing Zone	38308	
Sector	255	

↑↓ → ← : Move Enter: Select +/-/PU/PD:Value F10:Save ESC:Exit F1:General Help
F5:Previous Values F6: Fail-Safe Defaults F7:Optimized Defaults

Using BIOS

IDE HDD Auto-Detection

Press <Enter> while this item is highlighted to prompt the Setup Utility to automatically detect and configure an IDE device on the IDE channel.



If you are setting up a new hard disk drive that supports LBA mode, more than one line will appear in the parameter box. Choose the line that lists LBA for an LBA drive.

IDE Channel 0/2/3 Master & IDE Channel 0 Slave

Leave this item at Auto to enable the system to automatically detect and configure IDE devices on the channel. If it fails to find a device, change the value to Manual and then manually configure the drive by entering the characteristics of the drive in the items described below.



Before attempting to configure a hard disk drive, ensure that you have the configuration information supplied by the manufacturer of your hard drive. Incorrect settings can result in your system not recognizing the installed hard disk.

Access Mode (Auto)

This item defines ways that can be used to access IDE hard disks such as LBA (Large Block Addressing). Leave this value at Auto and the system will automatically decide the fastest way to access the hard disk drive.

Press <Esc> to return to the Standard CMOS Features page.

Drive A (1.44M, 3.5 in.)

This item defines the characteristics of any diskette drive attached to the system.

Video (EGA/VGA)

This item defines the video mode of the system. The motherboard has a built-in VGA graphics system; you must leave this item at the default value.

Halt On (All, But Keyboard)

This item defines the operation of the system POST (Power On Self Test) routine. You can use this item to select which types of errors in the POST are sufficient to halt the system.

Base Memory, Extended Memory, and Total Memory

These items are automatically detected by the system at start up time. These are display-only fields. You cannot make changes to these fields.

Press <Esc> to return to the main menu setting page.

Using BIOS

Advanced BIOS Features

This option defines advanced information about your system.

Phoenix-Award WorkstationBIOS CMOS Setup Utility
Advanced BIOS Features

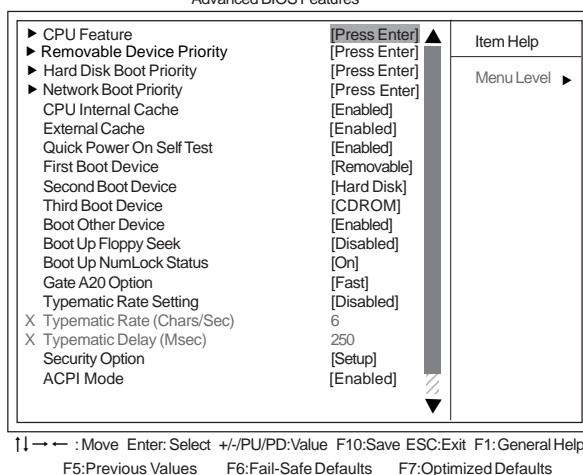

▶ CPU Feature (Press Enter)

Scroll to this item and press <Enter> to view the following screen:

Phoenix-Award WorkstationBIOS CMOS Setup Utility
CPU Feature

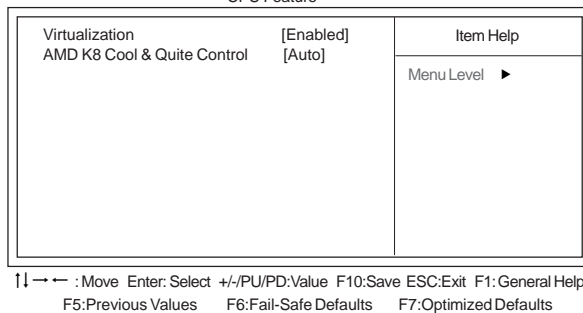

Virtualization (Enabled)

Hardware Virtualization Technology enables processor feature for running multiple simultaneous Virtual Machines allowing specialized software applications to run in full isolation of each other.

AMD K8 Cool & Quiet Control (Auto)

This item helps the system to lower the frequency when CPU idles. When the frequency decreases, the temperature will drop automatically as well.

Press <Esc> to return to Advanced BIOS Features page.

Using BIOS

► Removable Device Priority (Press Enter)

Scroll to this item and press <Enter> to view the following screen:

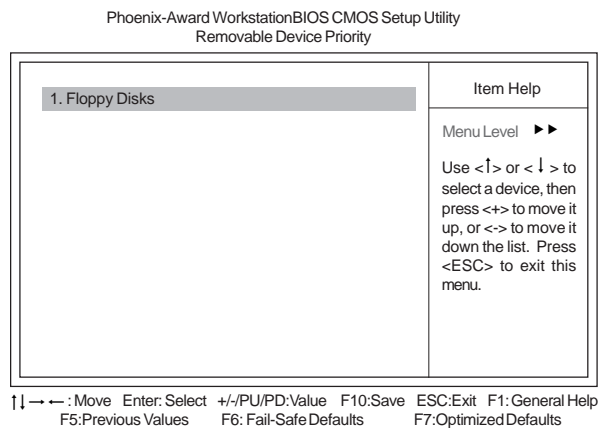

Press <Esc> to return to Advanced BIOS Features page.

► Hard Disk Boot Priority (Press Enter)

Scroll to this item and press <Enter> to view the following screen:

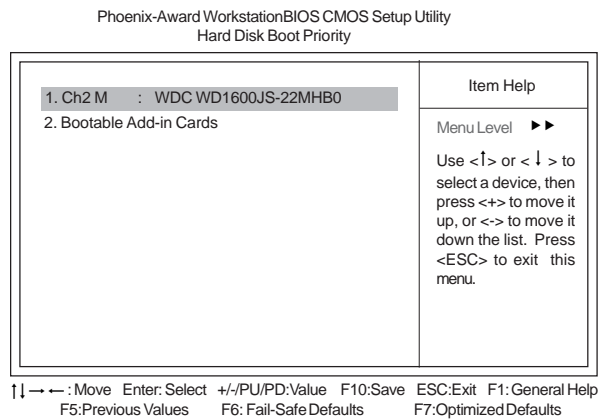

Press <Esc> to return to Advanced BIOS Features page.

Using BIOS

► Network Boot Priority (Press Enter)

Scroll to this item and press <Enter> to view the following screen:

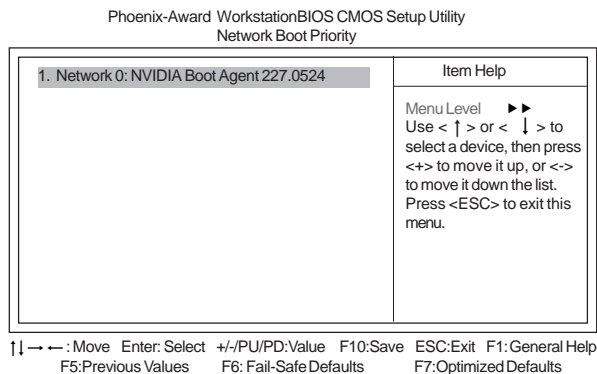

Press <Esc> to return to Advanced BIOS Features page.

CPU Internal Cache (Enabled)

All processors that can be installed in this motherboard use internal level 1 (L1) cache memory to improve performance. Leave this item at the default value for better performance.

External Cache (Enabled)

Most processors that can be installed in this system use external level 2 (L2) cache memory to improve performance. Leave this item at the default value for better performance.

Quick Power On Self Test (Enabled)

Enable this item to shorten the power on testing (POST) and have your system start up faster. You might like to enable this item after you are confident that your system hardware is operating smoothly.

First/Second/Third Boot Device (Removable/Hard Disk/CDROM)

Use these three items to select the priority and order of the devices that your system searches for an operating system at start-up time.

Boot Other Device (Enabled)

When enabled, the system searches all other possible locations for an operating system if it fails to find one in the devices specified under the First, Second, and Third boot devices.

Boot Up Floppy Seek (Disabled)

If this item is enabled, it checks the size of the floppy disk drives at start-up time. You don't need to enable this item unless you have a legacy diskette drive with

Boot Up NumLock Status (On)

This item defines if the keyboard Num Lock key is active when your system is started.

Using BIOS

Gate A20 Option (Fast)

This item defines how the system handles legacy software that was written for an earlier generation of processors. Leave this item at the default value.

Typematic Rate Setting (Disabled)

If this item is enabled, you can use the following two items to set the typematic rate and the typematic delay settings for your keyboard.

- **Typematic Rate (Chars/Sec):** Use this item to define how many characters per second are generated by a held-down key.
- **Typematic Delay (Msec):** Use this item to define how many milliseconds must elapse before a held-down key begins generating repeat characters.

Security Option (Setup)

If you have installed password protection, this item defines if the password is required at system start up, or if it is only required when a user tries to enter the Setup Utility.

APIC Mode (Enabled)

This item allows you to enable or disable the APIC (Advanced Programmable Interrupt Controller) mode. APIC provides symmetric multi-processing (SMP) for systems, allowing support for up to 60 processors.

MPS Version Control For OS (1.4)

This item displays MPS version control for OS.

OS Select For DRAM > 64 MB (Non-OS2)

This item is only required if you have installed more than 64 MB of memory and you are running the OS/2 operating system. Otherwise, leave this item at the default.

Small Logo (EPA) Show (Disabled)

Enables or disables the display of the EPA logo during boot.

Summary Screen Show (Enabled)

Enables or disables the display of the summary screen during boot.

ATA 66/100 IDE Cable Msg. (Enabled)

This item enables or disables the display of the ATA 66/100 Cable MSG.

Press <Esc> to return to the main menu setting page.

Using BIOS

Advanced Chipset Features

These items define critical timing parameters of the motherboard. You should leave the items on this page at their default values unless you are very familiar with the technical specifications of your system hardware. If you change the values incorrectly, you may introduce fatal errors or recurring instability into your system.

Phoenix-Award Workstation BIOS CMOS Setup Utility
Advanced Chipset Features

		Item Help
Frame Buffer Size	[Auto]	
GPU Bank Flip	[Disabled]	
PMU	[Disabled]	
CPU Frequency	[200.0]	
K8<->NB HT Speed	[Auto]	
K8<->NB HT Width	[Auto]	
▶ DRAM Configuration	[Press Enter]	
PCIE Spread Spectrum	[Disabled]	
SATA Spread Spectrum	[Disabled]	
HT Spread Spectrum	[Disabled]	
PCIE Clock	[100Mhz]	
SSE/SSE2 Instructions	[Enabled]	
System BIOS Cacheable	[Disabled]	
		Menu Level ▶

↑↓ → ← : Move Enter: Select +/-/PU/PD: Value F10: Save ESC: Exit F1: General Help
F5: Previous Values F6: Fail-Safe Defaults F7: Optimized Defaults

Frame Buffer Size (Auto)

This item enables users to specify the Onboard VGA share memory size.

GPU Bank Flip (Disabled)

This item enables or disables GPU Bank flip.

PMU (Disabled)

This item enables or disables ACPI power management unit function.

CPU Frequency (200.0)

This item enables users to manually over-clock the CPU frequency, ranging from 200.0 to 300.0.

K8 <-> NB HT Speed (Auto)

This item enables users to set the speed of HyperTransport between the CPU and Northbridge.

K8 <-> NB HT Width (Auto)

This item enables users to set the HyperTransport width between CPU and the Northbridge .

Using BIOS

► DRAM Configuration (Press Enter)

Scroll to this item and press <Enter> to view the following screen:

Phoenix-AwardBIOS CMOS Setup Utility
DRAM Configuration

Timing Mode	[Auto]	Item Help
x Memclock index value or Limi	DDR2 400	Menu Level ► Auto, no user limit MaxMemClk, limit by Memory Clock value
DQS Training Control	[Skip DQS]	
DCTs Mode	[Ganged]	
CKE base power down mode	[Disabled]	
CKE based powerdown	[Per channel]	
Memclock tri-stating	[Disabled]	
Auto Optimize Bottom IO	[Enabled]	
x Bottom of [31:24] IO space	E0	
Bottom of UMA DRAM [31:24]	[FC]	

↑↓ ← → : Move Enter: Select +/-/PU/PD: Value F10: Save ESC: Exit F1: General Help
F5: Previous Values F6: Fail-Safe Defaults F7: Optimized Defaults

Timing Mode (Auto)

This item allows you to set up the DRAM timing manually or automatically.

- **Memory Clock value or Limi (DDR2 400)** When DDR2 Timing Setting by is set to Manual, use this item to set the DRAM frequency.

DQS Training Control (Skip DQS)

DQS training is used to place the DQS strobe in the center of the data eye.

DCTs Mode (Ganged)

This item is used to select the Dram ConTrollers Mode.

CKE base power down mode (Disabled)

When in power down mode, if all pages of the DRAMs associated with a CKE pin are closed, then these parts are placed in power down mode. Only pre-charge power down mode is supported, not active power down mode.

CKE based powerdown (Per Channel)

The DRAM channel is placed in power down when all chip selects associated with the channel are idle.

Memclock tri-stating (Disabled)

This item enables or disables memclock tri-stating function.

Auto Optimize Bottom IO (Enabled)

This item is used to set the Auto Optimized Bottom IO.

- **Bottom of [31:24] IO space (E0)** This item is used to select the memory that will be remapped higher than 00E0.

Bottom of UMA DRAM [31:24] (FC)

This item is used to set the bottom of UMA DRAM [31:24]. We strongly recommend that you leave this item at its default setting.

Press <Esc> to return to Advanced Chipset Features page.

Using BIOS

PCIE Spread Spectrum (Disabled)

This item, when enabled, can significantly reduce the EMI (Electromagnetic Interference) generated by the PCIE.

SATA Spread Spectrum (Disabled)

This item, when enabled, can significantly reduce the EMI (Electromagnetic Interference) generated by the SATA.

HT Spread Spectrum (Disabled)

This item, when enabled, can significantly reduce the EMI (Electromagnetic Interference) generated by the HT.

PCIE Clock (100Mhz)

This item is used to set the frequency of PCIE clock.

SSE/SSE2 Instructions (Enabled)

This item enables or disables SSE/SSE2 instructions.

System BIOS Cacheable (Disabled)

This item enables users to enable or disable the system BIOS cache.

Press <Esc> to return to the main menu setting page.

Integrated Peripherals

These options display items that define the operation of peripheral components on the system's input/output ports.

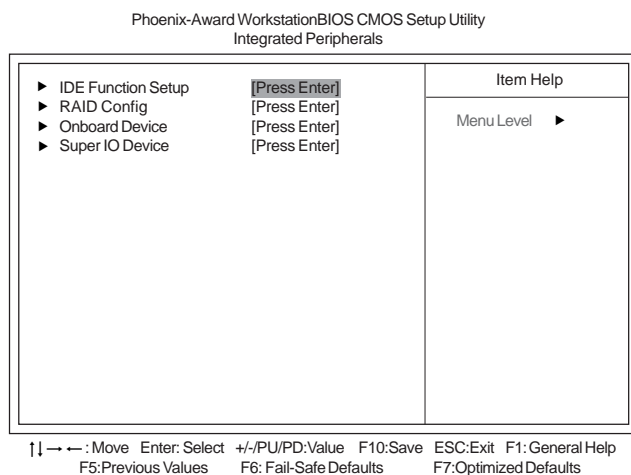

▶ IDE Function Setup (Press Enter)

Scroll to this item and press <Enter> to view the following screen:

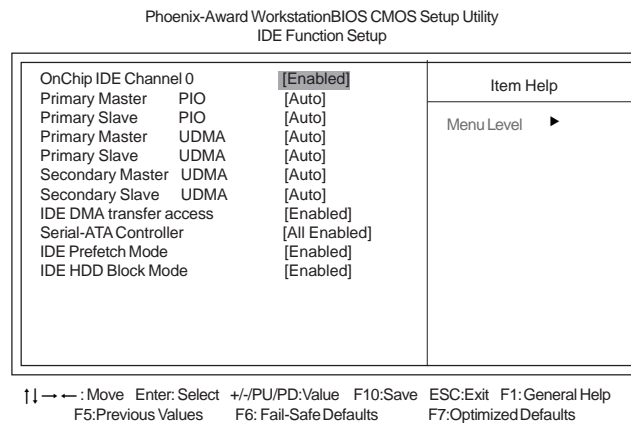

On-Chip IDE Channel 0 (Enabled)

Use these items to enable or disable the PCI IDE channels that are integrated on the motherboard.

Primary Master/Slave PIO (Auto)

Each IDE channel supports a master device and a slave device. These four items let you assign the kind of PIO (Programmed Input/Output) was used by the IDE devices. Choose Auto to let the system auto detect which PIO mode is best, or select a PIO mode from 0-4.

Using BIOS

Primary/Secondary Master/Slave UDMA (Auto)

Each IDE channel supports a master device and a slave device. This motherboard supports UltraDMA technology, which provides faster access to IDE devices.

If you install a device that supports UltraDMA, change the appropriate item on this list to Auto. You may have to install the UltraDMA driver supplied with this motherboard in order to use an UltraDMA device.

IDE DMA transfer access (Enabled)

This item allows you to enable the transfer access of the IDE DMA then burst onto the PCI bus and nonburstable transactions do not.

Serial-ATA Controller (All Enabled)

This item allows you to enable or disable the onboard SATA controller.

IDE Prefetch Mode (Enabled)

The onboard IDE drive interface supports IDE prefetching, for faster drive access. If you install a primary and secondary add-in IDE interface, set this field to Disabled if the interface does not support prefetching.

IDE HDD Block Mode (Enabled)

Enables this field if your IDE hard drive supports block mode. Block mode enables BIOS to automatically detect the optimal number of block read and writes per sector that the drive can support and improves the speed of access to IDE devices.

Press <Esc> to return to the Integrated Peripherals page.

► RAID Config (Press Enter)

Scroll to this item and press <Enter> to view the following screen:

Phoenix-Award Workstation BIOS CMOS Setup Utility
RAID Config

<table style="width: 100%; border-collapse: collapse;"> <tr> <td style="width: 30%;">RAID Enable</td> <td style="width: 30%;"></td> <td style="width: 30%; text-align: center;">Disabled</td> </tr> <tr> <td>x SATA 1 Primary</td> <td>RAID</td> <td>Disabled</td> </tr> <tr> <td>x SATA 1 Secondary</td> <td>RAID</td> <td>Disabled</td> </tr> <tr> <td>x SATA 2 Primary</td> <td>RAID</td> <td>Disabled</td> </tr> <tr> <td>x SATA 2 Secondary</td> <td>RAID</td> <td>Disabled</td> </tr> </table>	RAID Enable		Disabled	x SATA 1 Primary	RAID	Disabled	x SATA 1 Secondary	RAID	Disabled	x SATA 2 Primary	RAID	Disabled	x SATA 2 Secondary	RAID	Disabled	<table style="width: 100%; border-collapse: collapse;"> <tr> <td style="text-align: center;">Item Help</td> </tr> <tr> <td style="padding-top: 10px;">Menu Level ►►</td> </tr> </table>	Item Help	Menu Level ►►
RAID Enable		Disabled																
x SATA 1 Primary	RAID	Disabled																
x SATA 1 Secondary	RAID	Disabled																
x SATA 2 Primary	RAID	Disabled																
x SATA 2 Secondary	RAID	Disabled																
Item Help																		
Menu Level ►►																		

[↑] → ←: Move Enter: Select +/-/PU/PD: Value F10: Save ESC: Exit F1: General Help
 F5: Previous Values F6: Fail-Safe Defaults F7: Optimized Defaults

RAID Enable (Disabled)

This item allows you to enable or disable the onboard RAID function of RAID function of RAID supporting devices.

- **SATA 1/2 Primary/Secondary RAID (Disabled)**: These four items enables or disables SATA 1/2 Primary/ Secondary RAID.

Press <Esc> to return to the Integrated Peripherals page.

Using BIOS

► Onboard Device Setup (Press Enter)

Scroll to this item and press <Enter> to view the following screen:

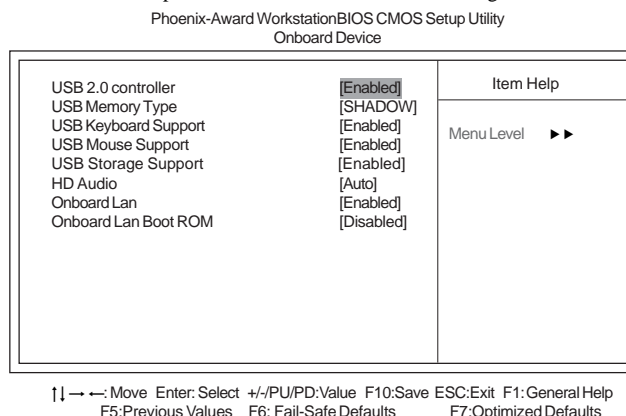

USB 2.0 controller (Enabled)

Enable this item if want to use the USB 2.0.

USB Memory Type (SHADOW)

This item indicates the USB memory type.

USB Keyboard Support (Enabled)

Enable this item if you plan to use a keyboard connected through the USB port in a legacy operating system (such as DOS) that does not support Plug and Play.

USB Mouse Support (Enabled)

Enable this item if you plan to use a mouse connected through the USB port in a legacy operating system (such as DOS) that does not support Plug and Play.

USB Storage Support (Enabled)

Use this item to enable or disable the USB Storage function.

HD Audio(Auto)

Enables and disables the onboard audio chip. Disable this item if you are going to install a PCI audio add-in card.

Onboard Lan (Enabled)

Enables or disables the Onboard Lan.

Onboard Lan Boot ROM (Disabled)

This item enables or disables LAN Boot ROM.

Press <Esc> to return to the Integrated Peripherals page.

Using BIOS

► SuperIO Device (Press Enter)

Scroll to this item and press <Enter> to view the following screen:

Phoenix-Award Workstation BIOS CMOS Setup Utility
Super IO Device

		Item Help
Onboard FDC Controller	[Enabled]	
Onboard Serial Port 1	[3F8/IRQ4]	
Onboard Parallel Port	[378/IRQ7]	Menu Level ►►
Parallel Port Mode	[SPP]	
x ECP Mode Use DMA	3	

[↑] → ← : Move Enter: Select +/-/PU/PD:Value F10:Save ESC:Exit F1:General Help
F5:Previous Values F6: Fail-Safe Defaults F7:Optimized Defaults

Onboard FDC Controller (Enabled)

This option enables the onboard floppy disk drive controller.

Onboard Serial Port 1 (3F8/IRQ4)

This option is used to assign the I/O address and interrupt request (IRQ) for onboard serial port 1.

Onboard Parallel Port (378/IRQ7)

This item enables or disables the onboard parallel port, and assigns a port address. The Auto setting will detect the available address.

Parallel Port Mode (SPP)

Use this item to select the parallel port mode. You can select Normal (Standard Parallel Port), ECP (Extended Capabilities Port), EPP (Enhanced Parallel Port), or BPP (Bi-Directional Parallel Port).

- **ECP Mode Use DMA (3)**: When the onboard parallel port is set to ECP mode, the parallel port can use DMA3/1.

Press <Esc> to return to the Integrated Peripherals page.

Using BIOS

Power Management Setup

This option lets you control system power management. The system has various power-saving modes including powering down the hard disk, turning off the video, suspending to RAM, and software power down that allows the system to be automatically resumed by certain events.

Phoenix-Award Workstation BIOS CMOS Setup Utility
Power Management Setup

ACPI Suspend Type	[S3]	Item Help
Soft-Off by PBTN	[Instant-Off]	
HPET Support	[Disabled]	
Resume By PCI PME	[Disabled]	Menu Level ▶
Resume By WOM/RING	[Disabled]	
Resume By USB (S3)	[Disabled]	
Resume By PS2 MS(S3)	[Disabled]	
Resume By PS2 KB(S3)	[Disabled]	
Power-On by Alarm	[Disabled]	
X Day of Month Alarm	0	
X Time (hh:mm:ss) Alarm	0 : 0 : 0	
Power on After Power Fial	[Off]	

↑↓ → ← : Move Enter: Select +/-/PU/PD: Value F10: Save ESC: Exit F1: General Help
F5: Previous Values F6: Fail-Safe Defaults F7: Optimized Defaults

ACPI Suspend Type (S3)

Use this item to define how your system suspends. In the default, S3 (STR), the suspend mode is a suspend to RAM, i.e., the system shuts down with the exception of a refresh current to the system memory.

Soft-Off by PBTN (Instant-Off)

Under ACPI (Advanced Configuration and Power management Interface) you can create a software power down. In a software power down, the system can be resumed by Wake Up Alarms. This item lets you install a software power down that is controlled by the power button on your system. If the item is set to Instant-Off, then the power button causes a software power down. If the item is set to Delay 4 Sec. then you have to hold the power button down for four seconds to cause a software power down.

HPET Support (Disabled)

This item enables or disables HPET (High Precision Event Timer) support.

Resume by PCI PME (Disabled)

This system can be turned off with a software command. If you enable this item, the system can automatically resume if there is an incoming call on the PCI Modem card or PCI LAN card. You must use an ATX power supply in order to use this feature. Use this item to do wake-up action if inserting the PCI card.

Using BIOS

Resume by WOM/RING (Disabled)

An input signal on the serial Ring indicator (RI) line (in other words, and incoming call on the modem) awakens the system from a soft off state.

Resume By USB (S3) (Disabled)

This item allows users to enable or disable the USB device Walk-up from S3 mode.

Resume By PS2 MS/KB(S3) (Disabled)

These items enable or disable you to allow mouse or keyboard activity to awaken the system from power saving mode.

Power-On by Alarm (Disabled)

This item allows users to enable or disable the alarm to wake up the system. If set to Enabled, users can specify the specific day of month and the exact time to power up the system.

- **Date of Month Alarm:** Use this item to define the date of month when using the RTC alarm to resume the system.
- **Time (hh:mm:ss) Alarm:** Use this item to define the time when using the RTC alarm to resume the system.

Power On After Power Fail (Off)

This item enables your computer to automatically restart or return to its last operating status.

Press <Esc> to return to the main menu setting page.

PNP/PCI Configurations

These options configure how PnP (Plug and Play) and PCI expansion cards operate in your system. Both the the ISA and PCI buses on the motherboard use system IRQs (Interrupt ReQuests) and DMAs (Direct Memory Access). You must set up the IRQ and DMA assignments correctly through the PnP/PCI Configurations Setup utility for the motherboard to work properly. Selecting PnP/PCI Configurations on the main program screen displays this menu:

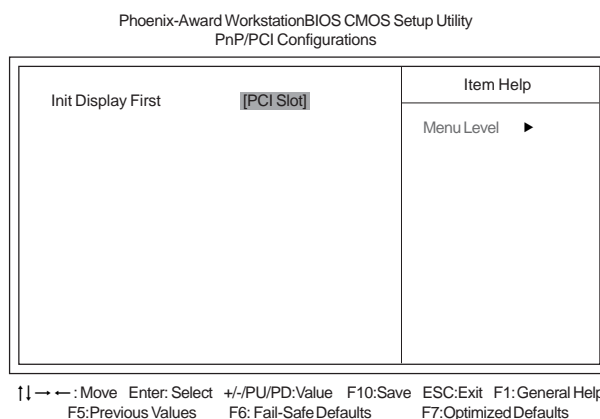
**Using BIOS**

Init Display First (PCI Slot)

This item allows you to choose the primary display card.

Press <Esc> to return to the main menu setting page.

PC Health Status

On motherboards that support hardware monitoring, this item lets you monitor the parameters for critical voltages, temperatures and fan speeds.

Phoenix-Award Workstation BIOS CMOS Setup Utility
PC Health Status

▶ Smart Fan Function	[Press Enter]	Item Help
Shutdown Temperature	[Disabled]	Menu Level ▶
CPU Tcontrol	40° C	
System Temperature	29° C	
CPU Fan Speed	5532 RPM	
CPU Vcore	1.31V	
VDIMM	1.87V	
+5V	5.08V	

↑↓ → ← : Move Enter: Select +/-/PU/PD: Value F10: Save ESC: Exit F1: General Help
F5: Previous Values F6: Fail-Safe Defaults F7: Optimized Defaults

▶ Smart Fan Function (Press Enter)

Scroll to this item and press <Enter> to view the following screen:

Phoenix-Award Workstation BIOS CMOS Setup Utility
Smart Fan Function

CPU Smart Fan Function	[Disabled]	Item Help
X CPU FAN Low PWM	0	Menu Level ▶▶
X CPU FAN Temp of Low PWM° C	0	
X CPU FAN Slope (PWM° C)	0	
X CPU SMART FAN Delta T	0	

↑↓ → ← : Move Enter: Select +/-/PU/PD: Value F10: Save ESC: Exit F1: General Help
F5: Previous Values F6: Fail-Safe Defaults F7: Optimized Defaults

Using BIOS

CPU Smart Fan Function (Disabled)

These items enable you to define the CPU/System temperature by smartly adjusting the CPU/System fan. When it is set at certain temperature, the CPU/SYS Fan PWM value will change accordingly.

Press <Esc> to return to the PC Health Status page.

Shutdown Temperature (Disabled)

Enables you to set the maximum temperature the system can reach before powering down.

System Component Characteristics

These fields provide you with information about the systems current operating status. You cannot make changes to these fields.

- CPU Tcontrol
- System Temperature
- CPU Fan Speed
- CPU Vcore
- VDIMM
- +5V

Press <Esc> to return to the main menu setting page.

Load Fail-Safe Defaults

This option opens a dialog box that lets you install fail-safe defaults for all appropriate items in the Setup Utility:

Press <Y> and then <Enter> to install the defaults. Press <N> and then <Enter> to not install the defaults. The fail-safe defaults place no great demands on the system and are generally stable. If your system is not functioning correctly, try installing the fail-safe defaults as a first step in getting your system working properly again. If you only want to install fail-safe defaults for a specific option, select and display that option, and then press <F6>.

Load Optimized Defaults

This option opens a dialog box that lets you install optimized defaults for all appropriate items in the Setup Utility. Press <Y> and then <Enter> to install the defaults. Press <N> and then <Enter> to not install the defaults. The optimized defaults place demands on the system that may be greater than the performance level of the components, such as the CPU and the memory. You can cause fatal errors or instability if you install the optimized defaults when your hardware does not support them. If you only want to install setup defaults for a specific option, select and display that option, and then press <F7>.



User please remain the factory BIOS default setting of "Load Optimized Defaults" When install Operation System onto your system.

Using BIOS

Set Supervisor/User Password

When this function is selected, the following message appears at the center of the screen to assist you in creating a password.

ENTER PASSWORD

Type the password, up to eight characters, and press <Enter>. The password typed now will clear any previously entered password from CMOS memory. You will be asked to confirm the password. Type the password again and press <Enter>. You may also press <Esc> to abort the selection.

To disable password, just press <Enter> when you are prompted to enter password. A message will confirm the password being disabled. Once the password is disabled, the system will boot and you can enter BIOS Setup freely.

PASSWORD DISABLED

If you have selected “**System**” in “Security Option” of “BIOS Features Setup” menu, you will be prompted for the password every time the system reboots or any time you try to enter BIOS Setup.

If you have selected “**Setup**” at “Security Option” from “BIOS Features Setup” menu, you will be prompted for the password only when you enter BIOS Setup.

Supervisor Password has higher priority than User Password. You can use Supervisor Password when booting the system or entering BIOS Setup to modify all settings. Also you can use User Password when booting the system or entering BIOS Setup but can not modify any setting if Supervisor Password is enabled.

Save & Exit Setup

Highlight this item and press <Enter> to save the changes that you have made in the Setup Utility and exit the Setup Utility. When the Save and Exit dialog box appears, press <Y> to save and exit, or press <N> to return to the main menu.

Exit Without Saving

Highlight this item and press <Enter> to discard any changes that you have made in the Setup Utility and exit the Setup Utility. When the Exit Without Saving dialog box appears, press <Y> to discard changes and exit, or press <N> to return to the main menu.



If you have made settings that you do not want to save, use the “Exit Without Saving” item and press <Y> to discard any changes you have made.

This concludes Chapter 3. Refer to the next chapter for information on the software supplied with the motherboard.

Using BIOS

Memo

Using BIOS

Chapter 4

Using the Motherboard Software

About the Software CD-ROM

The support software CD-ROM that is included in the motherboard package contains all the drivers and utility programs needed to properly run the bundled products. Below you can find a brief description of each software program, and the location for your motherboard version. More information on some programs is available in a README file, located in the same directory as the software. Before installing any software, always inspect the folder for files named README.TXT, INSTALL.TXT, or something similar. These files may contain important information that is not included in this manual.



1. *Never try to install all software from folder that is not specified for use with your motherboard.*
2. *The notice of Intel HD audio installation (optional): The Intel High Definition audio functionality unexpectedly quits working in Windows Server 2003 Service Pack 1 or Windows XP Professional x64 Edition. Users need to download and install the update packages from the Microsoft Download Center “before” installing HD audio driver bundled in the Driver CD. Please log on to <http://support.microsoft.com/default.aspx?scid=kb;en-us;901105#apliesto> for more information.*

Auto-installing under Windows 2000/XP/Vista

The Auto-install CD-ROM makes it easy for you to install the drivers and software for your motherboard.



If the Auto-install CD-ROM does not work on your system, you can still install drivers through the file manager for your OS (for example, Windows Explorer). Refer to the Utility Folder Installation Notes later in this chapter.

The support software CD-ROM disc loads automatically under Windows 2000/XP/Vista. When you insert the CD-ROM disc in the CD-ROM drive, the autorun feature will automatically bring up the install screen. The screen has three buttons on it, Setup, Browse CD and Exit.

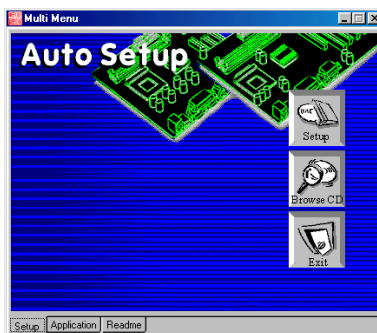

If the opening screen does not appear; double-click the file “setup.exe” in the root directory.

Using the Motherboard Software

Setup Tab

Setup	Click the Setup button to run the software installation program. Select from the menu which software you want to install.
Browse CD	<p>The Browse CD button is the standard Windows command that allows you to open Windows Explorer and show the contents of the support CD.</p> <p>Before installing the software from Windows Explorer, look for a file named README.TXT, INSTALL.TXT or something similar. This file may contain important information to help you install the software correctly.</p> <p>Some software is installed in separate folders for different operating systems, such as Windows 2000/XP/Vista. Always go to the correct folder for the kind of OS you are using.</p> <p>In install the software, execute a file named SETUP.EXE or INSTALL.EXE by double-clicking the file and then following the instructions on the screen.</p>
Exit	The EXIT button closes the Auto Setup window.

Application Tab

Lists the software utilities that are available on the CD.

Read Me Tab

Displays the path for all software and drivers available on the CD.

Running Setup

Follow these instructions to install device drivers and software for the motherboard:

1. Click **Setup**. The installation program begins:

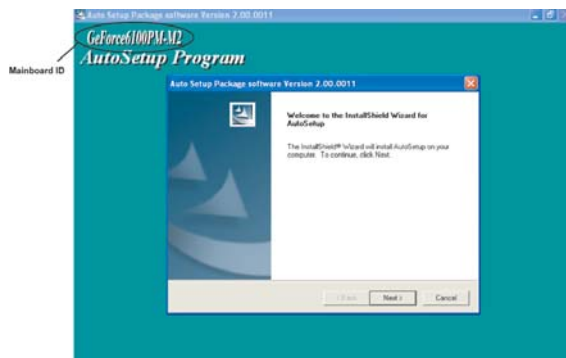

The following screens are examples only. The screens and driver lists will be different according to the motherboard you are installing.

The motherboard identification is located in the upper left-hand corner.

Using the Motherboard Software

2. Click **Next**. The following screen appears:

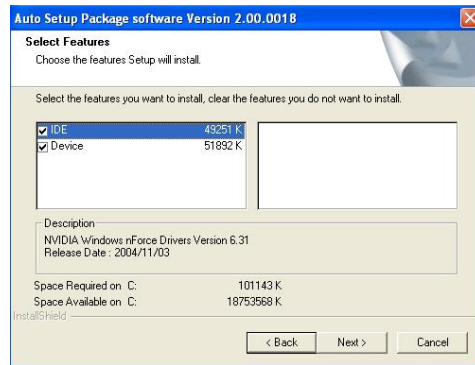

3. Check the box next to the items you want to install. The default options are recommended.
4. Click **Next** run the Installation Wizard. An item installation screen appears:

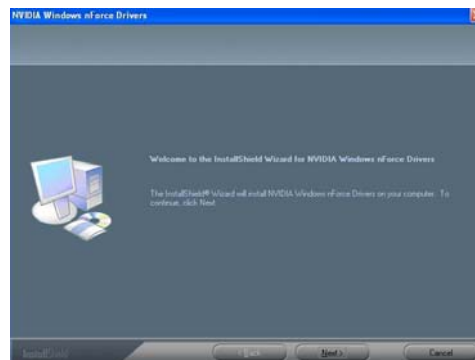

5. Follow the instructions on the screen to install the items.



1. Drivers and software are automatically installed in sequence. Follow the onscreen instructions, confirm commands and allow the computer to restart a few times to complete the installation.

2. During the Windows Vista Driver Auto Setup Procedure, users should use one of the following two methods to install the driver after the system restart.

Using the Motherboard Software

Method 1. Run Reboot Setup

Windows Vista will block startup programs by default when installing drivers after the system restart. You must select taskbar icon **Run Blocked Program** and run **Reboot Setup** to install the next driver, until you finish all drivers installation.

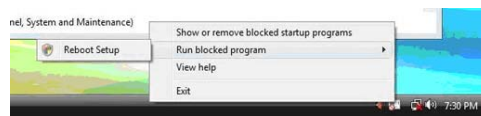
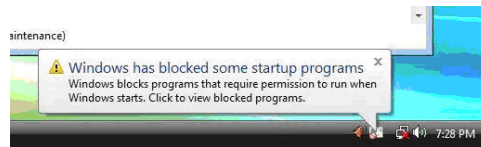

Method 2. Disable UAC (User Account Control)

* For administrator account only. Standard user account can only use Method 1.

Disable Vista UAC function before installing drivers, then use CD driver to install drivers, it will continue to install drivers after system restart without running blocked programs.

Follow these instructions to Disable Vista UAC function:

1. Go to **Control Panel**.

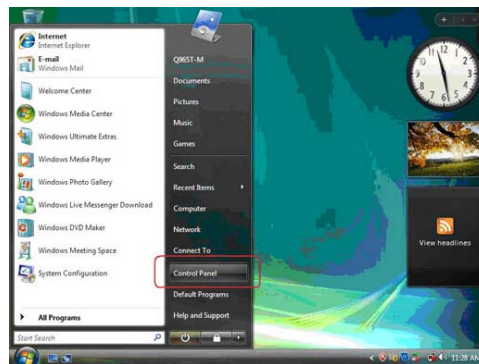

Using the Motherboard Software

2. Select **Classic View**.

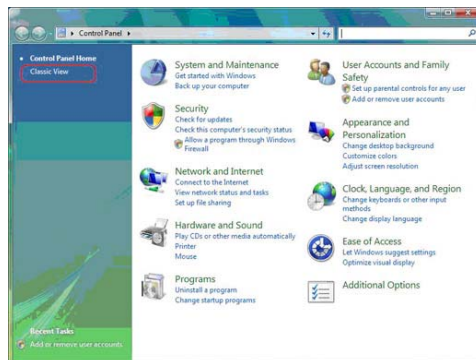

3. Set **User Account**.

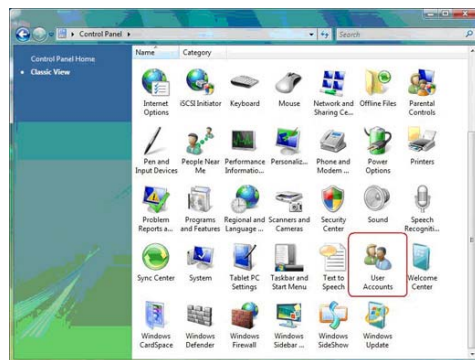

4. Select **Turn User Account Control on or off** and press **Continue**.

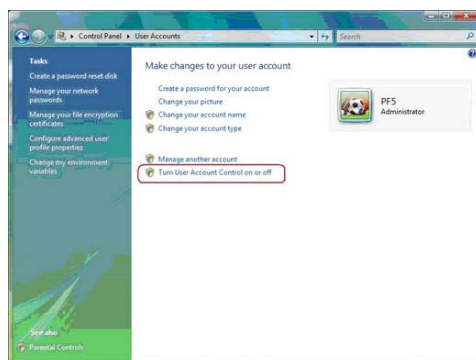

Using the Motherboard Software

5. Disable **User Account Control (UAC) to help protect your computer** item and press **OK**, then press **Restart Now**. Then you can restart your computer and continue to install drivers without running blocked programs.

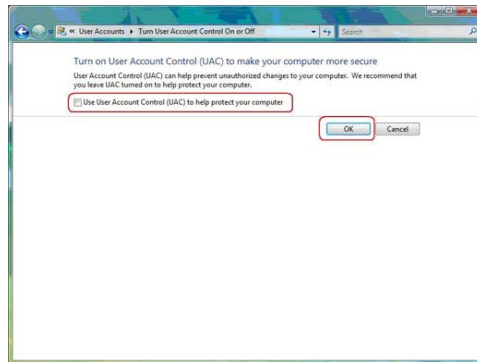

Manual Installation

Insert the CD in the CD-ROM drive and locate the PATH.DOC file in the root directory. This file contains the information needed to locate the drivers for your motherboard.

Look for the chipset and motherboard model; then browse to the directory and path to begin installing the drivers. Most drivers have a setup program (SETUP.EXE) that automatically detects your operating system before installation. Other drivers have the setup program located in the operating system subfolder.

If the driver you want to install does not have a setup program, browse to the operating system subfolder and locate the readme text file (README.TXT or README.DOC) for information on installing the driver or software for your operating system.

Utility Software Reference

All the utility software available from this page is Windows compliant. They are provided only for the convenience of the customer. The following software is furnished under license and may only be used or copied in accordance with the terms of the license.



1. These software(s) are subject to change at anytime without prior notice. Please refer to the support CD for available software.
2. Please go to ECS website to download AMD Cool'n'Quiet™ technology.

This concludes chapter 4.

Using the Motherboard Software

Chapter 5

Setting Up NVIDIA RAID Configuration

Setting Up a Non-Bootable RAID Array

RAID arrays can be created/deleted using both MediaShield RAID BIOS and the MediaShield RAID Manager from Windows. This section only covers basic BIOS setup required for non-bootable array. See the section "Setting Up a Bootable RAID Array" for instructions on configuring the RAID array in BIOS. See sections on using the MediaShield RAID Manager for details on configuring non-bootable RAID from Windows.

Setting Up the BIOS

- 1 Start your computer, then press Delete to enter the BIOS setup.

The BIOS CMOS Setup Utility window appears.

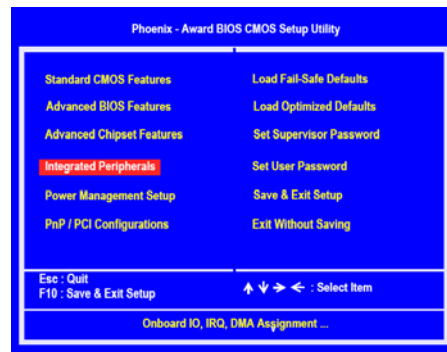

Figure 2.1 BIOS CMOS Setup Utility Main Window

- 2 Use the arrow keys to select Integrated Peripherals (see Figure 2.1), then press Enter.

The Integrated Peripherals window appears.

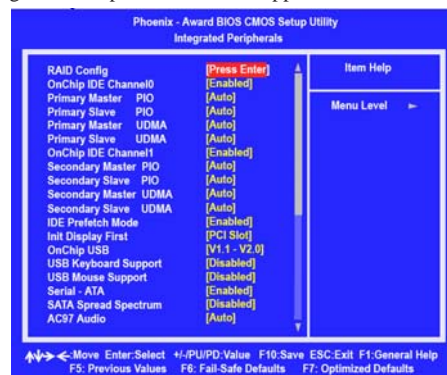

Figure 2.2 Integrated Peripherals Window

NVIDIA RAID Configuration

- Use the arrow keys to select the RAID Config (see Figure 2.2), then press Enter.

The RAID Config window appears.

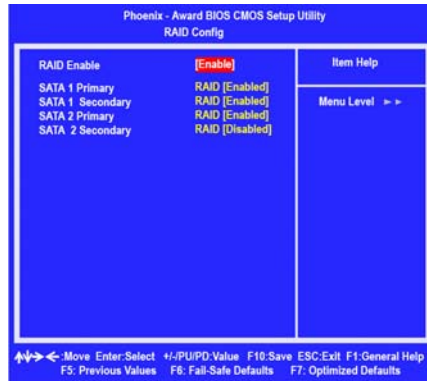

Figure 2.3 RAID Config Window

- From the RAID Config window, globally enable RAID, then enable the SATA ports with disks that you want to use for RAID.

If RAID is enabled globally but not enabled on the individual SATA port, disks on that port can only be used for non-RAID applications.

In the example in Figure 2.3, three SATA ports are enabled, so the non-bootable RAID array can include up to 3 SATA disks. If there is a disk Connected to "SATA 2 Secondary", it can not be used for RAID.

- Press F10 to save the configuration and exit.

The PC reboots.

Installing the NVIDIA RAID Software Under Windows

This section describes how to run the setup application and install the RAID software.

- Start the nForce Setup program to open the NVIDIA Windows nForce Drivers page.

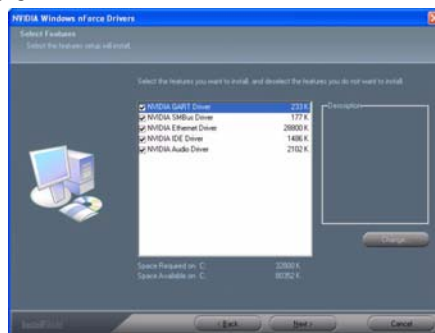

Figure 2.4 nForce Driver Installation Window

NVIDIA RAID Configuration

- 2 Select the modules that you want to install.
Make sure that the “NVIDIA IDE Driver” is selected.
- 3 You must install the NVIDIA IDE driver in order to enable NVIDIA RAID.
If you do not install the NVIDIA IDE driver, NVIDIA RAID will not be enabled.
- 4 Click Next and then follow the instructions. After the installation is completed, be sure to reboot the PC.
- 5 After the reboot, initialize the newly created array.

NVIDIA RAID Configuration

Setting Up a Bootable RAID Array

This section explains how to configure a bootable NVIDIA RAID array.

Setting Up the BIOS

- 1 Start your computer, then press Delete to enter the BIOS setup. The BIOS CMOS Setup Utility screen appears.

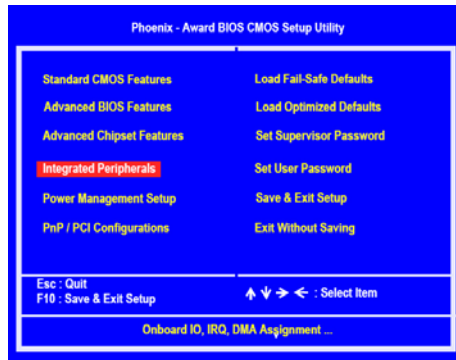

Figure 2.5 BIOS CMOS Setup Utility Main Screen

- 2 Use the arrow keys to select Integrated Peripherals (see Figure 2.5), then press Enter.

The Integrated Peripherals screen (or a screen similar to it) appears.

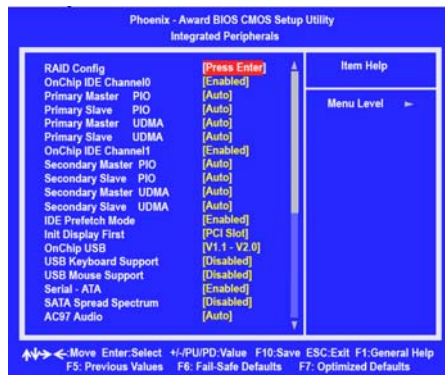

Figure 2.6 Integrated Peripherals Screen

- 3 Use the arrow keys to select the RAID Config (see Figure 2.6).
- 4 Press Enter.

NVIDIA RAID Configuration

The RAID Config window appears.

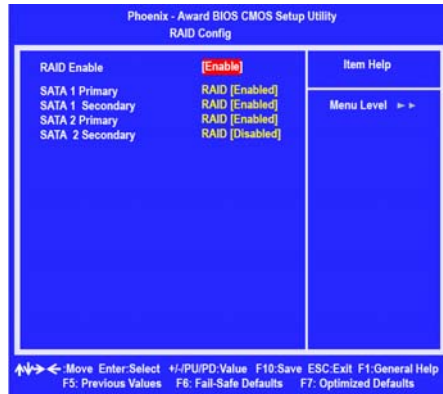

Figure 2.7 RAID Config Screen

- From the RAID Config window, globally enable RAID, then enable the SATA ports with disks that you want to use for RAID.

If RAID is enabled globally but not enabled on the individual SATA port, disks on that port can only be used for non-RAID applications.

In the example in Figure 2.7, three SATA ports are enabled, so the non-bootable RAID array can include up to 3 SATA disks. If there is a disk connected to "SATA 2 Secondary", it can not be used for RAID.

- Press F10 to save the configuration and exit.
The PC reboots.
- Enter the RAID BIOS Setup by pressing F10 when prompted, and proceed to set up the NVIDIA RAID BIOS as described in the next section.

Configuring the NVIDIA RAID BIOS

The NVIDIA RAID BIOS set up lets you choose the RAID type and which hard drives you want to make part of the array.

Entering the RAID BIOS Setup:

- Wait until you see the RAID software prompting you to press F10.

The RAID prompt appears as part of the system POST and boot process prior to loading of the OS. You have a few seconds to press F10 before the screen disappears.

- Press F10.

NVIDIA RAID Configuration

The NVIDIA RAID Utility—Define a New Array screen appears (Figure 2.8).

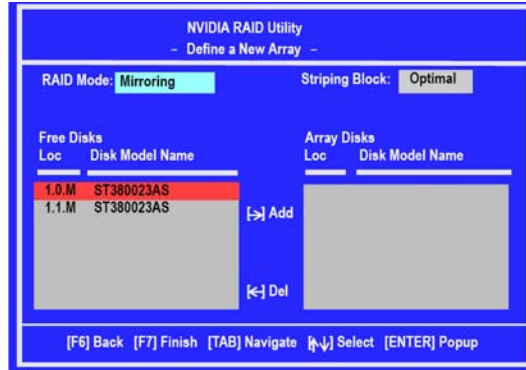

Figure 2.8 NVIDIA RAID Utility

By default, RAID Mode is set to Mirroring and Striping Block is set to Optimal.

Using the Define a New Array Screen

If necessary, press the tab key to move from field to field until the appropriate field is highlighted.

- **Selecting the RAID Mode**

By default, this is set to Mirroring. To change to a different RAID mode, press the down arrow key until the mode that you want appears in the RAID Mode box—either Mirroring, Striping, Spanning, Stripe Mirroring or RAID 5.

Note: Not all RAID levels are supported on all platforms.

- **Selecting the Strping Block Size**

Striping block size is given in kilobytes, and affects how data is arranged on the disk. It is recommended to leave this value at the default Optimal, which is 64KB, but the values can be between 4 KB and 128 KB (4, 8, 16, 32, 64, and 128 KB)

Assigning the Disks

The disks that you enabled from the RAID Config BIOS setup page appear in the Free Disks block. These are the drives that are available for use as RAID array disks.

To designate a free disk to be used as a RAID array disk,

- 1 Tab to the Free Disks section.
The first disk in the list is selected
- 2 Move it from the Free Disks block to the Array Disks block by pressing the right-arrow key (→).
The first disk in the list is moved, and the next disk in the list is selected and ready to be moved.
- 3 Continue pressing the right-arrow key (→) until all the disks that you want to use as RAID array disks appear in the Array Disks block.

NVIDIA RAID Configuration

Figure 2.9 illustrates the Define a New Array screen after two disks have been assigned as RAID1 array disks.

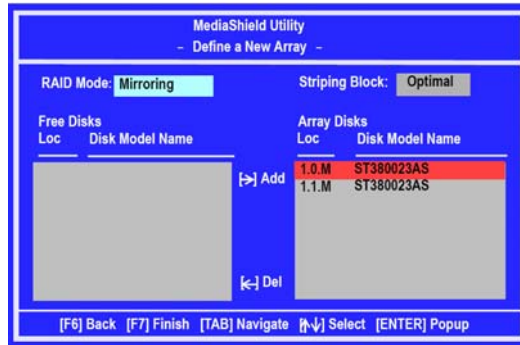

Figure 2.9 MediaShield Utility—Array Disks Assigned

Completing the RAID BIOS Setup

- 1 After assigning your RAID array disks, press F7. The Clear disk array prompt appears.

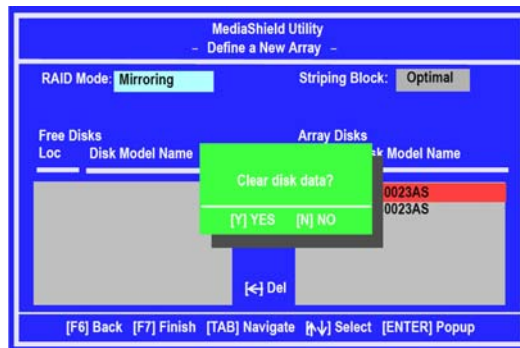

Figure 2.10 Clear Disk Data Prompt

NVIDIA RAID Configuration

- 2 Press Y to clear the disk data.
The Array List screen appears, where you can review the RAID arrays that you have set up.

Boot	Id	Status	Vendor	Array Model Name
Yes	2	Healthy	NVIDIA	MIRROR 74.53G

[Ctrl-X] Exit [Up/Down] Select [B] Set Boot [N] New Array [ENTER] Detail

Figure 2.11 Array List Window

- 3 Use the arrow keys to select the array that you want to set up, then press B to specify the array as bootable.
- 4 Press Enter to view and verify details.
The Array Detail screen appears.

Adapt	Channel	M/S	Index	Disk Model Name	Capacity
1	0	Master	0	ST380023AS	74.56GB
1	1	Master	1	ST380023AS	74.56GB

[R] Rebuild [D] Delete [C] Clear Disk [Enter] Return

Figure 2.12 Array Detail Screen

The Array Detail screen shows various information about the array that you selected, such as Striping Block used, RAID Mode, Striping Width, Disk Model Name, and disk capacity.

- 5 If you want to mark this disk as empty and wipe out all its contents, press C.
- 6 At the prompt, press Y to wipe out all the data, otherwise press N.
- 7 Press Enter again to go back to the previous screen and then press F10 to exit the RAID setup.

NVIDIA RAID Configuration

Installing the RAID Drivers

Your system may come with a Windows install CD that already includes NVIDIA RAID drivers. If so, then this section is not relevant.

If that is not the case (or you are trying to install a new version of Windows), then you will need an NVIDIA RAID driver F6 install floppy. Check to see if one came with your system. If not, you can create one by downloading the appropriate driver package and following the steps in this section.

- 1 Copy all files in "..\IDE\WinXP\sataraid" to a floppy disk. (For Windows 2000, substitute "Win2K" in the path.)
- 2 After you complete the RAID BIOS setup, boot from the Windows CD. The Windows Setup program starts.
- 3 Press F6 and wait a few moments for the Windows Setup screen to appear.



Figure 2.13 Windows Setup—Specify Devices

- 4 Specify the NVIDIA drivers.
 - a Insert the floppy that has the RAID driver, press S, then press Enter.

The following Windows Setup screen appears:

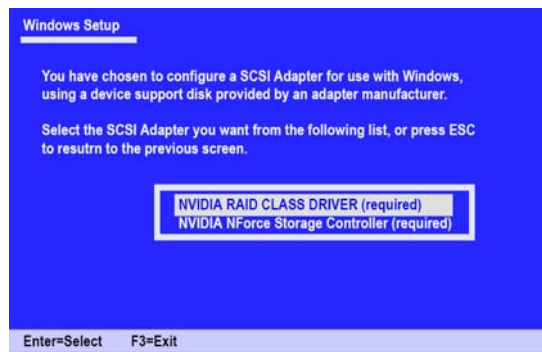

Figure 2.14 Windows Setup—Selected SCSI Adapter
NVIDIA RAID Configuration

- b Select “NVIDIA RAID CLASS DRIVER (required)” and then press Enter.
- c Press S again at the Specify Devices screen, then press Enter.
- d Select “NVIDIA NForce Storage Controller (required)” and then press Enter.

The following Windows Setup screen appears listing both drivers:

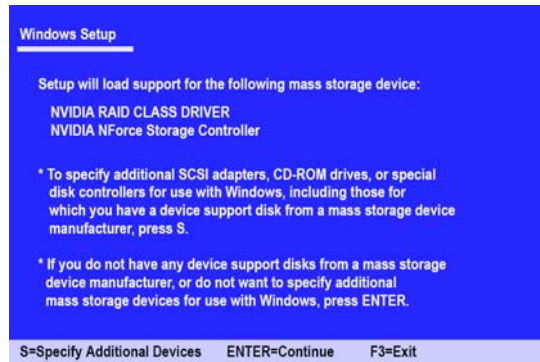

Figure 2.15 Windows Setup—NVIDIA drives listed

- 5 Press Enter to continue with Windows XP Installation.
Be sure to leave the floppy disk inserted in the floppy drive until the blue screen portion of Windows XP installation is completed, then take out the floppy.
 - 6 Follow the instructions on how to install Windows XP.
After Windows XP is completely installed, it is recommended that you install the ForceWare software in order to access the MediaShield RAID Management tool.
- Note:** Each time you add a new hard drive to a RAID array, the RAID driver will have to be installed under Windows once for that hard drive. After that, the driver will not have to be installed.

NVIDIA RAID Configuration