

# KM51PV

## Copyright

All rights are reserved. No part of this publication may be reproduced, transmitted, transcribed, stored in a retrieval system or translated into any language or computer language, in any form or by any means, electronic, mechanical, magnetic, optical, chemical, manual or otherwise, without the prior written permission of the company. Brands and product names are trademarks or registered trademarks of their respective companies.

The vendor makes no representations or warranties with respect to the contents herein and especially disclaim any implied warranties of merchantability or fitness for any purpose. Further the vendor reserves the right to revise this publication and to make changes to the contents herein without obligation to notify any party beforehand. Duplication of this publication, in part or in whole, is not allowed without first obtaining the vendor's approval in writing.

## Trademark

All the trademarks or brands in this document are registered by their respective owner.

## Disclaimer

We make no warranty of any kind with regard to the content of this user's manual. The content is subject to change without notice and we will not be responsible for any mistakes found in this user's manual. All the brand and product names are trademarks of their respective companies.

## FCC Compliance Statement

This equipment has been tested and found to comply with the limits of a Class B digital device, pursuant to Part 15 of the FCC Rules. These limits are designed to provide reasonable protection against harmful interference in a residential installation. This equipment generates, uses and can radiate radio frequency energy and, if not installed and used in accordance with the instructions, may cause harmful interference to radio communications. Operation of this equipment in a residential area is likely to cause harmful interference in which case the user will be required to correct the interference at his own expense. However, there is no guarantee that interference will not occur in a particular installation.

## CE Mark

The device is in accordance with 89/336 ECC-ENC Directive.

Ver: EG102

# KM51PV

nVIDIA® nForce4 C51PV & MCP51  
Supports Socket 939

AMD® Athlon™ 64/ Athlon™ 64 FX/  
Athlon™ 64 x2 Dual-Core Processor

## User Manual

### **Dimensions (Micro-ATX Form-Factor):**

- 220mm x 244mm ( W x L )

### **Operating System:**

- Windows® 2000/ XP

## Things You Should Know

- The images and pictures in this manual are for reference only and may vary from the product you received depending on specific hardware models, third party components and software versions.
- This mainboard contains very delicate IC chips. Always use a grounded wrist strap when working with the system.
- Do not touch any IC chip, lead, connector or other components.
- Always unplug the AC power when you install or remove any device on the mainboard or when configuring pins and switches.

## Packing List

- ◇ KM51PV mainboard
- ◇ FDD Cable
- ◇ HDD Cable
- ◇ SATA Cable
- ◇ I/O Bracket
- ◇ USB Cable (Optional)
- ◇ TV OUT Cable (Optional)
- ◇ SPDIF Cables (Optional)
- ◇ ABS Card (Optional)
- ◇ Mainboard User Manual CD
- ◇ Mainboard Setup Driver CD
- ◇ Mainboard Quick Installation Guide

## Symbols

The following list explains the convention for symbols that will be used throughout this manual:

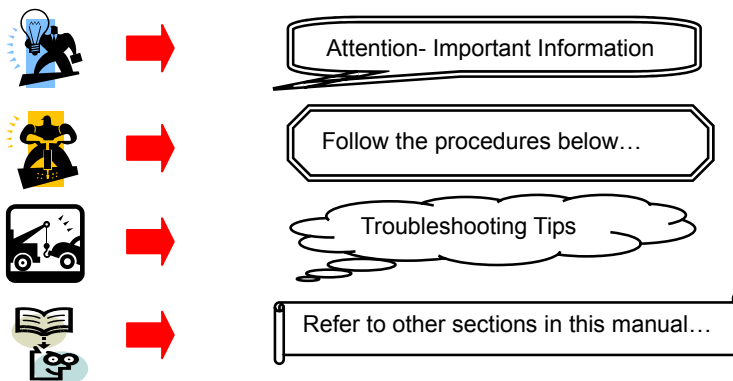

# Table of Contents

<b>CHAPTER 1. GETTING STARTED .....</b>	<b>1</b>
INTRODUCTION.....	1
SPECIFICATION .....	2
CONFIGURATION .....	5
Layout of KM51PV .....	5
HARDWARE INSTALLATION .....	6
CPU Processor Installation.....	6
Memory Installation .....	7
Back Panel Configuration.....	9
Connectors .....	11
Front Panel Headers.....	12
Headers & Jumpers.....	13
Audio Configuration.....	16
Slots .....	17
Power Supply Attachments.....	18
<b>CHAPTER 2. BIOS SETUP.....</b>	<b>19</b>
INTRODUCTION.....	19
KEY FUNCTION.....	19
MAIN MENU .....	20
ADVANCED BIOS FEATURES .....	22
INTEGRATED PERIPHERALS .....	28
POWER MANAGEMENT .....	31
HARDWARE MONITOR .....	33
LOAD DEFAULTS/EXIT MENU .....	33
<b>CHAPTER 3: SOFTWARE SETUP.....</b>	<b>34</b>
<b>CHAPTER 4: TROUBLESHOOTING.....</b>	<b>36</b>
APPENDIX I: SUPER 5.1 CHANNEL AUDIO EFFECT SETUP .....	39
APPENDIX II: RAID SETUP .....	40
APPENDIX III: ABS (ALBATRON BIOS SECURITY) CARD SETUP.....	47

## **INSTALLATION NOTE**

This mainboard complies with the ATX standard, which means the ACPI connector on this board is 2-pin. If the Power LED cable of your case uses a 3-pin adapter, you must use the 2-pin to 3-pin adapter (contained in the packaging).

本主機版之電路設計遵循標準 ATX 規格，標準 ATX 規格的 ACPI 針腳為 2 pin；若機殼面板的 Power LED 連接線為 3 pin 時，請利用隨產品包裝所附的 2 pin 轉 3 pin 連接線來連接。

本メインボードの電路は ATX 規格に基づいて、設計されたものだから、ACPI コネクタは 2-ピンです。ケースの Power LED ケーブルが 3-ピンである場合は、パッケージの中での 2-3 ピンアダプタを使って、LED をこのコネクタに接続してください。

La carte de mère se conforme à ATX norme, signifie que l'adaptateur de ACPI sur cette carte est 2-broche. Si le ACPI câble de votre boîtier d'ordinateur est 3-broche, utilisez l'adaptateur 2-broche vers 3-broche dans le paquet pour le connecter.

Dieses Mainboard stimmt mit dem ATX-Standard überein (d.h. auf der Hauptplatine befindet sich ein 2-poliger ACPI-Anschluss). Falls Ihr Power-LED-Kabel 3-polig ist, benutzen Sie bitte einen 3 poligen zu 2 poligen Zwischenstecker.

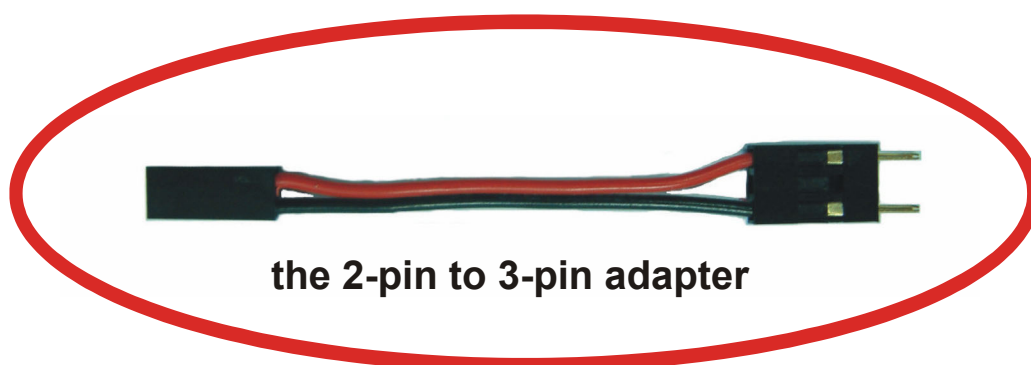

120470017M1N

- ◆ Locate the Power LED cable attached to the case. If the Power LED cable has a 3-pin adapter, you must use the 2-pin to 3-pin adapter which comes with the packaging.



- ◆ The heads of the power cables usually have a triangular mark which indicates the positive electrode(+). Connect the 3-pin end of the adapter to the Power LED cable, matching up the positive electrodes(+).



- ◆ Finally, attach the 2-pin end of the adapter to the ACPI pins on the mainboard, making sure you match up the positive electrodes(+).

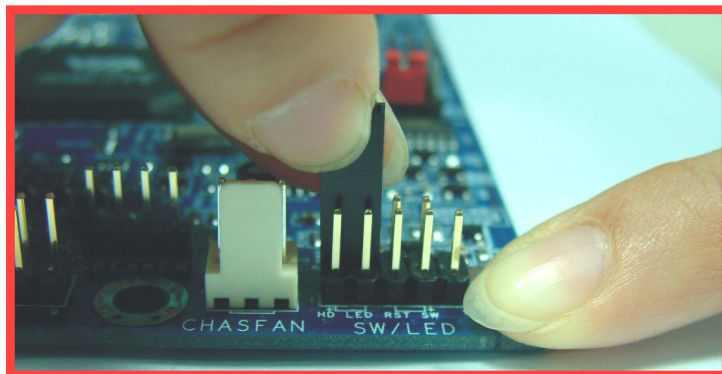

# **Chapter 1. Getting Started**

## **Introduction**

Congratulations on the choosing the KM51PV Mainboard. It is based on the nVIDIA® nForce4 C51PV Northbridge chipset and the nVIDIA® nForce4 MCP51 Southbridge chipset, with possessing integrated graphics feature. The mainboard supports the AMD Athlon™ 64/ Athlon™ 64 FX/ Athlon™ 64 x2 Dual-Core Processor with system bus 1000 MHz (2000 MT/s).

The KM51PV provides four DIMM (Dual In-Line Memory Modules) sockets and which with Dual Channel Technology supported. The sockets allow you to install 184-pin, ECC and non-ECC, and unbuffered DDR400 (PC3200)/ DDR333 (2700)/ DDR266 (PC2100) SDRAMs, and support to install a total memory capacity of 4GB.

This mainboard provide one PCI-E x16 slot and two PCI slots for use with a graphics card or expansion cards which the PCI interface compatible. In addition, one PCI-E x1 slot is provided by the mainboard for use with an expansion card which the PCI-E x1 interface compatible.

The KM51PV provides one floppy disk drive connector that can be used with 360KB/ 720KB/ 1.2MB/ 1.44MB/ 2.88MB drives. It also has two IDE connectors for hard drives supporting Ultra ATA 66/ 100/ 133. In addition, the onboard Serial ATA II comes with four SATA II connectors, which the interface can provide up to 300 Mbps transmission speeds and also support RAID 0/ 1/ 0+1/ JBOD/ 5 mode (**See Appendix II**).

Moreover, the KM51PV provides one VGA connector (=D-Sub connector), one DVI connector, and a maximum of eight USB 2.0/ 1.1 ports that can be set. Several headers are also available on the mainboard for a TV OUT connector, a printer connector, and a COM connector that can be connected additionally with cables and to be set on the case back panel for use.

The onboard AC' 97 sound codec supports high quality 6-channel audio play (Super 5.1 Channel Audio Effect) (**See Appendix I**) and supports the Sony/Philips Digital Interfaces (SPDIF) specifications.

This mainboard also comes with an onboard 10/100 Mbps Ethernet LAN chip. There is a LAN port on the case back panel that you can directly plug into an Internet cable.

In addition, this mainboard supports the ABS (Albatron BIOS Security) card (Optional), which is a small circuit board inserted onto the mainboard providing full backup BIOS functionality in case of BIOS failure or damage during the BIOS flash (**See Appendix III**).

All the information (including hardware installation and software installation) in this manual are for reference only. The contents in this manual may be updated without notice. The company will not assume any responsibility for any errors or mistakes within.

## **Specification**

### **CPU:**

- Supports Socket 939
- Supports AMD Athlon™ 64/ Athlon™ 64 FX/ Athlon™ 64 x2 Dual-Core Processor
- Supports Hyper-Transport™ Link Technology
- Supports system bus 1000 MHz (2000MT/s)

### **Chipset:**

- Northbridge Chipset – nVIDIA® nForce4 C51PV
  - Integrated nVIDIA® Pure Video™ Technology
  - Supports TV Encoder
  - Supports 475 MHz Graphic Clock
  - Supports MPEG-2 (DVD)/ WMV9 (HD-Video) Playback
  - Supports Video Scaling
- Southbridge Chipset – nVIDIA® nForce4 MCP51
- I/O Controller – Winbond® W83627HF-AW
- AC' 97 Audio Codec – Realtek® ALC655
- LAN Controller – Broadcom® AC 131

### **Memory:**

- Four DIMM sockets with Dual Channel Technology supported, and also support a total memory capacity of 4GB
- Supports to use the 184-pin, ECC and non-ECC, and unbuffered DDR400 (PC3200)/ DDR333 (PC2700)/ DDR266 (PC2100) SDRAMs

### **Slots:**

- One PCI-E x16 slot
- One PCI-E x1 slot
- Two PCI slots

### **FDD Connector:**

- One floppy disk drive connector, supports up to two FDDs
- Supports 360KB/ 720KB/ 1.2MB/ 1.44MB/ 2.88MB

### **IDE Connector:**

- Two IDE connectors, support up to four IDE devices
- Supports Ultra ATA 33/ 66/100/133
- Supports high capacity hard disk drives

### **Serial ATA II Connector:**

- Four SATA II connectors, support up to four SATA II HDDs
- Supports SATA 2.0 specification and provides 300 Mbps transmission speeds
- Supports RAID 0/1/ 0+1/ JBOD/ 5 mode

### **I/O facility Connectors:**

- One PS/2 mouse port and one PS/2 keyboard port
- One DVI connector
- One VGA connector (=D-Sub connector)
- Headers on the mainboard are available for setting a TV Out connector, a Printer connector, and a COM connector additionally on the case back panel for use

### **USB Ports:**

- Six onboard USB 2.0/ 1.1 ports
- One front USB header comes with this mainboard, and supports a maximum of two additional USB ports to be set

### **Onboard AC' 97 Sound Codec:**

- High performance Codec with high S/N ratio (>90 db)
- Compliant with AC' 97 2.3 specification
- Support 6-channel playback capability (Super 5.1 Channel Audio Effect)
- Support 3D stereo enhancement
- Support Sony/ Philips Digital Interfaces (S/PDIF) functionality

### **Onboard LAN Chip:**

- Supports 10/100 Mbps Ethernet LAN
- Supports nVIDIA® Active Armor™, it provides advanced data packet inspection
- Supports nVIDIA® Firewall™, it protects your system from intruders

### **BIOS:**

- Phoenix-Award™ BIOS
- Supports APM1.2
- Supports ACPI2.0 power management

### **Green Function:**

- Supports Phoenix-Award™ BIOS power management function
- Supports system-wake-from-power-saving-mode by keyboard or mouse touching

### **Hardware Monitor Function:**

- Monitors CPU/ Chassis Fan Speed
- Monitors CPU and system temperatures
- Monitors system voltages

### **Watch Dog Timer:**

- This function is used for detecting the system hangs during the POST stage due to conflicts resulting from changing the system BIOS settings. Once the problem is detected, the system will reset the configurations and reboot the system within five seconds.

### **ABS (Albatron BIOS Security):**

- Supports ABS Card (Optional)
- Supports BIOS backup

# Configuration Layout of KM51PV

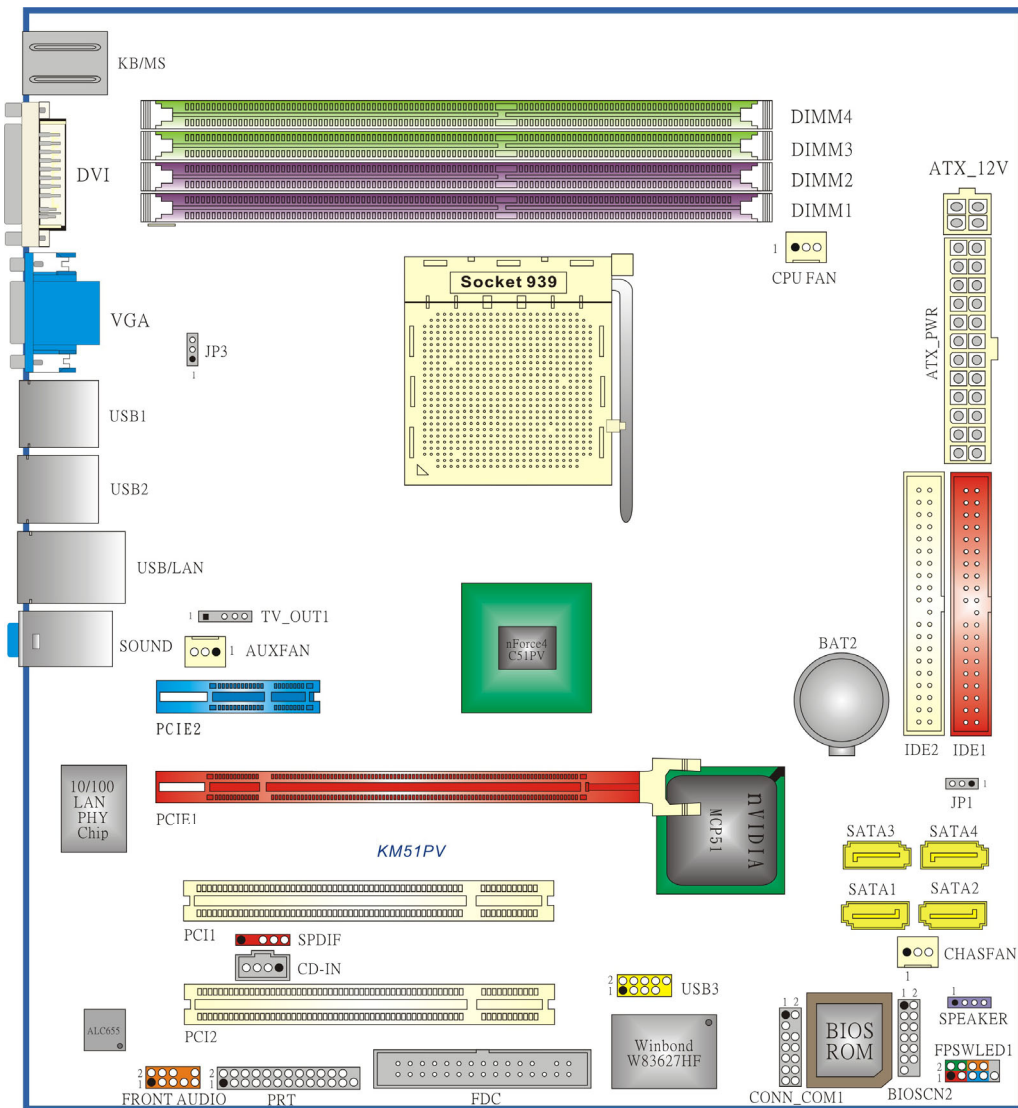

## Hardware Installation

This section will assist you in quickly installing your system hardware. Wear a wrist ground strap before handling components. Electrostatic discharge may damage your system components.

### CPU Processor Installation

This mainboard supports AMD Athlon™ 64/ Athlon™ 64 FX/ Athlon™ 64 x2 Dual-Core processor and uses a Socket 939. Before building your system, we suggest you visit the AMD website and review the processor installation procedures. <http://www.amd.com>

#### CPU Socket 939 Configuration Steps:

1. Locate the CPU socket on your mainboard and nudge the locking lever away from the socket. Then lift the lever to a 90-degree angle.
2. On the socket, locate the corner which has the “diagonally cut-corner” on the rectangular shaped pattern of pinholes (see diagram below-left). Match that corner with the “gold triangle” on the CPU (see diagram below-right) and lower the CPU onto the socket. The bottom of the CPU should be flush with the face of the socket.

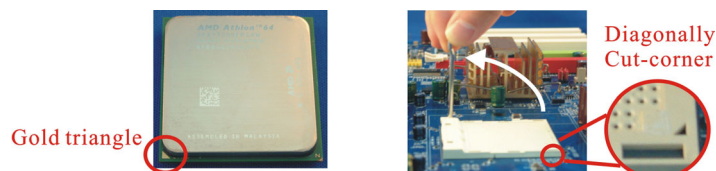

3. Lower the lever until it snaps back into position. This will lock down the CPU.

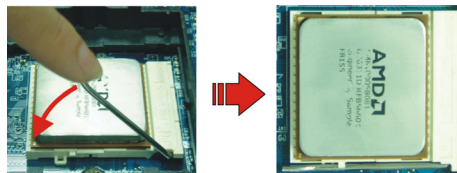

4. Smear thermal grease on top of the CPU. Lower the CPU fan onto the CPU and use the clasps on the fan to attach it to the socket. Finally, extend the power cable from the fan and insert it onto the “CPUFAN” adapter.

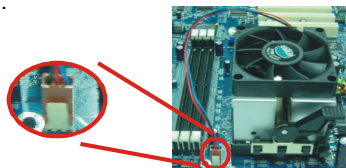

#### Attention

DO NOT touch the CPU pins in case they are damaged. Also, make sure that you have completed all installation steps before powered on the system. Finally, double-check that the cooling fan is properly installed and the CPU fan power cord is securely attached, in case your CPU and other sensitive components are damaged because of high temperatures.

### FAN Headers: CPUFAN, AUXFAN, CHASFAN

There are three fan headers available for cooling fans. The cooling fans play an important role in maintaining ambient temperatures in your system. The CPUFAN header is attached with a CPU cooling fan. The CHASFAN and AUXFAN headers are attached with other cooling fans.

 <b>CPUFAN/ AUXFAN/ CHASFAN</b>	Pin	Assignment
	1	Ground
	2	Power (+12V)
	3	FAN RPM rate sense



**Attention**

You can avoid damaging your CPU due to high temperatures with proper cooling equipment. It is recommended that attach a cooling fan on top of your CPU. Use the CPUFAN header to attach the fan cord.  
On most fan power cord, the black wire of the fan cable is the “ground” and should be attached to pin-1 of the header.

### Memory Installation: DIMM1/2/3/4

The KM51PV provides four DIMM (Dual In-Line Memory Modules) sockets and which with Dual Channel Technology supported. The sockets allow you to install 184-pin, ECC and non-ECC, and unbuffered DDR400 (PC3200)/ DDR333 (2700)/ DDR266 (PC2100) SDRAMs, and support to install a total memory capacity of 4GB.

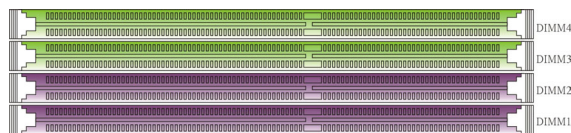

**Enable Dual-Channel functionality:**

1. If you need to install two memories, use either DIMM1 socket & DIMM2 socket together or DIMM3 socket & DIMM4 socket together; or use all four DIMM sockets. If you need to install only one memory, use either DIMM1 socket or DIMM3 socket.
2. If you need to install two or more memories, it is recommended that install identical memory specifications as list below to achieve the best results.

- Same density (i.e., 128MB, 256MB, etc.)
- Same DRAM technology
- Same DRAM bus width (i.e., x8, x16, etc.)
- Same DDR speed
- Same brand name
- Same timing specifications

## Mainboard KM51PV

Please refer the table below to install memories:

Data Bus	DIMM 1	DIMM 2	DIMM 3	DIMM 4	Maximum DRAM SPEED	
					1T	2T(Default)
<b>64-bits Single channel</b>	single side	X	---	X	DDR400	DDR400
	Double side	X	---	X	DDR400	DDR400
	---	X	single side	X	DDR333	DDR333
	---	X	Double side	X	DDR400	DDR400
	single side	X	single side	X	DDR333	DDR400
	single side	X	Double side	X	DDR200	DDR400
	Double side	X	single side	X	DDR200	DDR400
	Double side	X	Double side	X	DDR200	DDR333
<b>128-bits Dual channel</b>	single side	single side	---	---	DDR400	DDR400
	Double side	Double side	---	---	DDR400	DDR400
	---	---	single side	single side	DDR333	DDR333
	---	---	Double side	Double side	DDR400	DDR400
	single side	single side	single side	single side	DDR333	DDR400
	single side	single side	Double side	Double side	DDR200	DDR400
	Double side	Double side	single side	single side	DDR200	DDR400
	Double side	Double side	Double side	Double side	DDR200	DDR333

**NOTE :** 1T & 2T(default) can be switched in BIOS setting.

### Memory Setup Steps:

The following instructions explain how to install memories onto the DIMM sockets for this mainboard.

1. Pull the white plastic tabs at both ends of the socket away.

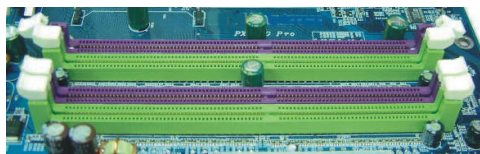

2. Align a memory on the socket such that the notch on the memory matches the break on the socket.

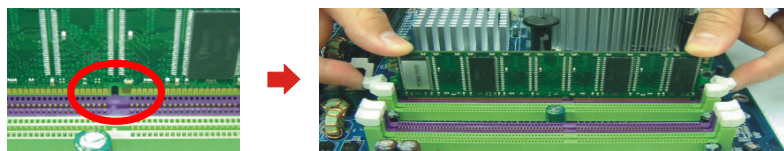

## Mainboard KM51PV

3. Lower the memory vertically into the socket and press firmly by using both thumbs until the memory snaps into place.

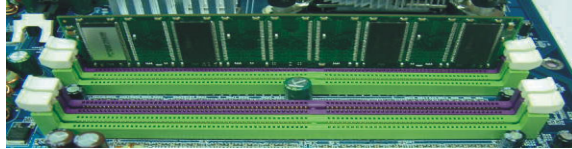

4. Repeat steps 1, 2 & 3 for the remaining memory and DIMM sockets setup.

\* The pictures shown above are for reference only. The actual installation may vary depending on models.

## Back Panel Configuration

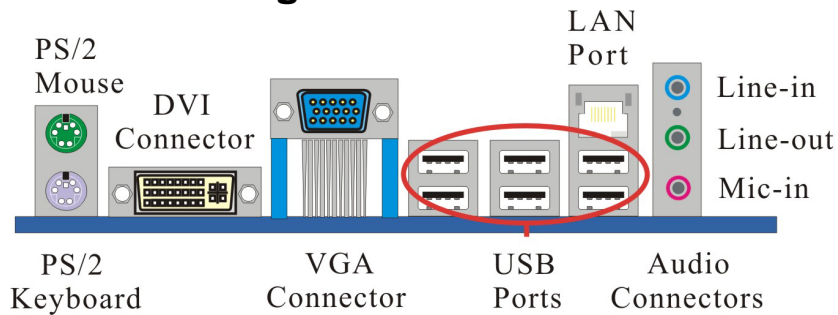

### PS/2 Mouse & PS/2 Keyboard Ports: KB/MS

This mainboard provides a standard PS/2 mouse port and a PS/2 keyboard port. The pin assignments are described below.

#### PS/2 Mouse

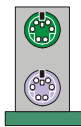

#### PS/2 Keyboard

Pin	Assignment	Pin	Assignment
1	Data	4	+5 V (fused)
2	N/A	5	Clock
3	Ground	6	N/A

**DVI & VGA Connectors: DVI, VGA**

The mainboard provides one DVI connector and one VGA connector (= D-Sub connector) on the case back panel.

DVI connector delivers the digital signals, and is able to connect with LCD display, plasma display, or other display device which with the DVI interface compatible.

VGA connector (= D-Sub connector) delivers the analog signals, and is able to connect with traditional CRT display, flat display, or other display device which with the D-Sub interface compatible.

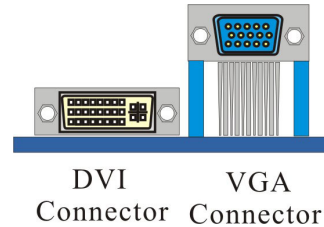

**USB & LAN Ports: USB1, USB2, USB/LAN**

There are six USB 2.0/ 1.1 ports on the back panel. These USB ports are used to attach with USB devices, such as keyboard, mice and other USB supported devices. There is also a 10/100 Mbps Ethernet LAN port available for you to attach an Internet cable.

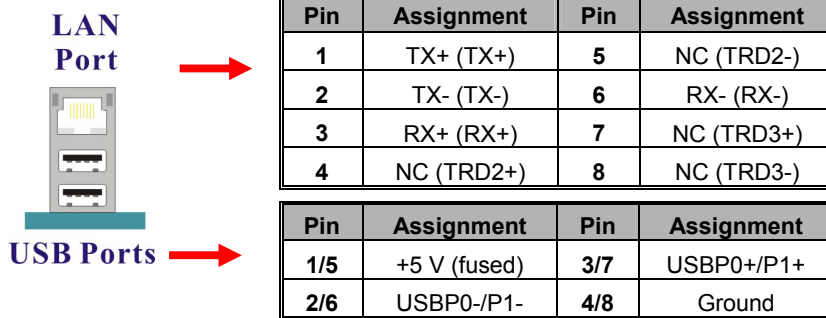

**Audio Ports: Sound**

This mainboard provides three audio ports, the Mic-in, Line-in and Line-out. These are the standard audio ports that provide basic audio function.

**Line-In (Blue)**

This port is for audio input and connects to external audio devices such as CD player, tape player, etc. When the Super 5.1 Channel Audio Effect is enabled, this port will output audio for the rear speakers.

**Line-Out (Green)**

This port is an output audio port used for connecting to speakers or a headset. When the Super 5.1 Channel Audio Effect is enabled, this port will output audio for the front speakers.

**Mic-In (Pink)**

This port is for connecting to a microphone. When the Super 5.1 Channel Audio Effect is enabled, this port will output audio for your subwoofer/center speakers.

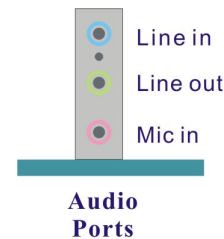

This mainboard supports Super 5.1 Channel Audio Effect which allows you to transform your 2 speaker audio system into a 6 speaker audio system. See **Appendix I** for more information.

## Connectors

### Floppy Disk Drive Connector: FDC

The mainboard provides a standard floppy disk drive connector (FDC) that supports 360KB/ 720KB/ 1.2MB/ 1.44MB/ 2.88 MB floppy disk drives using a FDD ribbon cable.

### Hard disk drive Connectors:

The mainboard provides two IDE connectors that support Ultra ATA 66/100/ 133 IDE devices. You can attach a maximum of four IDE devices, such as hard disk drive (HDD), CD-ROM, DVD-ROM, etc. using IDE ribbon cables.

#### Primary IDE Connector: IDE1

In general, two IDE devices can be attached onto one IDE connector. If you attach two IDE HDDs, you must configure one drive as the master and the other one as the slave.

#### Secondary IDE Connector: IDE2

The IDE2 connector can also be attached with two IDE HDDs, and remember to configure one drive as the Master and the other one as the Slave as well. In addition, it is recommended that attach the optical devices such as CD-ROM, DVD-ROM, etc. onto this IDE2 connector.

### SATA II Connector: SATA1/ SATA2/ SATA3/ SATA4

The four SATA II connectors support 300 Mbps transmission speeds and RAID 0/1/ 0+1/ JBOD/ 5 mode. One SATA connector only can attach one SATA HDD of each time using SATA cables.

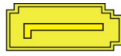
 SATA1~4	Pin	Assignment	Pin	Assignment
	1	Ground	2	TX+
	3	TX-	4	Ground
	5	RX-	6	RX+
	7	Ground		



This mainboard supports RAID 0/1/0+1/JBOD/5 mode, refer **Appendix II** for more information.



#### Attention

The FDD/IDE cable is designed and should be attached with a specific direction. One edge of the cable will usually in color such as red, to indicate that should line up with the header pin-1.

## Front Panel Headers: FPSWLED1, SPEAKER

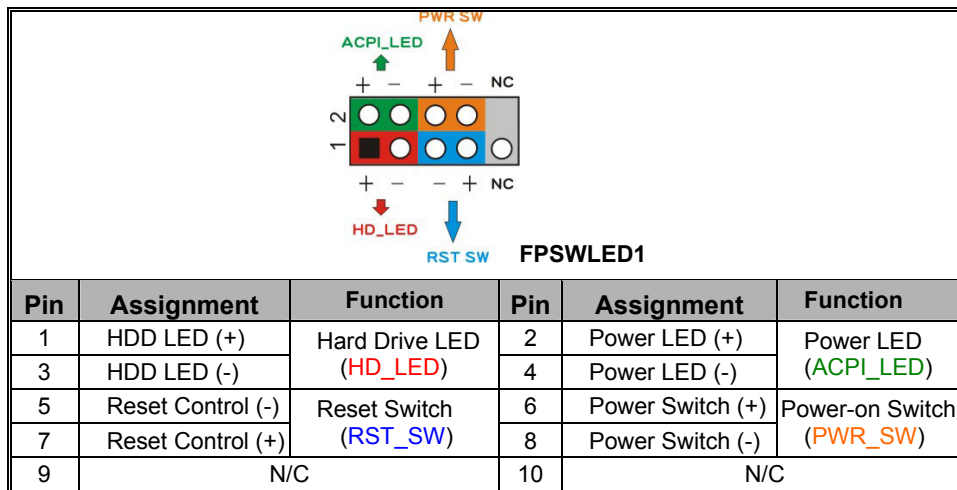

### Hard Drive LED Header (Red): HD\_LED

If your case front panel has a hard drive LED cable, attach it to this header. The LED will flicker when there is hard disk drive activity.

### Reset Switch Header (Blue): RST\_SW

This header can be attached to a momentary SPST switch (reset button) cable on your case front panel. The switch is normally left open. When the switch closed, it will cause the mainboard to reset and run the POST (Power-On Self Test).

### Power-on Switch Header (Orange): PWR\_SW

This header can be attached to a power switch cable on your case front panel. You can turn your system on or off by pressing the button attached to this power switch cable.

### Power LED Header (Green): ACPI\_LED

Attach the power LED cord from the case front panel onto this header, then the power LED will illuminate while the system is powered on.

### Speaker Header (Purple): SPEAKER

A speaker cable on your case front panel can be attached to this header. When you reboot the computer, this speaker will issue a short audible (beep). If there are problems during the Power On Self-Test, the system will issue an irregular pattern of audible beeps through this speaker.

Pin	Assignment	Pin	Assignment
1	PC_BEEP	2	N/C
3	Ground	4	+5V

## Headers & Jumpers

### Front USB Header: USB3

This mainboard provides six onboard USB 1.1/2.0 ports (back panel) that attach to USB devices. There is one additional USB header that can be connected by a cable to two more USB ports on your case front panel giving you a possible 8 USB ports.

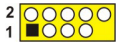
 <p><b>USB3</b></p>	Pin	Assignment	Pin	Assignment
	1	+5V (fused)	2	+5V (fused)
	3	USB-	4	USB-
	5	USB+	6	USB+
	7	Ground	8	Ground
	9	Key	10	N/A



#### Attention

If you are using a USB 2.0 device with Windows 2000/XP, you will need to install the USB 2.0 driver from the Microsoft® website. If you are using Service pack 1 (or later) for Windows® XP, and using Service pack4 (or later) for Windows® 2000, you will not have to install the driver.

### TV OUT Header: TV\_OUT1

Attach the TV OUT cable (Optional) which the product provided onto this header. Then through attaching the cable of TV devices onto the S-Video connector of TV out cable, the TV is able to use as a monitor display.

 <p><b>TV_OUT1</b></p>			
Pin	Assignment	Pin	Assignment
1	Ground	2	Key
3	PB OUT	4	C OUT
5	Y OUT		



**Serial Interface Header: CONN\_COM1**

This mainboard provides a CONN\_COM1 header for you connecting an additional serial connector on your case back panel. Attach the cable of serial connector (Optional) onto this header, then you can use the serial connector connecting with a mic, modem or other peripheral device.

 <b>CONN_COM1</b>	Pin	Assignment	Pin	Assignment
	1	+12V	2	+5V
3	-12V	4	Key	
5	DCD0-	6	SIN0	
7	SOUT0	8	DTR0-	
9	Ground	10	DSR0-	
11	RTS0-	12	CTS0-	
13	RI0-	14	RI-	



**Printer Interface Header: PRT**

This mainboard provides a PRT header for you connecting an additional printer connector on your case back panel. Attach the cable of printer connector (Optional) onto this header, then you can use the printer connector connecting with a printer.

 <b>PRT</b>	Pin	Assignment	Pin	Assignment
	1	RSTB-	2	RPDR0
3	RPDR1	4	RPDR2	
5	RPDR3	6	RPDR4	
7	RPDR5	8	RPDR6	
9	RPDR7	10	ACK-	
11	BUSY	12	PE	
13	SLCT	14	RAFD-	
15	ERR-	16	RINIT_P-	
17	RSLIN-	18	Ground	
19	Ground	20	Ground	
21	Ground	22	Ground	
23	Ground	24	Ground	
25	Ground	26	Key	

### USB Power Selection Header: JP3



USB devices attached to the back panel USB ports can awaken the system from sleep mode. In order to enable this functionality, you must adjust the jumper caps on JP3 header for +5V or +5VSB mode depending on which USB port that the USB device is attached to.

JP3	Assignment	Assignment
 Pin 1-2 Close	+5V	S1 sleep mode (CPU stopped, DRAM refreshed, system running in low power mode)
 Pin 2-3 Close	+5VSB	S3/S4/S5 sleep modes (no power to CPU, DRAM in slow refresh, power supply in reduced power mode)

**Note:** Close stands for putting a jumper cap onto two header pins.

### Clear CMOS Jumper: JP1

The “Clear CMOS” function is used when you are unable boot your system and need to reset the BIOS settings (CMOS settings) back to the manufacturer’s original settings. This is also a way to reset the system password if you have forgotten it.

JP1	Assignment
 Pin 1-2 Close	Normal (Default)
 Pin 2-3 Close	Clear CMOS Data

**Note:** Close stands for putting a jumper cap onto two header pins.



The following steps explain how to reset your CMOS configurations when you forgot a system password.

1. Turn off your system and disconnect the AC power cable.
2. Set JP1 header to OFF (2-3 Closed).
3. Wait several seconds.
4. Set JP1 header to ON (1-2 closed).
5. Connect the AC power cable and turn on your system.
6. Reset your new password.

## Audio Configuration

### CD-ROM Audio-In Connector: CD-IN

The CD-IN connector is used to attach an audio cable to audio devices such as CD-ROMs, DVD-ROMs etc.

 <p>CD-IN</p>	Pin	Assignment
	1	Left channel input
	2	Ground
	3	Ground
4	Right channel input	

### SPDIF Header: SPDIF

S/PDIF is a recent audio transfer file format, which provides high quality audio using optical fiber and digital signals. This mainboard is capable to deliver audio output and receive audio input through the SPDIF header. One way you would use this header is by using an SPDIF bracket (optional) and attaching its cord onto this SPDIF header. The RCA or TOS-Link connectors will be provided on the bracket and which are convenient you to output or input audio format files between your system and the SPDIF styled devices.

 <p>SPDIF</p>			
Pin	Assignment	Pin	Assignment
1	+5V	2	Key
3	SPDIF out	4	Ground
5	SPDIF in		

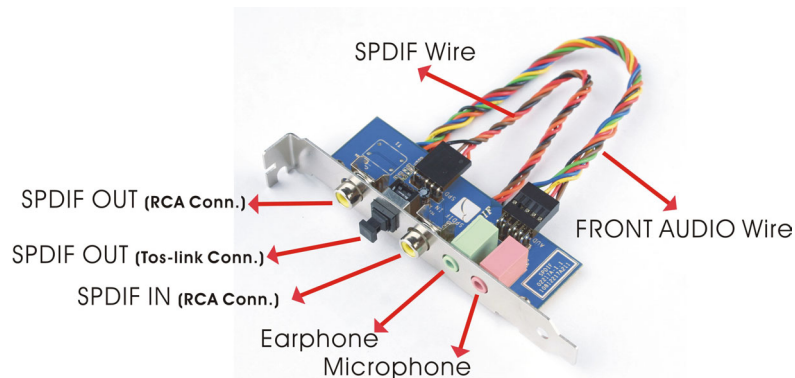

**Front Audio Connector: FRONT AUDIO**

If your case front panel has audio ports, you can connect them to the Front Audio Header of this mainboard. First, you must remove the jumper caps on this header and then attach the cables from the front panel to the pins on this header. You can use both the front panel and back panel audio simultaneously. If you are not using front panel audio ports, leave the jumper caps on the header pins (Note: pins 5&6, 9&10, 11&12, and 13&14) to avoid problems with the back panel audio ports.

 <b>FRONT AUDIO</b>			
Pin	Assignment	Pin	Assignment
1	Mic in/center	2	Ground
3	Mic_VREF	4	Audio power +5V
5	Front out_R	6	Rear out_R
7	N/C	8	Key
9	Front out_L	10	Rear out_L

**Slots**

PCI Slots PCI-Express x16/x1 Slot

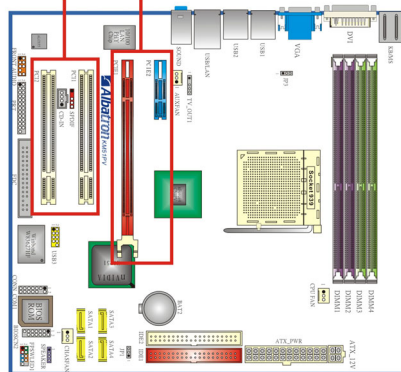

**PCI-Express x16 Slot: PCIE1**

This mainboard is able to install a graphics card which the PCI-Express x16 interface compatible to this PCIE1 slot.

**PCI-Express x1 Slot: PCIE2**

This mainboard is able to install an expansion card which the PCI-Express x1 interface compatible such as network card, SCSI card, etc. to this PCIE2 slot.

**PCI Slots: PCI1, PCI2**

PCI stands for Peripheral Component Interconnect and is a bus standard for installing expansion cards such as network card, SCSI card, etc. to these PCI slots.

## Power Supply Attachments

### ATX Power Connector: ATX\_PWR, ATX\_12V

This mainboard provides two ATX power connectors, a 24-pin ATX\_PWR connector and a 4-pin ATX\_12V connector. You must use a power supply that has both of these connectors and both connectors must be attached before the system is powered on. These power connectors support several power management functions such as the instant power-on function. The connector pins are described below.

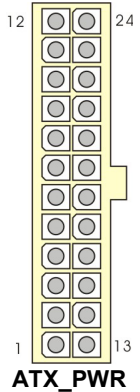
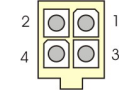
 <p><b>ATX_PWR</b></p>	<b>Pin</b>	<b>Assignment</b>	<b>Pin</b>	<b>Assignment</b>
	1	+3.3V	13	+3.3V
	2	+3.3V	14	-12V
	3	Ground	15	Ground
	4	+5V	16	PS_ON
	5	Ground	17	Ground
	6	+5V	18	Ground
	7	Ground	19	Ground
	8	PW_ON	20	-5V
	9	+5V standby voltage	21	+5V
	10	+12V	22	+5V
	11	+12V	23	+5V
12	+3.3V	24	Ground	
 <p><b>ATX_12V</b></p>	<b>Pin</b>	<b>Assignment</b>	<b>Pin</b>	<b>Assignment</b>
	1	+12V	3	Ground
2	+12V	4	Ground	



#### Attention

In general, power cords are designed and should be attached with a specific direction. The black wire of the power cord is Ground and should be attached onto the header location of Ground.

## **Chapter 2. BIOS Setup**

### **Introduction**

This section describes PHOENIX-AWARD™ BIOS Setup program which resides in the BIOS firmware. The Setup program allows users to modify the basic system configuration. The configuration information is then saved to CMOS RAM where the data is sustained by battery after power-down.

The BIOS provides critical low-level support for standard devices such as disk drives, serial ports and parallel ports. As well, the BIOS control the first stage of the boot process, loading and executing the operating system.

The PHOENIX-AWARD™ BIOS installed in your computer system's ROM is a custom version of an industry standard BIOS. This means that it supports the BIOS of AMD based processors.

This version of the PHOENIX-AWARD™ BIOS includes additional features such as virus and password protection as well as special configurations for fine-tuning the system chipset. The defaults for the BIOS values contained in this document may vary slightly with the version installed in your system.

### **Key Function**

In general, you can use the arrow keys to highlight options, press <Enter> to select, use the <PgUp> and <PgDn> keys to change entries, press <F1> for help and press <Esc> to quit. The following table provides more detail about how to navigate within the BIOS Setup program.

<b>Keystroke</b>	<b>Function</b>
Up arrow	Move to previous option
Down arrow	Move to next option
Left arrow	Move to the option on the left (menu bar)
Right arrow	Move to the option on the right (menu bar)
Esc	Main Menu: Quit without saving changes Submenus: Exit Current page to the next higher level menu
Move Enter	Move to the option you desire
PgUp key	Increase the numeric value or enter changes
PgDn key	Decrease the numeric value or enter changes
+ Key	Increase the numeric value or enter changes
- Key	Decrease the numeric value or enter changes
Esc key	Main Menu – Quit and do not save changes into CMOS Status Page Setup Menu and Option Page Setup Menu – Exit Current page and return to Main Menu
F1 key	General help on Setup navigation keys
F5 key	Load previous values from CMOS
F6 key	Load the defaults from BIOS default table

## Main Menu

When you enter the PHOENIX-AWARD™ BIOS Utility, the Main Menu will appear on the screen. The Main menu allows you to select from several configuration options. Use the left/right arrow keys to select a particular configuration screen from the top menu bar or use the down arrow key to access and configure the information below.

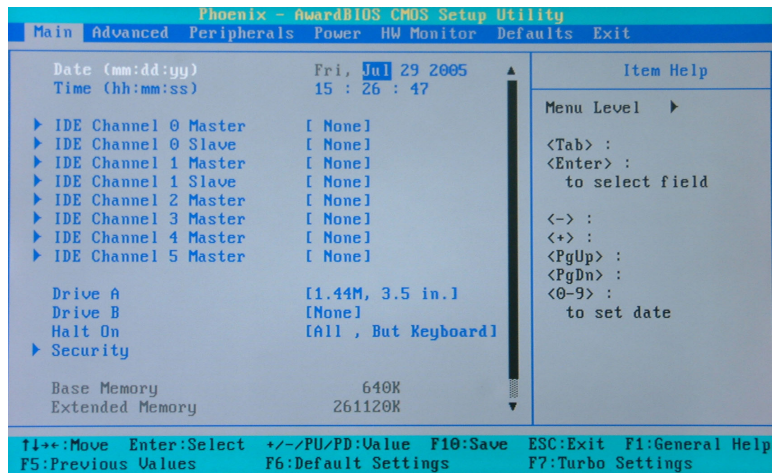

## Main Menu Setup Configuration Options

<b>Item</b>	<b>Options</b>	<b>Description</b>
<b>Date</b>	mm dd yyyy	Set the system date. Note that the 'Day' automatically changes when you set the date.
<b>Time</b>	Hh: mm: ss	Set the current time of the system.
<b>IDE Primary Master</b>	Options contained in sub menu.	Press <Enter> to enter the sub menu.
<b>IDE Primary Slave</b>	Options contained in sub menu.	Press <Enter> to enter the sub menu.
<b>IDE Secondary Master</b>	Options contained in sub menu.	Press <Enter> to enter the sub menu.
<b>IDE Secondary Slave</b>	Options contained in sub menu.	Press <Enter> to enter the sub menu.
<b>IDE Channel 2/3/4/5 Master</b>	Options contained in sub menu.	Press <Enter> to enter the sub menu.
<b>Drive A</b>  <b>Drive B</b>	360K, 5.25 in 1.2M, 5.25 in 720K, 3.5 in 1.44M, 3.5in 2.88M, 3.5 in None	Select the type of floppy disk drive installed in your system.
<b>Halt On</b>	All Errors No Errors All, but Keyboard All, but Diskette All, but Disk/ Key	Select the situation in which you want the BIOS to stop the POST process and notify you.
<b>Security</b>	Options contained in sub menu.	Press <Enter> to enter the sub menu.
<b>Base Memory</b>	N/A	Displays the amount of conventional memory detected during boot up.
<b>Extended Memory</b>	N/A	Displays the amount of extended memory detected during boot up.
<b>Total Memory</b>	N/A	Displays the total memory available in the system.

## Advanced BIOS Features

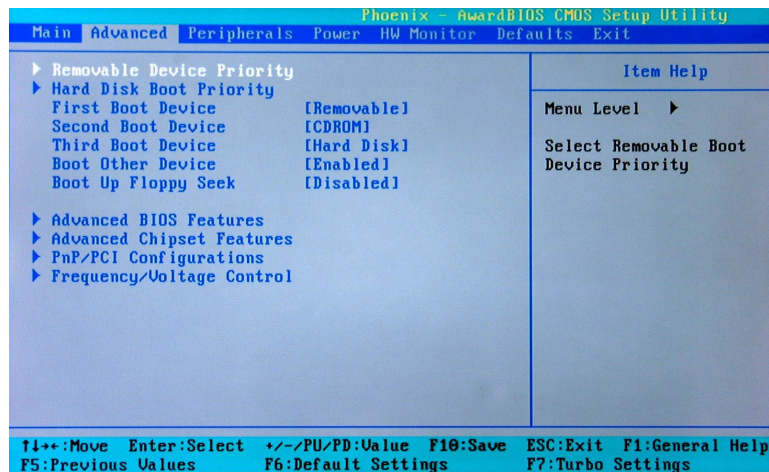

### Removable Device Priority

Select removable device boot priority.

### Hard Disk Boot Priority

Select hard disk drive boot priority.

### First /Second/Third Boot Device

Select the order in which devices will be searched in order to find a boot device.

Options: Removable (default for first boot device), CD ROM (default for second boot device), Hard Disk (default for third boot device), NVIDIA Boot Age, Disabled.

### Boot Other Device

This setting allows the system to try to boot from other devices if the system fails to boot from the 1st/ 2nd/ 3rd boot devices.

Options: Enabled (Default), Disabled.

### Boot Up Floppy Seek

When Enabled, the BIOS tests (seeks) the floppy drives to determine whether they have 40 or 80 tracks. Only 360 KB floppy drives have 40 tracks. Drives with 720 KB, 1.2 MB and 1.44 MB drive capacities have 80 tracks. Because very few modern PCs have 40-tracks floppy driver, we recommend that you set this option to "Disabled".

Options: Enabled, Disabled (Default).

## **Advanced BIOS Features**

### **Virus Warning**

This option allows you to choose the Virus Warning feature for IDE Hard Disk boot sector protection. If this function is enabled and a program attempts to write data into this area, BIOS will display a warning message on the screen and sound an audio alarm (beep).

Options: Disabled (Default), Enabled.

### **CPU Internal Cache**

Make CPU internal cache active or inactive. System performance may degrade if you disable this item.

Options: Enabled (Default), Disable.

### **External Cache**

This option allows you to enable or disable "Level 2" secondary cache on the CPU to enhance performance. Options: Enabled (Default), Disabled.

### **Quick Power On Self Test**

It allows the system to skip certain tests while booting. This will speed up the boot process.

Options: Enabled (Default), Disabled.

### **Swap Floppy Drive**

If the system has two floppy drives, choose "Enabled" to assign physical drive B to logical drive A and vice-versa.

Options: Disabled (Default), Enabled.

### **Boot Up NumLock Status**

Determines the initial power-on state for NumLock.

Options: On (Default) Numpad keys are number keys.

Off Numpad keys are arrow keys.

### **Typematic Rate Setting**

When the options "Typematic Rate," and "Typematic Delay" are configured, the Typematic Rate determines the keystroke repeat rate used by the keyboard controller.

Options: Disabled (Default), Enabled

### **Typematic Rate (Chars/Sec)**

This option determines how many characters per second are generated when a key is held down.

Options: 6 (Default), 8, 10, 12, 15, 20, 24, 30.

### **Typematic Delay (Msec)**

This option represents the delay value before keystrokes begin to repeat.

Options: 250 (Default), 500, 750, 1000.

**APIC Mode**

APIC stands for Advanced Programmable Interrupt Controller, and is used to extend the number of available IRQs available in order to avoid sharing conflicts.

Options: Disabled, Enabled (Default).

**MPS Version Control For OS**

The 1.1 version is the older version that supports 8 more IRQs in the Windows NT environment. Choose the new 1.4 version for Windows 2000 and Windows XP.

Options: 1.4 (Default), 1.1.

**OS Select For DRAM > 64MB**

Select "OS2" only if you are running the OS/2 operating system with greater than 64 MB of RAM.

Options: Non-OS2 (Default), OS2.

**HDD S.M.A.R.T. Capability**

The SMART (Self Monitoring Analysis and Reporting Technology) technology enables a PC to attempt to predict the possible failure of storage drives.

Options: Disabled (Default), Enabled.

**Small LOGO (EPA) Show**

This option allows you to show or hide the small LOGO EPA.

Options: Disabled (Default), Enabled.

**Advanced Chipset Features**

**DRAM Configuration**

**Timing Mode**

This option determines DRAM clock/ timing using SPD or manual configuration.

Make sure your memory module has SPD (Serial Presence Data) if you want to use the "By SPD" option.

Options: Auto (Default), Manual.

**Memclock index value (Mhz)**

This item allows you to select the memory clock. When it set to "auto", the system will automatically detect the memory clock. Options: 200 (Default), 100, 133, 166.

**CAS# latency (Tcl)**

This option determines CAS Latency. When synchronous DRAM is installed, the number of clock cycles of CAS latency depends on the DRAM timing. Do not reset this option from the default system manufacturer value. This option is adjustable only when "DRAM Timing Selectable" is set to "Manual". This option is locked when "DRAM Timing Selectable" is set to "By SPD" and is automatically determined by the system.

Options: 2.0, 2.5 (Default), 3.

**Min RAS# active time (Tras)**

This option allows you to select DRAM Active to Precharge Delay.

Options: Auto, 5T, 6T, 7T, 8T (Default), 9T, 10T, 11T, 12T, 13T, 14T, 15T.

**RAS# to CAS# delay (Trcd)**

This option allows to set the RAS# to CAS# delay to Rd/Wr command on the same bank.  
Options: Auto, 2T, 3T (Default), 4T, 5T, 6T, 7T.

**Row precharge Time (Trp)**

You can set the Row precharge time. Precharge to Active or Auto-Refresh of the same bank.  
Options: Auto, 2T, 3T(Default), 4T, 5T, 6T, 7T.

**1T/2T Memory Timing**

Use this option to select the memory timing.  
Options: 1T, 2T(Dault).

**Frame Buffer Size**

This option allows you to set for pure DOS mode of using. You can set the amount of value to share main memory.  
Options: 32M, 64M (Default), 128M, Disable.

**RGB/TV Display**

This option allows you to set for display shade mode of using.  
Options: Auto (Default), RGB, TV.

**TV Mode Support**

This option allows you to set the TV mode regarding your country.  
Options: NTSC-M, NTSC-J, PAL-M, PAL-BDGHl, PAL-NC, Disabled (Default).

**System BIOS Cacheable**

When enabled, accesses to system BIOS ROM addressed at F0000H-FFFFFH are cached, provided that the cache controller is enabled.  
Options: Enabled, Disabled (Default).

**PnP/PCI Configurations**

**PCI / VGA Palette Snoop**

Some graphic controllers that are not VGA compatible take the output from a VGA controller and map it to their display as a way to provide boot information and VGA compatibility.  
Options: Disabled (Default), Enabled.

**PCI Latency Timer (CLK)**

This option allows you to set up the PCI Latency Time (0-255). If you select "32" it will optimize PCI speeds.  
Options: 0-255, 32 (Default).

**\*\*PCI Express relative items\*\***

**Maximum Payload Size**

This item allows you to set the PCI-Express maximum payload size per time.  
Options: 128, 256, 512, 1024, 2048, 4096(Default).

## **Frequency/Voltage Control**

### **CPU Speed Detected**

This option displays the default CPU speed.

### **CPU Host Frequency (MHz)**

This option displays the CPU Host frequency. You can set it from 200 to 450. The default depends on your CPU frequency and the CPU installed.

### **CPU Spread Spectrum**

The Spread Spectrum function can reduce the EMI (Electromagnetic Interference) generated for CPU.

Options: Disabled, Center (Default), Down.

### **DDR Speed (stroke/sec)**

This option displays the current DDR speed (CPU Host frequency \* Max Memclock ÷ 100).

### **Hammer Fid control**

This option displays the CPU ratio information detected by the system.

Options: The options that will be available will depend on the default value of the CPU installed.

For example, if the CPU default value is 10 then the options will be from Start up, and 4 to 12.

Note: Before you try to make any adjustments to this option, make sure that your CPU Ratio is adjustable and has not been locked by the CPU manufacturer.

### **CPU Speed Setting**

This option displays the CPU speed.



CPU Speed = Current CPU Host Frequency x CPU Clock Ratio  
DDR Speed = Current CPU Host Frequency x (Max Memclock ÷ 100)

### **K8 <—> NB HT Ratio**

This option allows you to set Hyper Transport frequency for Northbridge chipset.

Options: 1x, 2x, 3x, 4x, 5x, Auto (Default).

### **K8 <—> NB HT Frequency**

This option displays the result of your HT Ratio setting for Northbridge chipset.

### **NB <—> SB HT Ratio**

This option allows you to set Hyper Transport frequency between Northbridge chipset and Southbridge chipset.

Options: 1x, 2x, 3x, 4x(Default), 5x.

### **NB <—> SB HT Frequency**

This option displays the result of your HT Ratio setting between Northbridge chipset and Southbridge chipset.

**HT Spread Spectrum**

The Spread Spectrum function can reduce the EMI (Electromagnetic Interference) generated for Hyper Transport.

Options: Disabled, Center (Default), Down.

**PCIE Clock**

This option allows you to select PCIE clock form 100 Mhz (Default) to 145Mhz.

**PCIE Spread Spectrum**

The Spread Spectrum function can reduce the EMI (Electromagnetic Interference) generated for PCI-Express.

Options: Enabled (Default), Disabled.

**CPU Voltage (Volt)**

This option allows you to adjust your CPU core voltage.

Options: Default, +5%, +10%, +15%.

**DDR Voltage (Volt)**

This option allows you to adjust the RAM voltage.

Options: 2.7V (Default), 2.8V, 2.9V, 3.0V.

**Chipset Voltage (Volt)**

This option allows you to adjust the North/ South bridge chipsets voltages.

Options: 1.20V (Default), 1.25V, 1.30V, 1.35V.



**Attention**

Before overclocking, please make sure your system components are capable of overclocking. If you are familiar with the overclocking, we strongly recommend you to set the clock to the default settings. We do not guarantee that damage will or will not occur when overclocking.

## Integrated Peripherals

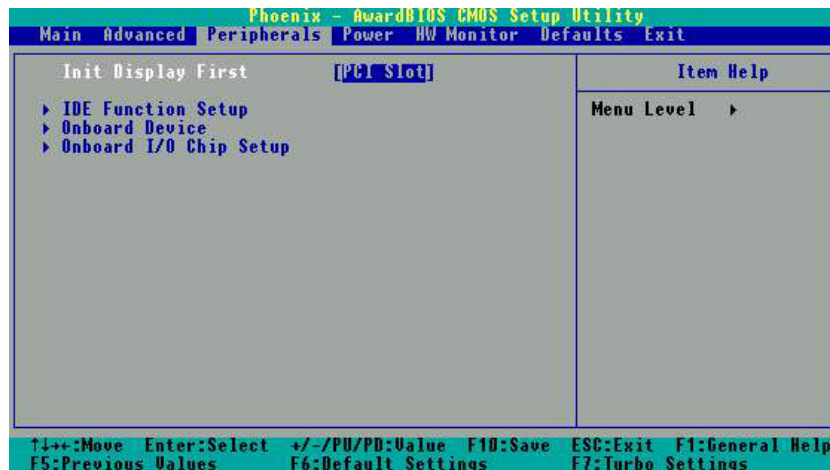

### **Init Display First**

With systems that have multiple video cards, this option determines whether the primary display uses a PCI slot or a PCI-E slot.

Options: PCI Slot, Onboard, PCIEx.

### **IDE Function Setup**

If you highlight the "IDE Function Setup" label and then press the enter key, it will take you to a submenu with the following options:

#### **OnChip IDE Channel 0/1**

The mainboard chipset contains a PCI IDE interface with support for two IDE channels. Select "Enabled" to activate the first and/or second IDE interface. Select "Disabled" to deactivate an interface if you are going to install a primary and/or secondary add-in IDE interface.

Options: Enabled (Default), Disabled.

#### **Primary/Secondary Master/Slave PIO**

The IDE PIO (Programmed Input / Output) fields let you set a PIO mode (0-4) for each of the IDE devices that the onboard IDE interface supports. Modes 0 to 4 will increase performance incrementally. In Auto mode, the system automatically determines the best mode for each device. Options: Auto (Default), Mode0, Mode1, Mode2, Mode3, Mode4.

#### **Primary/Secondary Master/Slave UDMA**

Ultra DMA 100 functionality can be implemented if it is supported by the IDE hard drives in your system. As well, your operating environment requires a DMA driver (Windows 95 OSR2 or a third party IDE bus master driver). If your hard drive and your system software both support Ultra DMA 100, select "Auto" to enable BIOS support. Options: Auto (Default), Disabled.

**IDE Prefetch Mode**

The “onboard” IDE drive interface supports IDE prefetching for faster drive access. If you install a primary and/or secondary add-in IDE interface, set this option to “Disabled” if the interface does not support prefetching.

Options: Enabled (Default), Disabled.

**IDE HDD Block Mode**

Block mode is otherwise known as block transfer, multiple commands, or multiple sectors read/write. Select the “Enabled” option if your IDE hard drive supports block mode (most new drives do). The system will automatically determine the optimal number of blocks to read and write per sector.

Options: Enabled (Default), Disabled.

**RAID Config**

If you highlight the “RAID Config” label and then press the enter key, it will take you to a submenu with the following options:

**SATA1/2 Primary/ Secondary RAID**

This allows you to enable or disable the RAID function for the SATA1/2 Primary/Secondary device.

Options: Enabled, Disabled(Default).

**Serial-ATA 1/2**

This item allows you to enable or disable the SATA1/2 device.

Options: Enabled (Default), Disabled.

**Onboard Device**

If you highlight the “Onboard Device” label and then press the enter key, it will take you to a submenu with the following options:

**OnChip USB**

This option should be enabled if your system has a USB port installed on the system board. You will need to disable this feature if you add a higher performance controller.

Options: V1.1+V2.0 (Default), Disabled, V1.1.

**USB Memory Type**

This option allows you to set your USB Memory Type.

Options: SHADOW, Base Memory (640k) (Default).

**USB Keyboard Support**

This option allows you to enable the USB attached keyboards and storages.

Options: Disabled (Default), Enabled.

**AC97 Audio**

This option allows you to control the onboard AC’97 audio.

Options: Enabled (Default), Disabled.

**MAC Lan**

This option allows you to control the onboard LAN device. Options: Enabled (Default), Disabled.

## **Onboard I/O Chip Setup**

If you highlight the "Onboard I/O Chip Setup" label and then press the enter key, it will take you to a submenu with the following options:

### **Power On Function**

This option allows you to select a method of awakening the system from sleep mode.

Options: Hot KEY, Mouse Left, Mouse Right, Any KEY, BUTTON ONLY (Default), and Keyboard 98.

### **Hot Key Power ON**

This option allows you to use the Ctrl key along with a hot key (function key) to power on your system. This option is configurable only when "Power-On Function" is set to "Hot Key".

Options: Ctrl-F1 (Default), Ctrl-F2..... Ctrl-F12.

### **Onboard FDC Controller**

Select "Enabled" if your system has a floppy disk controller (FDC) installed on the system board and you wish to use it. If you install an add-in FDC or the system has no floppy drive, select "Disabled". Options: Enabled (Default), Disabled.

### **Onboard Serial Port 1**

Select an address and corresponding interrupt for the first/ second serial port.

Options: Disabled (Default for port1), 3F8/IRQ4, 2F8/IRQ3 (Default for port2), 3E8/IRQ4, 2E8/IRQ3, Auto.

### **Onboard Parallel Port**

Select an address and corresponding interrupt for the onboard parallel port.

Options: 378/IRQ7, 278/IRQ5, 3BC/IRQ7, Disabled (Default).

### **Parallel Port Mode**

This option allows you to select a parallel port mode for the onboard parallel port.

Options: ECP(Default) Extended Capabilities Port.  
EPP Enhanced Parallel Port.  
SPP Standard Printer Port.  
ECP+EPP ECP & EPP mode.  
Normal

### **EPP Mode Select**

Select EPP port type 1.7 or 1.9. This field is only configurable if "Parallel Port Mode" is set to "EPP" or "ECP+EPP". Options: EPP 1.9(Default), EPP 1.7.

### **ECP Mode Use DMA**

Select a DMA Channel for the parallel port when using the ECP mode. This option is only configurable if "Parallel Port Mode" is set to "ECP". Options: 3 (Default), 1.

### **PWRON After PWR-Fail**

This option will determine whether your system will boot after restoring power after a power failure. If you select "On", the system will boot whether or not the system was on before power failure. If you select "Former-Sts", the system will be restored to the status before the power failure. Options: Off (Default), On, Former-Sts.

## Power Management

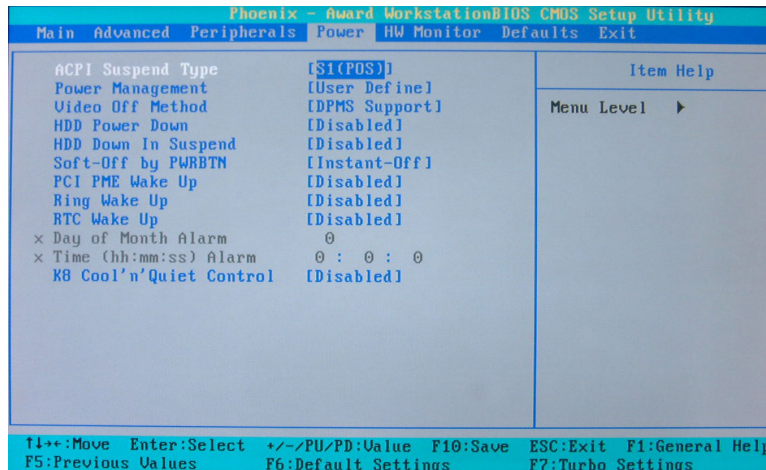

The Power Management Setup Menu allows you to configure your system to utilize energy conservation features as well as power-up/ power-down options.

### ACPI Suspend Type

The item allows you to select the suspend type using the ACPI operating system.

Options: S1 (POS) (Default)      Power on Suspend  
           S3 (STR)                      Suspend to RAM  
           S1 & S3                        POS and STR

### Power Management

There are three options of Power Management:

#### 1. Min. Power Saving

Minimum power management  
 Suspend Mode = 1 hour  
 HDD Power Down = 15 minutes

#### 2. Max. Power Saving

Maximum power management (only available for SI CPUs).  
 Suspend Mode = 1 minute  
 HDD Power Down = 1 minute

#### 3. User Defined (Default)

This option allows you to set each mode individually.

When this option is enabled, each of the ranges is from 1 minute to 1 hour except for HDD Power Down, which ranges from 1 minute to 15 minute and includes a "disable" option.

**Note:** If you select Min. or Max. Power Saving modes, the "HDD Power Down" value will be fixed. User Define, Min Saving, Max Saving

### **Video Off Method**

This option determines the manner in which the monitor goes blank.

Options:

V/H SYNC+Blank This selection will cause the system to turn off the vertical and horizontal synchronization ports and write blanks to the video buffer.

Blank Screen This option only writes blanks to the video buffer.

DPMS Support (Default) Initial display power management signaling.

### **HDD Power Down**

When enabled, the hard disk drive will power down after a certain configurable period of system inactivity. All other devices remain active.

Options: Disabled (Default), 1 Min, 2 Min, 3 Min, 4 Min, 5 Min, 6 Min, 7 Min, 8 Min, 9 Min, 10 Min, 11 Min, 12 Min, 13 Min, 14 Min, 15Min.

### **HDD Down In Suspend**

This option allows you to enable/ disable the hard driver power down in the suspend state.

Options: Disabled (Default), Enabled.

### **Soft-Off by PWRBTN**

In situations where the system enters a “hung” state, you can configure the BIOS so that you are required to press the power button for more than 4 seconds before the system enters the Soft-Off state. Options: Delay 4 Sec, Instant-Off (Default).

### **PCI PME Wake Up**

This option will also cause the system to wake up with any onboard LAN activity.

Options: Disabled (Default), Enabled.

### **Ring Wake Up**

This option allows you to awaken the system upon receiving an incoming call from a modem device. Options: Disabled (Default), Enabled.

### **RTC Wake Up**

When “Enabled”, you can set the date and time at which the RTC (real-time clock) alarm awakens the system from Suspend mode. Options: Enabled, Disabled (Default).

### **Day of Month Alarm**

You can choose which date of the month the system will boot up. This option is configurable only when “RTC Wake Up” is set to “Enabled”. (Min=0 Max=31)

### **Time (hh: mm: ss) Alarm**

You can choose the hour, minute and second the system will boot up. This option is configurable only when “RTC Wake Up” is set to “Enabled”.

### **K8 Cool'n'Quiet Control**

When this option is set to “Auto”, the system will auto control the CPU voltage and frequency depends the loading of system. Options: Auto, Disabled (Default).

## Hardware Monitor

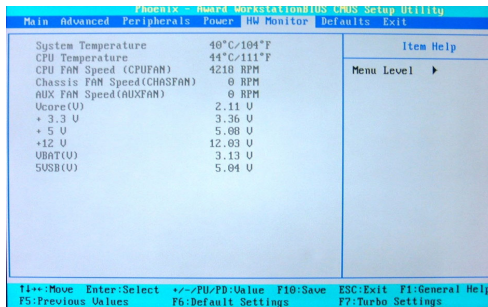

This menu is for monitoring the system status such as temperature, voltage, and so on.

## Load Defaults/Exit Menu

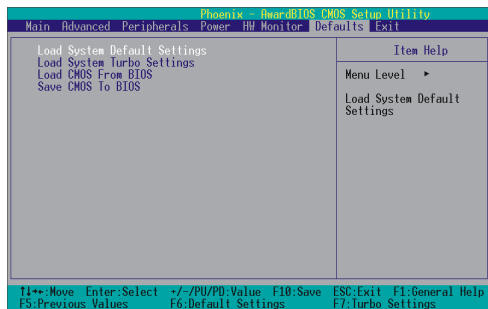

### Load Defaults

#### Load System Default Settings

Load System Default Settings.

#### Load System Turbo Settings

Load System Turbo Settings.

#### Load CMOS From BIOS

Load defaults from flash ROM for systems without batteries.

#### Save CMOS To BIOS

Save defaults to flash ROM for systems without batteries.

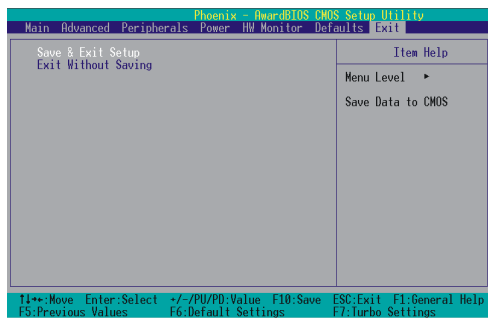

### Exit Menu

#### Save & Exit Setup

Save all configuration changes to CMOS (memory) and exit setup. A confirmation message will be displayed before proceeding.

#### Exit Without Saving

Abandon all changes made during the current session and exit setup. A confirmation message will be displayed before proceeding.

## Chapter 3: Software Setup

### Software List

Category	Platform
Microsoft® DirectX9.0c	Windows 98 /ME /2000 /XP
nForce® Chipset Driver	Windows 2000 /XP
nForce® Display Driver	Windows 2000 /XP
Realtek® Audio Driver	Windows 98 /ME /2000 /XP
Trend PC-Cillin 2005	Windows 98 /ME /2000 /XP
Adobe® Acrobat Reader 5	Windows 98 /ME /2000 /XP
Dr. Speed	Windows 2000 /XP

### Software Installation

Place the Driver CD into the CD-ROM drive and the Installation Utility will auto-run. You can also launch the Driver CD Installation Utility manually by executing the Intel.exe program located on the Driver CD. (For more details, please refer to the Readme.txt files that in each folder of the Driver.)

© The pictures shown below are for your reference only. The version of the software you received and shown on the screen may vary depending on models.

When you insert the driver CD into the CD ROM, you'll see the screen as the picture below. There are several buttons displayed in the main screen as shown below.

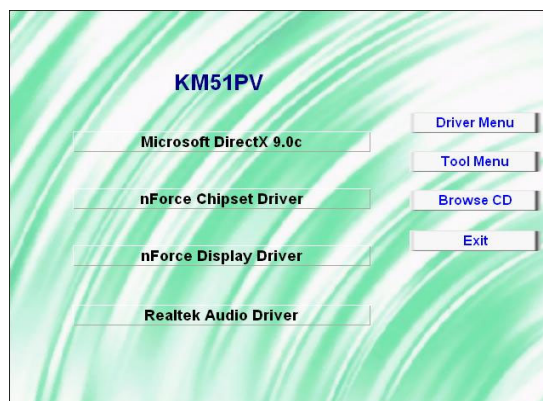

- Microsoft DirectX9.0c – It provides the software of Microsoft DirectX9.0c.
- nForce Chipset Driver – It provides all the drivers needed for the chipset.

## Mainboard KM51PV

- nForce Display Driver – It provides the driver for being able to display.
- Realtek Audio Driver – It provides the driver for being able to input/output audio.



### **Attention**

Please install Microsoft DirectX 9.0c (or the latest version), and then install the nForce Chipset Driver.

2. Click the “Utilities” and you can choose the software to install.



- Trend PC-Cillin 2005 – It provides the software of Trend PC-Cillin 2005 (Anti-virus program).
- Adobe Acrobat Reader5 – Install this software, you can browse files with PDF format.
- Microsoft DirectX9.0c – It provides the software of Microsoft DirectX9.0c.
- Dr. Speed – Install this software, you can enhance the mainboard with higher efficiency of overclocking executed and more stable of voltages supplied.

3. If you click the “Browse CD” button from the screen in step 1, you can browse all the files in the Driver CD.

4. Click “Exit” button to exit the program.

## **Chapter 4: Troubleshooting**

### **Problem 1:**

No power to the system. Power light does not illuminate. Fan inside power supply does not turn on. Indicator lights on keyboard are not lit.

Causes:

1. Power cable is unplugged.
2. Defective power cable.
3. Power supply failure.
4. Faulty wall outlet; circuit breaker or fuse blown.

Solutions:

1. Make sure power cable is securely plugged in.
2. Replace cable.
3. Contact technical support.
4. Use different socket, repair outlet, reset circuit breaker or replace fuse.

### **Problem 2:**

System inoperative. Keyboard lights are on, power indicator lights are lit, hard drive is active but system seems "hung"

Causes: Memory DIMM is partially dislodged from the slot on the mainboard.

Solutions:

1. Power Down
2. Using even pressure on both ends of the DIMM, press down firmly until the module snaps into place.

### **Problem 3:**

System does not boot from the hard disk drive but can be booted from the CD-ROM drive.

Causes:

1. Connector between hard drive and system board unplugged.
2. Damaged hard disk or disk controller.
3. Hard disk directory or FAT is corrupted.

Solutions:

1. Check the cable running from the disk to the disk controller board. Make sure both ends are securely attached. Check the drive type in the standard CMOS setup.
2. Contact technical support.
3. Backing up the hard drive is extremely important. Make sure you periodically perform backups to avoid untimely disk crashes.



## **Mainboard KM51PV**

### **Problem 4:**

System only boots from the CD-ROM. The hard disk can be read and applications can be used but booting from the hard disk is impossible.

Causes: Hard Disk boot sector has been corrupted.

Solutions: Back up data and applications files. Reformat the hard drive. Re-install applications and data using backup disks.

### **Problem 5:**

Error message reading "SECTOR NOT FOUND" displays and the system does not allow certain data to be accessed.

Causes: There are many reasons for this such as virus intrusion or disk failure.

Solutions: Back up any salvageable data. Then performs low level format, partition, and then a high level format the hard drive. Re-install all saved data when completed.

### **Problem 6:**

Screen message says "Invalid Configuration" or "CMOS Failure."

Causes: Incorrect information entered into the BIOS setup program.

Solutions: Review system's equipment. Reconfigure the system.

### **Problem 7:**

The Screen is blank.

Causes: No power to monitor.

Solutions: Check the power connectors to the monitor and to the system.

### **Problem 8:**

Blank screen.

Causes:

1. Memory problem.
2. Computer virus.

Solutions:

1. Reboot computer. Reinstall memory. Make sure that all memory modules are securely installed.
2. Use anti-virus programs to detect and clean viruses.

### **Problem 9:**

Screen goes blank periodically.

Causes: Screen saver is enabled.

Solutions: Disable screen saver.



## **Mainboard KM51PV**

### **Problem 10:**

Keyboard failure.

Causes: Keyboard is disconnected.

Solutions: Reconnect keyboard. Replace keyboard if you continue to experience problems.

### **Problem 11:**

No color on screen.

Causes:

1. Faulty Monitor.
2. CMOS incorrectly set up.

Solutions:

1. If possible, connect monitor to another system. If no color appears, replace monitor.
2. Call technical support.

### **Problem 12:**

The screen displays "C: drive failure."

Causes: Hard drive cable not connected properly.

Solutions: Check hard drive cable.

### **Problem 13:**

Cannot boot the system after installing a second hard drive.

Causes:

1. Master/slave jumpers not set correctly.
2. Hard drives are not compatible / different manufacturers.

Solutions:

1. Set master/slave jumpers correctly.
2. Run SETUP program and select the correct drive types. Call drive manufacturers for possible compatibility problems with other drives.

### **Problem 14:**

Missing operating system on hard drive.

Causes: CMOS setup has been changed.

Solutions: Run setup and select the correct drive type.

### **Problem 15:**

Certain keys do not function.

Causes: Keys jammed or defective.

Solutions: Replace keyboard.



# **Appendix I: Super 5.1 Channel Audio Effect Setup**

## **Channels Setup**

1. After starting your system, click the Sound Effect Manager icon  from the tool bar on the desktop. You can also find the icon by going to Start-> Setting -> Control Panel.
2. Click the Speaker Configuration button. One of the screens will display as shown below.
3. You can choose a 2, 4 or 6 channel (speaker) system.

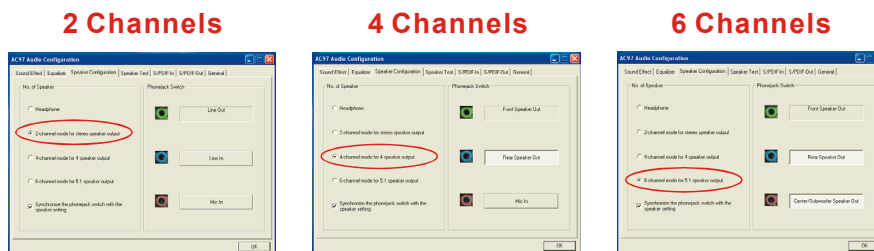

## **Super 5.1 Channel Audio Effect**

This mainboard comes with an ALC655 Codec which supports high quality 5.1 Channel audio effects. With ALC655, you are able to use standard line-jacks for surround audio output without connecting to any auxiliary external modules. To use this function, you have to install the audio driver in the bonus Pack CD as well as an audio application supporting 5.1 Channel audio effects. See the audio Port Connectors in the Hardware Installation section for a description of the output connectors.

## **Speaker Test**

Make sure the cable is firmly into the connector.

1. Click the audio icon  from the Windows screen.
2. Click Speaker Test button, you can see the screen like the pictures below.
3. Select the speaker which you want to test by clicking on it.



## **Appendix II: RAID Setup**

### **Introduction to RAID**

RAID (Redundant Array of Independent Disks) technology is a sophisticated disk management system that manages multiple disk drives. It enhances I/O performance and provides redundancy in order to prevent the loss of data in case of individual disk failure. The RAID facility on this board provides RAID 0, RAID 1, RAID 0+1, RAID JBOD, and RAID 5.

#### **Disk Striping (RAID 0)**

Striping is a performance-oriented, non-redundant disk storage technology. With RAID striping, multiple disks are used to form a larger virtual disk. Data is then striped or mapped across all the physical disks. In this way, multiple I/O operations can be executed in parallel, enhancing performance. Striping does not provide fault tolerance. The minimum number of hard drives for RAID 0 is 2.

#### **Disk Mirroring (RAID 1)**

With Disk Mirroring there are redundant disks that mirror the primary disks. Data that is written to the primary disks are also written to the redundant disks. This redundancy provides fault tolerant protection from a single disk failure. If a read/write failure occurs on one drive, the system can still read and write data using the other drive. The minimum number of drives for a RAID 1 configuration is 2. You are required to use an even number of drives.

#### **Disk Striped Mirroring (RAID 0+1)**

This mode combines both the performance benefits of RAID 0 with the fault tolerance of RAID 1. The minimum number of drives for RAID 0+1 configuration is 4 drives. This configuration also requires an even number of drives. **Note:** All mirrored configurations or striped/mirrored configurations should use drives of the same size.

#### **RAID SPAN (RAID JBOD)**

RAID SPAN allows JBOD (Just a Bunch Of Disks) configurations which simply uses multiple disks to form a larger virtual disk without any other specialized disk management functionality. RAID SPAN is not considered a standard RAID implementation.

#### **Disk Rotating Parity Array (RAID 5)**

RAID 5 is one of the most popular implementations of RAID. It utilizes the configurations of Byte Striping and Block Striping, and writes the data to multiple disks. The minimum number of drives for a RAID 5 configuration is 3. It possesses the stripe error correction information; therefore, once a read/write failure occurs on one drive, the system can still read and write data using the other drive. As result, the performance of RAID 5 can substantially decrease in a write-heavy environment.

### **Before create RAID Array**

Before you configure your RAID Array, you have to enable the "RAID Config" option in the BIOS Setup Utility.

1. After you boot your system, press the "Del" key when prompted to enter the BIOS Setup Utility.
2. The "RAID config" option for enabling RAID will be found on the "Peripherals" screen as part of the "IDE Function Setup" section shown as below-left (Peripherals >> IDE Function Setup >> RAID config). Arrow down to the IDE RAID item and press enter.

## Mainboard KM51PV

3. On the “RAID config” screen (shown below-right), enable the disks that you want to use as RAID disks (in this example there are four SATA hard drives configured as RAID disks).

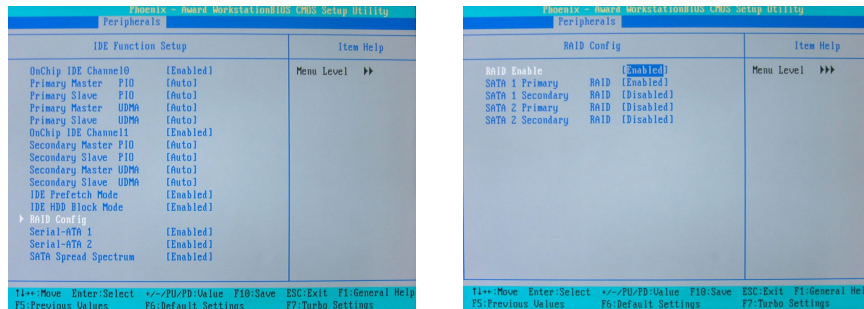

## NVIDIA RAID Utility Configuration

The NVIDIA RAID Utility is used to configure RAID disk management into your hard disks. This section will explain how to setup and maintain your RAID disk drives.

Starting up the NVIDIA BIOS RAID Utility

When the system boots up during the POST (Power-On Self Test), you will be given an opportunity to enter the NVIDIA BIOS RAID Utility when the screen prompts you with following message:

“Press F10 to enter RAID setup utility”

Press the <F10> key to enter the NVIDIA BIOS RAID utility (note that you will only have a short window of time to press <F10> before the system continues with the next step of the boot process). The Raid Utility screen will display as shown right.

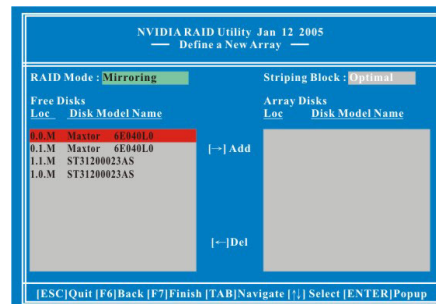

### Associating Screen Drive Names

#### with Physical Drives on the Board

This section explains how to associate the drives listed on the “Define a New Array” screen with the physical drives attached to the connectors on the mainboard. This becomes important when identifying drives that need to be replaced or changed.

#### Channel, Controller, Master/Slave

Located here are 3 identifiers separated by periods. These identifiers represent the Channel, Controller, and Master/Slave ID for a drive. With these identifiers, you can associate the drives on this screen with a physical connector and drive on the board.

Channel 0 – Represents one of the SATA connectors

Channel 1 – Represents one of the SATA connectors

Controller 0 – 1st connector (e.g. SATA1 or SATA1)

Controller 1 – 2nd connector (e.g. SATA2 or SATA2)

Master/Slave – SATA drives will always be Master drives since a SATA connector can only support 1 drive. SATA connectors can support a Master and a Slave drive.

## Mainboard KM51PV

Examples:

On a board with 4 connectors (PATA1, PATA2, SATA1, SATA2), the following applies:

0.0.M = PATA1 (master drive)

0.0.S = PATA1 (slave drive)

0.1.M = PATA2 (master drive)

0.1.S = PATA2 (slave drive)

1.0.M = SATA1

1.1.M = SATA2

### Creating New RAID Array

The first screen you will see upon initial configuration is the “Define New Array” screen. First, tab over to the “RAIDMode” text box and press <Enter>. The pop up menu will display as shown below. According to your configuration requirements, select “Mirroring” (RAID 1), “Striping” (RAID 0), “Striping Mirroring” (RAID 0+1), “Spanning” (JBOD), or “RAID5”. Then press <Enter>.

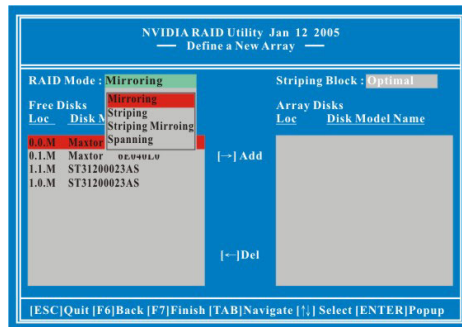

#### Attention

The “Loc” and “Disk Model Name”, located on this screen reflect the disk drives installed on the PATA or SATA connectors. The example disk drive information may differ with the information that displays on your screen.

Next, <Tab> over to the “Striping Block” option and press <Enter>. A pop menu will display as shown below. With this option you can manually select the striping block size for your array. This option will affect data access performance. We recommend that you to select “Optimal” option for automatic configuration. Press <Enter>.

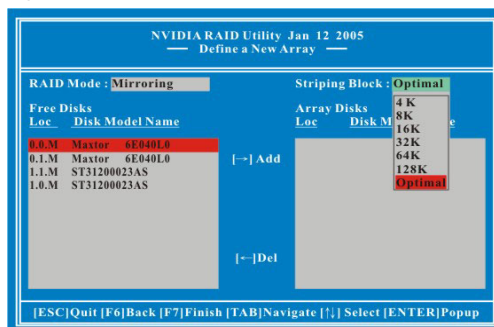

## Mainboard KM51PV

Next, in the “Free Disks” section, you can use the up/down arrow keys to select disks to be used in your RAID array. After highlighting a disk, use the right-arrow key to activate the disk as part of the RAID Array. The selected disk will move over to the “Array Disks” section. You can use the left-arrow key to reverse your selection. After you finish selecting all your disks, Press <F7>. A confirmation message will display as shown below. Then press <Y> to complete the RAID array creation.

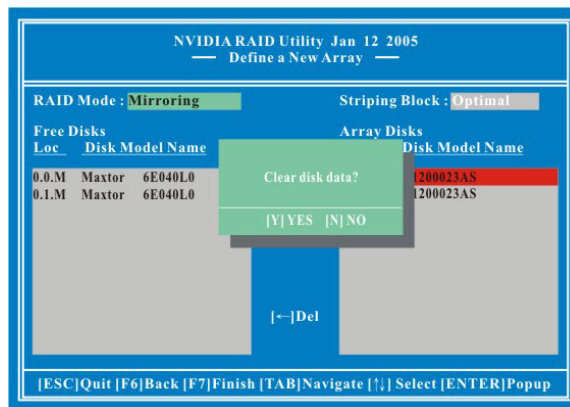

After the array has been successfully created, the Array List screen will display as shown below-left. You can press the Enter key to view the RAID details in the “Array Detail” screen.

### RAID 1 mode (Array List)

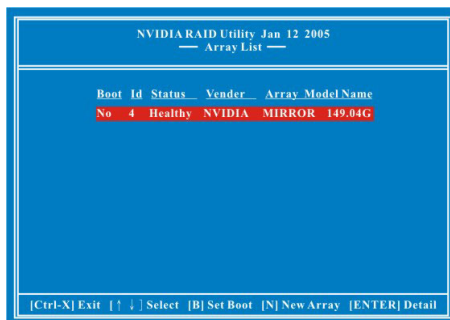

### RAID 1 mode (Array Detail)

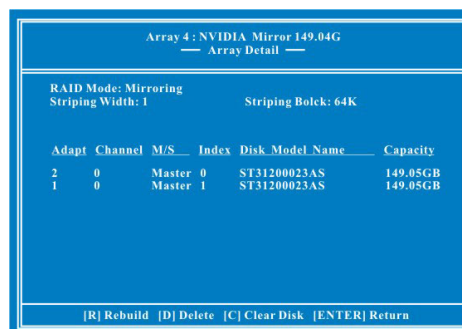

**Deleting an Array**

You can delete an existing array on the “Array Detail” screen. Press the <D> key. A warning/confirmation message will display (as shown below). Press <Y> to confirm.

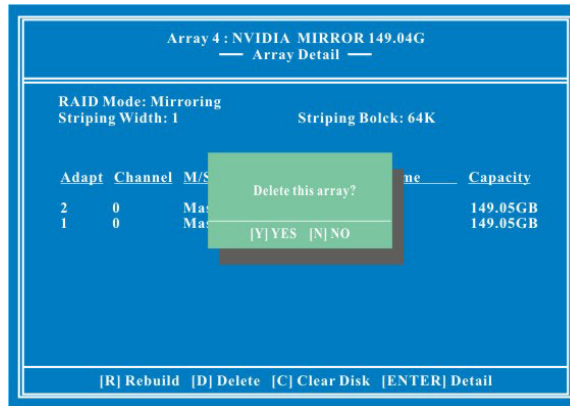

After the array is successfully deleted, the screen will display as shown below.

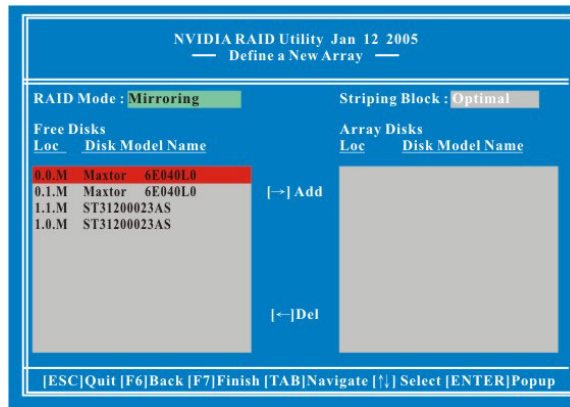

**Rebuilding a RAID Mirrored Array**

This section applies to Mirrored, Striped Mirroring RAID and RAID 5 configurations and describes how to reestablish the integrity of a mirrored environment after replacing one of the drives (typically because of a single disk failure). After replacing the errant drive, the rebuild process will move data from its mirrored sibling drive (the drive with information still intact) to the newly installed drive. This only applies to mirrored configurations (RAID 1, RAID 0+1, RAID 5).

**Before you rebuild a RAID Mirrored Array**

Before you begin rebuilding a RAID Mirrored Array, you must copy the “NvRaidMan.exe” file from the bundled CD Driver to your C: drive. [CD File Location Path => D: \ Driver \ nForce \ 4.24 \ IDE \ WIN2K (or WINXP)\ NvRaidMan.exe]

To rebuild a mirrored array, bring up the NVIDIA RAID Utility. From the “Array List” screen, select the array with the newly installed drive. Then go to the “Array Detail” screen (press Enter). Then press the <R> key and use the up/down arrow keys to select the hard drive that you just installed. Then press <F7>. A confirmation message will display (as shown below). Press <Y> to confirm. Then press <Ctrl-X> to exit the “NVIDIA RAID Utility” setup.

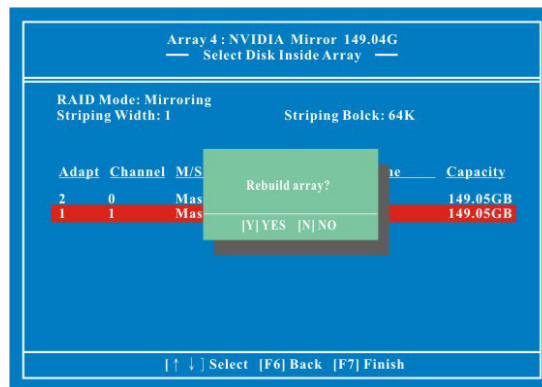

Launch the NVRAID Management utility by double-clicking the NvRaidMan.exe that has been copied to the C: drive. You can view the status of rebuilding under the Details section from the screen as shown below.

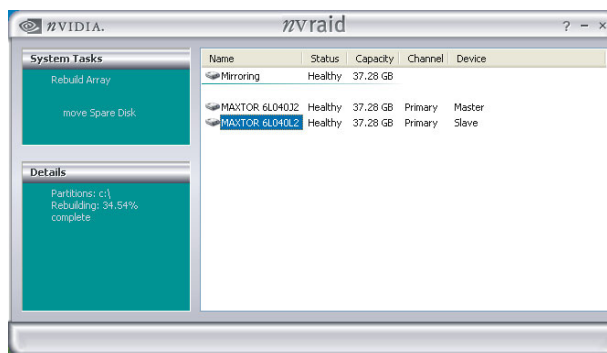

**Install the OS of Windows® 2000/XP into your RAID HDDs**

In this section, it will tell you how to install the operating system of Windows® 2000/XP into your RAID drives. The installation steps below will assume that your HDDs have already been attached to either the PATA or SATA connectors, and also your BIOS RAID Utility has already been configured (see NVIDIA BIOS RAID Utility Configuration section).

**Preparation:** Before starting to install the OS, copy the “RAID Driver” and associated files from the bundle CD Driver to an empty floppy disk [The files location in CD-ROM => \ Driver \ nForce \ 6.53 \ IDE \ Floppy \ \*.\*]. This will have to be done on another system if you are installing the system from scratch.

1. During Windows installation, the “Windows Setup” screen will prompt you with “Press F6 if you need to install third party SCSI or RAID driver”. Press <F6>.
2. Press 's' when setup asks if you want to specify an additional device. Insert the floppy disk which includes the “RAID Driver” into the floppy drive. Press 'Enter' and select the appropriate OS device driver.
3. Press 'Enter' again to continue the setup process.
4. Follow the setup instructions and select your choice for partition and file system.
5. After setup examines your disks, it will copy files to the Windows® 2000/ XP installation folders and restart the system. After the system is rebooted the setup program will continue with the installation all the way to completion.
6. Wait until Windows® 2000/ XP finishes installing devices, regional settings, networking settings, components, and the final set of tasks. Reboot the system if you are asked to do so.



**Attention**

The RAID array can only work with the OS of Windows® 2000/ XP.

## Appendix III: ABS (Albatron BIOS Security) Card Setup

### Introduction

The ABS (Albatron BIOS Security) system provides your system with a recovery BIOS backup when your onboard BIOS has been damaged beyond system boot capability.

### Preparation and Setup

You should prepare a boot floppy disk and have it ready in case of such BIOS failures. Otherwise you will have to find another computer to make the boot floppy disk from. When you make the disk, you should visit our website and download the latest version of the BIOS file for your mainboard along with the AWDFLASH.exe executable, placing both onto the floppy disk.

### Onboard BIOS Recovery Procedures

1. Make sure your system is turned off.
2. Set the jumper cap on the ABS\_JP1 header located on the ABS Card to the "Rescue BIOS" position (figure 1).
3. Remove the jumper caps (on pins 1-2, pins 3-4) from the mainboard BIOSCN2 header (figure 2).
4. Insert the ABS Card onto the BIOSCN2 header on the mainboard. The ABS will fit over the entire BIOSCN2 header and can only be inserted in one direction.

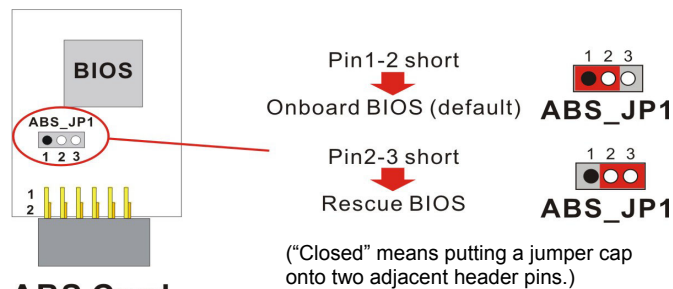
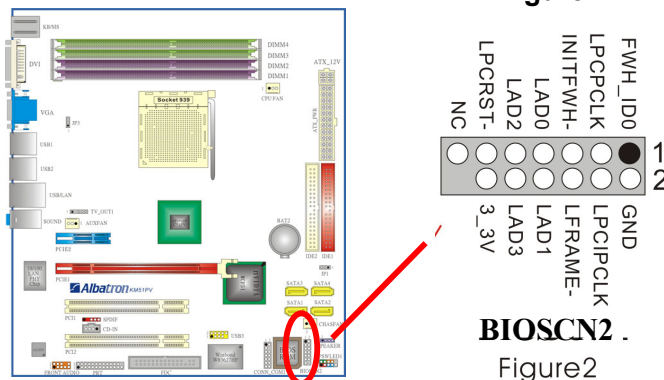

Figure 1



## Mainboard KM51PV

- Place the boot floppy disk (from the “Preparation and Setup” section) into the floppy drive and turn on your system.

**Note:** If your system is not setup to use the floppy drive as the first boot drive, you must enter the BIOS setup utility and make the appropriate adjustments. During the initial boot up sequence the screen will display a message that will give you an opportunity to enter the BIOS setup utility (typically, “Press Delete Key to enter BIOS utility”).

Once in the BIOS Utility, follow this path: Advanced -> Hard Disk Boot Priority -> First Boot Device and set the “First Boot Device” to “Removable”.

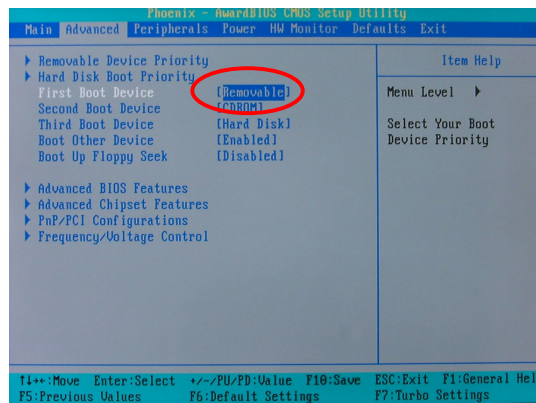

After the system boots from the floppy, the system will enter into the DOS mode (note that the system has booted using the ABS card's BIOS).

- With the system still running, you must carefully move the jumper cap on the ABS Card (ABS\_JP1 header) back to its “Onboard BIOS” position.

This disables the ABS BIOS which will now allow you to flash the corrupted mainboard BIOS from the floppy disk.

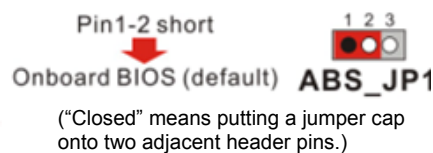

- At the DOS prompt, type “DIR” and take notice of the name of the BIOS file name which ends with the extension “.bin” (e.g. K8N7003.bin). There should also be an AWDFLASH.exe file present. Then type: **awdflash(space)(the file name of .bin).bin** (For example: awdflash(space)k8n7003.bin)

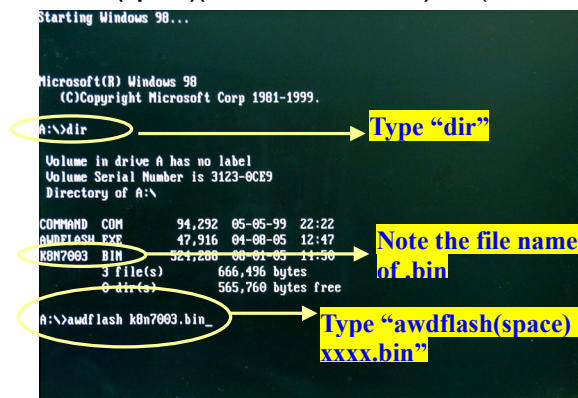

8. The initial AWARD BIOS FLASH screen (shown below-left) will appear and prompt you with the message, “Do you want to save BIOS?” Type “N” (**Note:** Typing “Y” is only used when saving the BIOS from the onboard BIOS to the floppy disk).

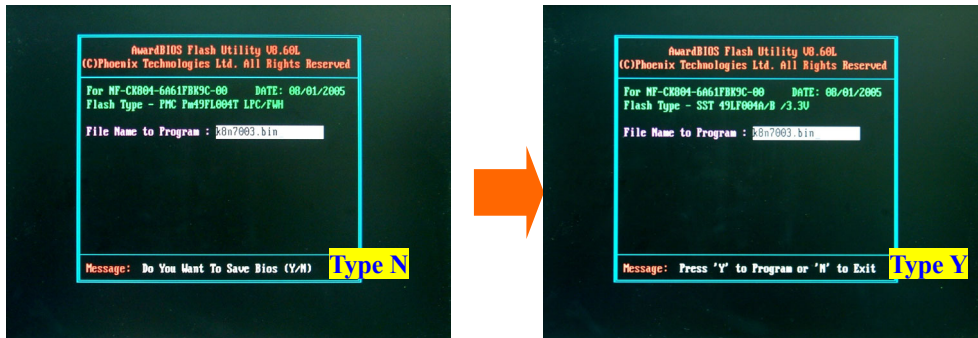

The next screen (shown above-right) will display a message “Press 'Y' to Program or 'N' to Exit”. Then type 'Y' to begin the onboard BIOS flash procedure.

9. The flashing procedure will take several minutes and will show its progress on the screen. After the flash BIOS procedures have completed, press 'F1' to reboot the system.

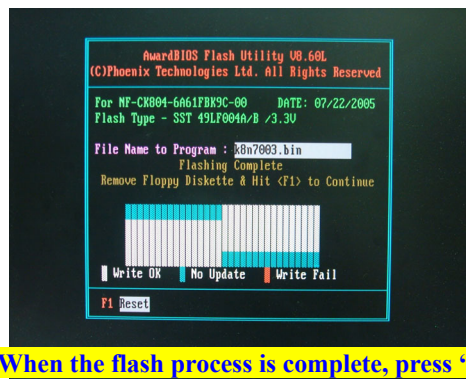

**Attention**

While processing the flash BIOS procedures, DO NOT power off or restart your system. Otherwise, it may damage the onboard BIOS.

## Mainboard KM51PV

10. During the next boot sequence, enter the BIOS utility program (**Note:** During the boot sequence you will be given a chance to enter the BIOS utility by pressing the “DEL” key on most systems). Load the system with the default settings, and save the changes before exit the BIOS utility program. Then the onboard BIOS recovery procedures are completed at this time.

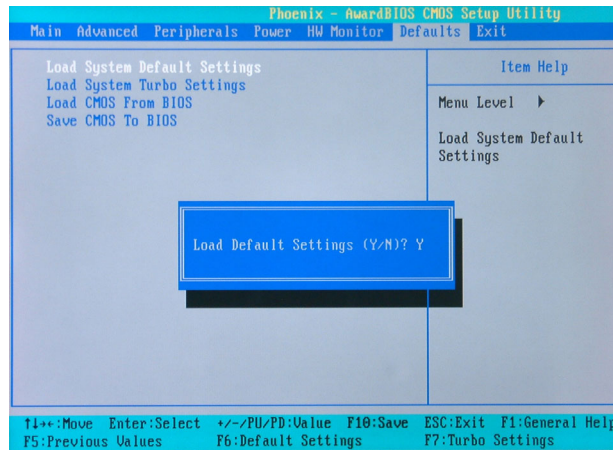

Follow the path: **Defaults -> Load System Default Settings -> Y** .

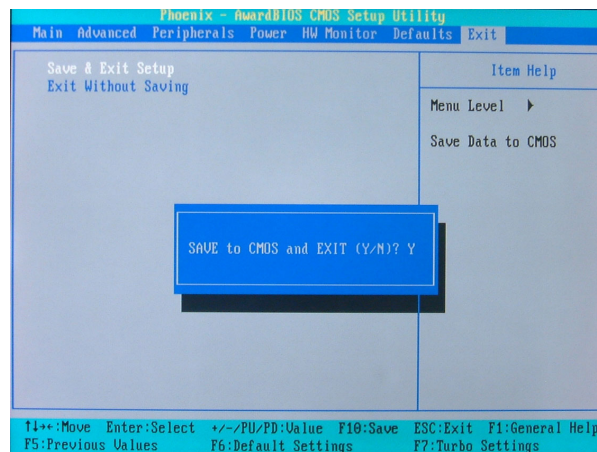

Follow the path: **Exit -> Save & Exit Setup -> Y** .

## Mainboard KM51PV

11. After you have recovered your onboard BIOS, you can choose to remove or not remove the ABS Card from the mainboard.

If you do choose to remove the ABS Card from the mainboard, make sure that the system is powered off before you remove the card. After you remove the ABS card you must replace the two jumper caps on the BIOSCN2 header back to the default positions (pins 1-2 and pins 3-4 are both closed as shown).

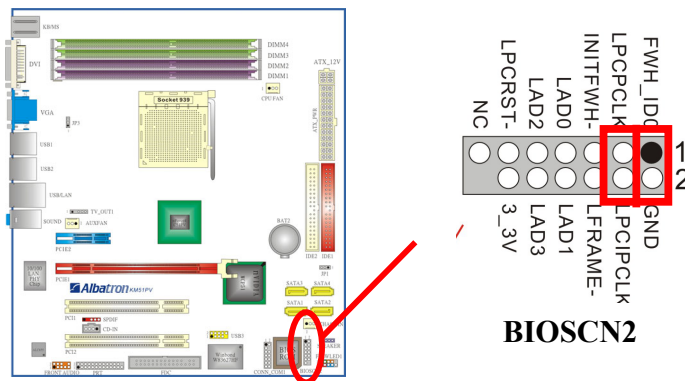

If you choose not to remove the ABS Card from the mainboard, make sure that the jumper caps on the ABS\_JP1 header located on the ABS Card to the “Onboard BIOS” as below, in order to reduce the damage opportunity of the rescue BIOS in ABS Card and on the other hand to extend the usage life of the ABS Card.

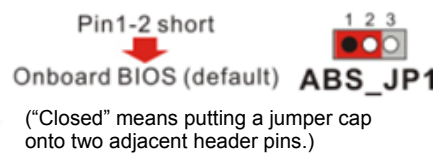

### **Attention**

If both your onboard BIOS and rescue BIOS are damaged unfortunately, the ABS Card will fail the feature of providing BIOS backup. Therefore, it is recommended that recover the onboard BIOS in advance, and take the ABS Card as emergency happen.