



DIGITAL CAMERA

FinePix S5000



Getting Ready

Using the Camera

Advanced Features

Settings

Software Installation

Viewing Images

OWNER'S MANUAL

This manual will show you how to use your FUJIFILM DIGITAL CAMERA FinePix S5000 correctly. Please follow the instructions carefully.



BL00260-200(1)



Warning

To prevent fire or shock hazard, do not expose the unit to rain or moisture.

For customers in the U.S.A.

**Tested To Comply
With FCC Standards
FOR HOME OR OFFICE USE**

FCC Statement

This device complies with part 15 of the FCC Rules. Operation is subject to the following two conditions : (1) This device may not cause harmful interference, and (2) this device must accept any interference received, including interference that may cause undesired operation.

CAUTION

This equipment has been tested and found to comply with the limits for a Class B digital device, pursuant to Part 15 of the FCC Rules. These limits are designed to provide reasonable protection against harmful interference in a residential installation. This equipment generates, uses, and can radiate radio frequency energy and, if not installed and used in accordance with the instructions, may cause harmful interference to radio communications. However, there is no guarantee that interference will not occur in a particular installation. If this equipment does cause harmful interference to radio or television reception, which can be determined by turning the equipment off and on, the user is encouraged to try

to correct the interference by one or more of the following measures :

- Reorient or relocate the receiving antenna.
- Increase the separation between the equipment and receiver.
- Connect the equipment into an outlet on a circuit different from that to which the receiver is connected.
- Consult the dealer or an experienced radio/TV technician for help.

You are cautioned that any changes or modifications not expressly approved in this manual could void the user's authority to operate the equipment.

Notes on the Grant :

To comply with Part 15 of the FCC rules, this product must be used with a Fujifilm-specified ferrite-core A/V cable, USB cable and DC supply cord.

For customers in Canada

CAUTION

This Class B digital apparatus complies with Canadian ICES-003.

Please read the Safety Notes (⇒P.108) and make sure you understand them before using the camera.

IMPORTANT

NOTICE

BEFORE OPENING THE PACKAGE OF CD-ROM PROVIDED BY FUJI PHOTO FILM CO., LTD., PLEASE READ THIS END USER LICENSE AGREEMENT CAREFULLY. ONLY IF YOU DO AGREE TO THIS AGREEMENT, YOU WILL BE ABLE TO USE THE SOFTWARE RECORDED ON THE CD-ROM. BY OPENING THE PACKAGE, YOU ACCEPT AND AGREE TO BE BOUND BY THIS AGREEMENT.

End User License Agreement

This End User License Agreement ("Agreement") is an agreement between Fuji Photo Film Co., Ltd. ("FUJIFILM") and you, which sets forth the terms and conditions of the license granted for you to use the software provided by FUJIFILM.

The CD-ROM contains third party software. In case a separate agreement is provided by a third party supplier for its software, the provisions of such separate agreement shall apply to the use of such third party software, prevailing over those of this Agreement.

1. Definitions.

- "Media" means the CD-ROM titled "Software for FinePix SX" which is provided to you together with this Agreement.
- "Software" means the software which is recorded on Media.
- "Documentation" means the operation manuals of Software and other related written materials which are provided to you together with Media.
- "Product" means Media (including Software) and Documentation collectively.

2. Use of Software.

- FUJIFILM grants to you a nontransferable, nonexclusive license :
- to install one copy of Software onto one computer in binary machine executable form ;
 - to use Software on the computer onto which Software is installed ; and
 - to make one backup copy of Software.

3. Restrictions.

- You shall not distribute, rent, lease or otherwise transfer all or any part of Software, Media or Documentation to any third party without FUJIFILM's prior written consent. You also shall not sublicense, assign or otherwise transfer all or any part of the rights granted to you by FUJIFILM under this Agreement without FUJIFILM's prior written consent.
- Except as expressly granted by FUJIFILM hereunder, you shall not copy or reproduce all or any part of Software or Documentation.
- You shall not modify, adapt or translate Software or Documentation. You also shall not alter or remove copyright and other proprietary notices that appear on or in Software or Documentation.
- You shall not, or shall not have any third party, reverse-engineer, decompile, or disassemble Software.

EC Declaration of Conformity

We

Name : Fuji Photo Film (Europe) G.m.b.H.
Address : Heesenstrasse 31
40549 Dusseldorf, Germany

declare that the product

Product Name : FUJIFILM DIGITAL CAMERA FinePix S5000
Manufacturer's Name : Fuji Photo Film Co., Ltd.
Manufacturer's Address : 26-30, Nishiazabu 2-chome, Minato-ku,
Tokyo 106-8620, Japan

is in conformity with the following Standards

Safety : EN60065
EMC : EN55022 : 1998 Classe B
EN55024 : 1998
EN61000-3-2 : 1995 + A1:1998 + A2:1998

following the provision of the EMC Directive (89/336/EEC, 92/31/EEC and 93/68/EEC) and Low Voltage Directive (73/23/EEC).



Dusseldorf, Germany

July 1, 2003

Place

Date

Signature/Managing Director



Bij dit produkt zijn batterijen geleverd. Wanneer deze leeg zijn, moet u ze niet weggooien maar inleveren als KCA

Be sure to read this page before using the Software.

4. Ownership.

All copyrights and other proprietary rights to Software and Documentation are owned and retained by FUJIFILM or the third party suppliers as indicated on or in Software or Documentation. Nothing contained herein shall be construed, expressly or implicitly, as transferring or granting any right, license, or title to you other than those explicitly granted under this Agreement.

5. Limited Warranty.

FUJIFILM warrants to you that Media is free from any defect in material and workmanship under normal use for ninety (90) days from the date of your receipt of Media. Should Media not meet the foregoing warranty, FUJIFILM shall replace such defective Media with other Media bearing no defect. FUJIFILM's entire liability and your sole and exclusive remedy with regard to any defect in Media shall be expressly limited to such FUJIFILM's replacement of Media as provided herein

6. DISCLAIMER OF WARRANTY.

EXCEPT AS PROVIDED IN SECTION 5 HEREIN, FUJIFILM PROVIDES PRODUCT "AS IS" AND WITHOUT WARRANTIES OF ANY KIND, EXPRESS OR IMPLIED. FUJIFILM SHALL MAKE NO WARRANTY, EXPRESS, IMPLIED OR STATUTORY, AS TO ANY OTHER MATTERS, INCLUDING, BUT NOT LIMITED TO NON-INFRINGEMENT OF ANY COPYRIGHT, PATENT, TRADE SECRET, OR ANY OTHER PROPRIETARY RIGHTS OF ANY THIRD PARTY, MERCHANTABILITY, OR FITNESS FOR ANY PARTICULAR PURPOSE.

7. LIMITATION OF LIABILITY.

IN NO EVENT SHALL FUJIFILM HAVE ANY LIABILITY FOR ANY GENERAL, SPECIAL, DIRECT, INDIRECT, CONSEQUENTIAL, INCIDENTAL, OR OTHER DAMAGES (INCLUDING DAMAGES FOR LOSS OF PROFITS OR LOST SAVINGS) INCURRED FROM THE USE OF OR INABILITY TO USE PRODUCT EVEN IF FUJIFILM HAS BEEN ADVISED OF THE POSSIBILITY OF SUCH DAMAGES.

8. No export.

You acknowledge that neither Software nor any part thereof, will be transferred, or exported to any country or used in any manner in violation of any export control laws and regulations to which Software is subject.

9. Termination.

In case you breach any of the terms and conditions hereof, FUJIFILM may immediately terminate this Agreement without any notice.

10. Term.

This Agreement is effective until the date when you cease to use Software, unless earlier terminated in accordance with Section 9 hereof.

11. Obligation upon termination.

Upon termination or expiration of this Agreement, you shall, at your own responsibility and expense, delete or destroy immediately all Software (including its copies), Media and Documentation.

12. Governing Law.

This Agreement shall be governed by and construed in accordance with laws of Japan.

Contents

Warning	2	Nomenclature	8
IMPORTANT	2	Example of Monitor Text Display	9
EC Declaration of Conformity	3	■ Still photography mode	9
Preface	6	■ Playback mode	9
Accessories included	7		

1 Getting Ready

ATTACH THE LENS CAP/STRAP/ADAPTER RING	10
LOADING THE BATTERIES	11
LOADING THE MEDIA	12
SWITCHING ON AND OFF/SETTING THE DATE AND TIME	14
CORRECTING THE DATE AND TIME/CHANGING THE DATE ORDER	15
Changing the date and time	15
To change the date order	15
SELECTING THE LANGUAGE	16

2 Using the Camera

BASIC OPERATION GUIDE	17
STILL PHOTOGRAPHY MODE	
TAKING PICTURES (AUTO MODE)	20
■ Indicator lamp display	23
NUMBER OF AVAILABLE FRAMES	23
■ Standard number of frames per xD-Picture Card	23
USING AF/AE LOCK	24
AF-ASSIST ILLUMINATOR	25
USING THE ZOOM (OPTICAL ZOOM/DIGITAL ZOOM)	25
BEST FRAMING	26
PLAYBACK MODE	
VIEWING YOUR IMAGES (PLAYBACK)	27
Single-frame playback/Fast-forwarding through your images/Multi-frame playback	27
Single-frame playback/Playback zoom/Panning/Trimming	28
ERASING IMAGES (ERASE FRAME)	29

3 Advanced Features

STILL IMAGE	
F PHOTO MODE STILL IMAGE	
QUALITY MODE (NUMBER OF RECORDED PIXELS)	30
Quality settings in Still photography mode	31
SENSITIVITY	32
High-sensitivity photography (800)	32
FinePix COLOR	33
STILL PHOTOGRAPHY FUNCTIONS	
FOCUSING (DISTANCE)	34
EXPOSURE (SHUTTER SPEED AND APERTURE)	35
TAKING PICTURES – SELECTING THE CAMERA SETTINGS	36
■ List of functions available in each mode	37
■ List of menu options available in each mode	37
AUTO AUTO	38
SP SCENE POSITION	38
Portrait/Landscape/Sports/C Night scene	38
P PROGRAMMED AUTO	39
Program shift	39
S SHUTTER-PRIORITY AUTO	40
A APERTURE-PRIORITY AUTO	41
M MANUAL	42
MACRO (CLOSE-UP) PHOTOGRAPHY	43
FLASH	44
Auto flash mode	45
Red-eye reduction	45
Forced flash	45
Slow synchro	46
Red-eye reduction + Slow synchro	46
Increasing the monitor brightness	46
CONTINUOUS SHOOTING	47
Top 5-frame continuous shooting	48
Auto bracketing	48
Final 5-frame continuous shooting	48
Long-period continuous shooting with 1280 × 960-pixel mode	49
EXPOSURE COMPENSATION	50
CONTINUOUS AF	51
SETTING THE MANUAL FOCUS	52

STILL IMAGE MENU	
PHOTOGRAPHY MENU	53
PHOTOGRAPHY MENU OPERATION	53
SELF-TIMER PHOTOGRAPHY	54
JAF MODE	55
SETTING THE WHITE BALANCE	56
PHOTOMETRY	56
BRACKETING	57
SHARPNESS	57
FLASH BRIGHTNESS ADJUSTMENT	57
MOVIE	
MOVIE MODE	
SHOOTING MOVIES	58
PLAYBACK MODE	
PLAYING BACK MOVIES	60
Playing back movies	60
PLAYBACK	
PLAYBACK MENU	
ERASING SINGLE/ALL FRAMES	61
ALL FRAMES/FRAME/BACK	61
PROTECTING IMAGES : FRAME/SET ALL/RESET ALL	63
FRAME SET	63
FRAME RESET	64
SET ALL	64
RESET ALL	64
AUTO PLAY (AUTOMATIC PLAYBACK)	65
RECORDING VOICE MEMOS	66
PLAYING BACK VOICE MEMOS	68
Playing back voice memos	68
PHOTO MODE PLAYBACK	
HOW TO SPECIFY PRINT OPTIONS (DPOF)	69
DPOF ALL RESET	71
4 Settings	
* ADJUSTING THE MONITOR BRIGHTNESS/ADJUSTING THE VOLUME	72
SET-UP	73
■ SET-UP menu options	73
USING THE SET-UP SCREEN	73
IMAGE DISPLAY	74
Preview zoom	74
Continuous shooting preview (image checking)	74
POWER SAVE SETTING (low power setting)	75
FORMAT	75
FRAME NO.	76
CCD-RAW	76

5 Software Installation

5.1 THE SOFTWARE COMPONENTS	77
5.2 INSTALLATION ON A Windows PC	78
5.3 INSTALLATION ON A Mac OS 8.6 TO 9.2	80
5.4 INSTALLATION ON A Mac OS X	83

6 Viewing Images

6.1 CAMERA CONNECTION	86
6.1.1 Using the optional AC Power Adapter (sold separately)	86
6.1.2 Connecting to a TV	86
6.1.3 Connecting to a computer	87
6.1.4 Disconnecting the camera	91
6.2 USING FinePixViewer	92
6.2.1 Mastering FinePixViewer	92
6.2.2 Uninstalling the software	92

System Expansion Options	94	AC Power Adapter	98
Accessories Guide	95	Procedure for discharging rechargeable Ni-MH batteries	99
Conversion Lens Guide (sold separately)	96	Notes on the xD-Picture Card™	100
Notes on Using Your Camera Correctly	97	Warning Displays	101
Notes on the Power Supply	97	Troubleshooting	103
Applicable Batteries	97	Specifications	105
Notes on the Batteries	97	Explanation of Terms	107
Notes on using the AA-size Ni-MH batteries correctly	98	Safety Notes	108

Preface

■ Test Shots Prior to Photography

For particularly important photographs (such as weddings and overseas trips), always take a test photograph and view the image to make sure that the camera is functioning normally.

● Fuji Photo Film Co., Ltd. cannot accept liability for any incidental losses (such as the costs of photography or the loss of income from photography) incurred as a result of faults with this product.

■ Notes on Copyright

Images recorded using your digital camera system cannot be used in ways that infringe copyright laws without the consent of the owner, unless intended only for personal use. Note that some restrictions apply to the photographing of stage performances, entertainments and exhibits, even when intended purely for personal use. Users are also asked to note that the transfer of **xD-Picture Card** containing images or data protected under copyright laws is only permissible within the restrictions imposed by those copyright laws.

■ Liquid Crystal

If the LCD monitor is damaged, take particular care with the liquid crystal in the monitor. If any of the following situations arise, take the urgent action indicated.

- If liquid crystal comes in contact with your skin
Wipe the area with a cloth and then wash thoroughly with soap and running water.
- If liquid crystal gets into your eye
Flush the affected eye with clean water for at least 15 minutes and then seek medical assistance.
- If liquid crystal is swallowed
Flush your mouth thoroughly with water. Drink large quantities of water and induce vomiting. Then seek medical assistance.

■ Notes on Electrical Interference

If the camera is to be used in hospitals or aircrafts, please note that this camera may cause interference to other equipment in the hospital or aircraft. For details, please check with the applicable regulations.

■ Handling Your Digital Camera

This camera contains precision electronic components. To ensure that images are recorded correctly, do not subject the camera to impact or shock while an image is being recorded.

■ Trademark Information

-  and xD-Picture Card™ are trademarks of Fuji Photo Film Co., Ltd.
 - IBM PC/AT is a registered trademark of International Business Machines Corp. of the U.S.A.
 - Macintosh, Power Macintosh, iMac, PowereBook, iBook and Mac OS are trademarks of Apple Computer, Inc., registered in the U.S. and other countries.
 - QuickTime and the QuickTime logo are trademarks used under license. The QuickTime logo is registered in the U.S. and other countries.
 - Adobe Acrobat® Reader® is a trademark of Adobe Systems Incorporated of the U.S.
 - Microsoft, Windows, and the Windows logo are trademarks, or registered trademarks of Microsoft Corporation in the United States and/or other countries. Windows is an abbreviated term referring to the Microsoft® Windows® Operating System.
- * The "Designed for Microsoft® Windows® XP" logo refers to the camera and the driver only.
- Other company or product names are trademarks or registered trademarks of the respective companies.

■ Explanation of Color Television System

NTSC : National Television System Committee, color television telecasting specifications adopted mainly in the U.S.A., Canada and Japan.

PAL : Phase Alternation by Line, a color television system adopted mainly by European countries and China.

■ Exif Print (Exif ver. 2.2)

Exif Print Format is a newly revised digital camera file format that contains a variety of shooting information for optimal printing.

Accessories included

- LR6 AA-size alkaline batteries (4)

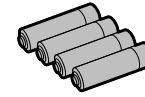

- 16 MB, xD-Picture Card™ (1)
included with : Anti-static case (1)



- Shoulder strap (1)



- Adapter Ring : AR-FX5 (1)

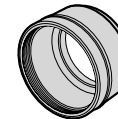

- Lens Cap (1)



- A/V Cable for FinePix S5000
(approx. 1.5 m (4.9 ft.), plug (2.5 mm dia.)
to pin-plug cable ×2) (1)

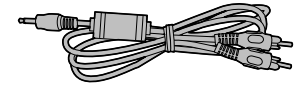

- USB cable (Mini-B) (1)

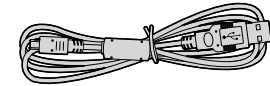

- CD-ROM : Software for FinePix SX (1)

- Owner's Manual (this manual) (1)

Nomenclature

* Refer to the pages in parentheses for information on using the camera features.

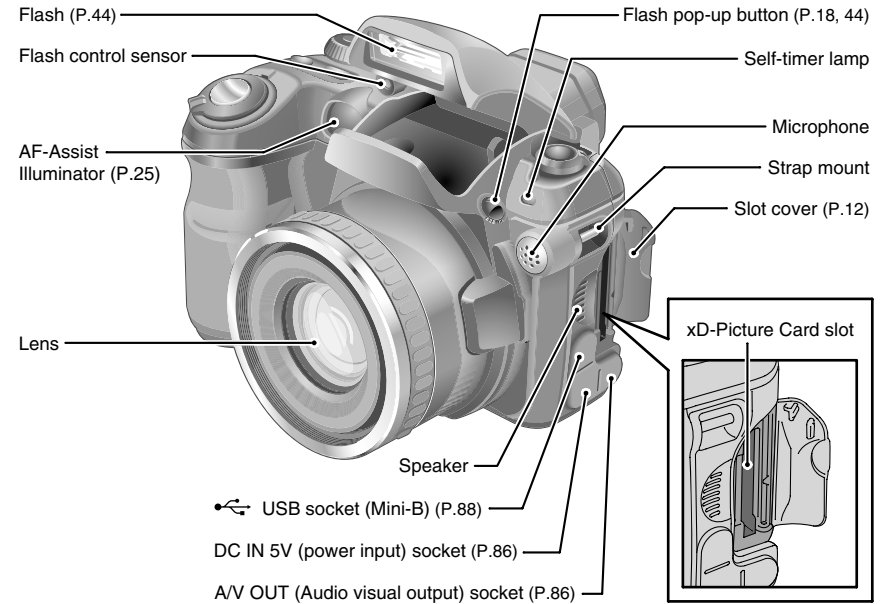
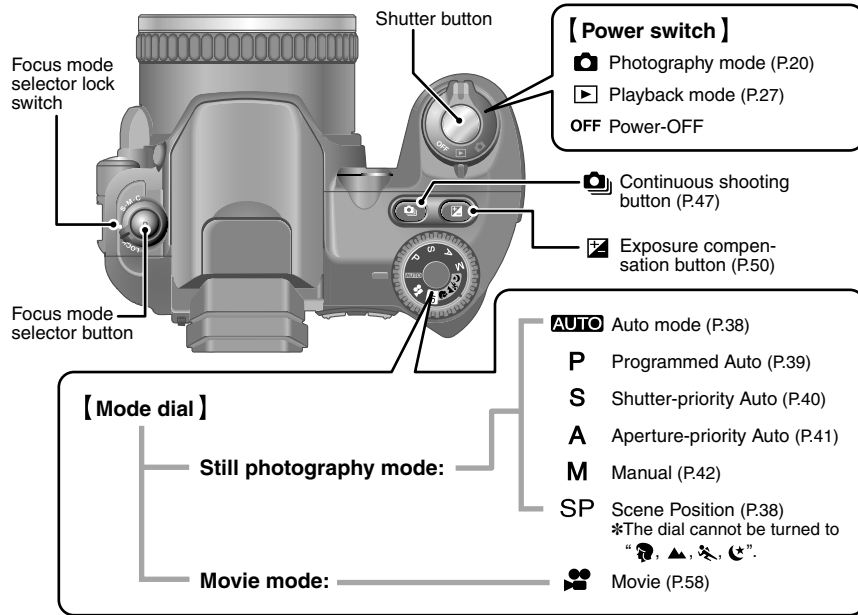

Example of Monitor Text Display

■ Still photography mode

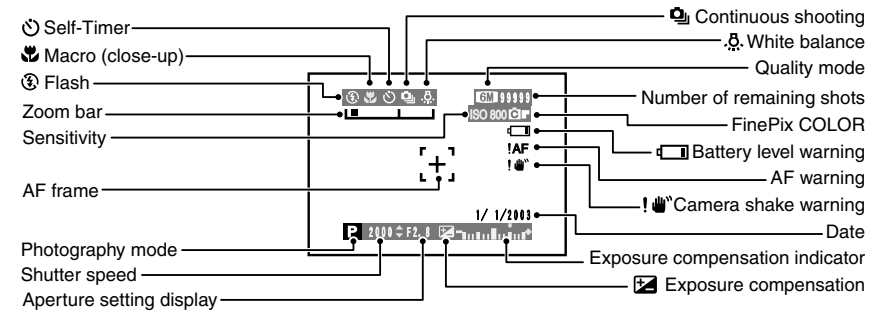

■ Playback mode

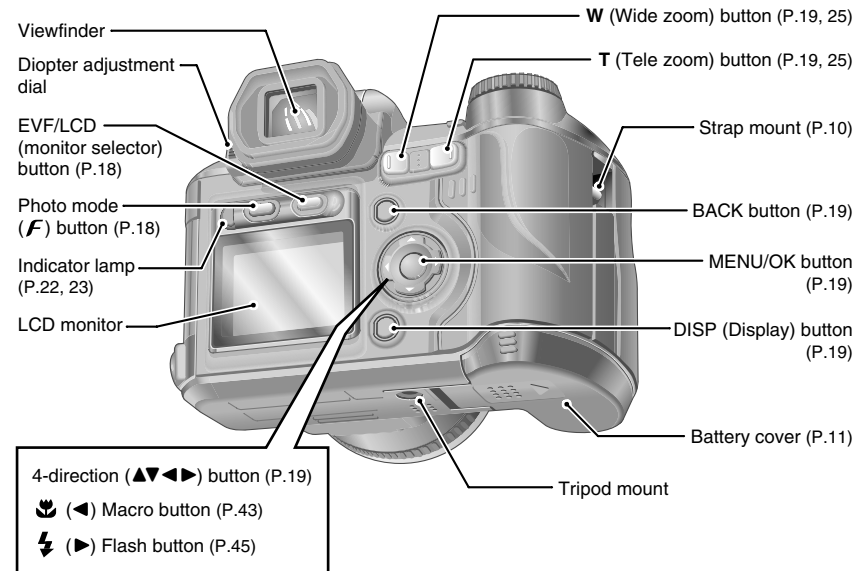
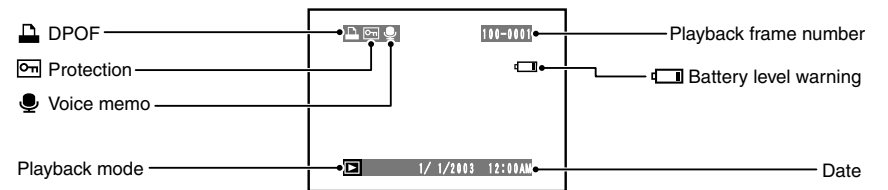

1 Getting Ready

ATTACH THE LENS CAP/STRAP/ADAPTER RING

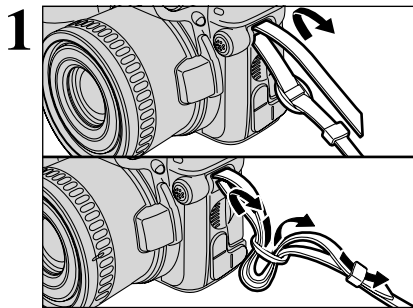

Attach the strap to the strap mounts on the camera. Once you have attached both ends of the strap, check carefully to ensure that the strap is firmly secured.

⚠ Failure to attach the strap correctly can result in the camera being dropped.

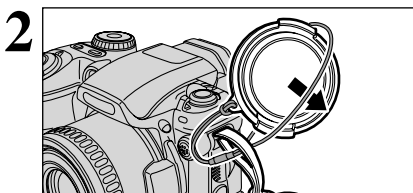

Pull the lens cap cord through the strap.

⚠ Attach the lens cap cord to avoid losing the lens cap.

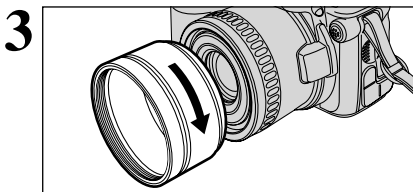

Screw the adapter ring in the direction of the arrow to mount it on the camera.

Mounting the adapter ring on the camera not only blocks unwanted external light but also protects the lens and allows the optional conversion lens to be attached. Mount the adapter ring on the camera at all times.

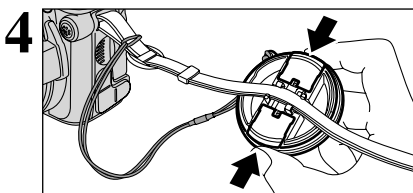

Attaching the lens cap

To prevent the lens cap from appearing in the shot when you take pictures, attach the lens cap to the strap.

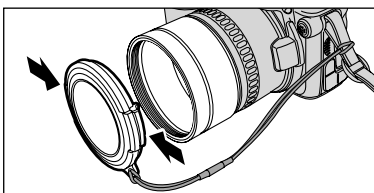

Attach the lens cap to the lens by pressing in on each side of the cap.

LOADING THE BATTERIES

Compatible batteries

- AA-size alkaline batteries (4), or optional AA-size Ni-MH batteries (4).
- ⚠ Please use the same brand and grade AA-size alkaline batteries as those supplied with the camera.

How to use the battery

- Never use the following types of battery, as this could cause serious problems such as battery fluid leakage or overheating:
 1. Batteries with split or peeling outer casings
 2. Combinations of different types of batteries or new and used batteries together
- Do not use manganese or Ni-Cd batteries.
- Soil, such as fingerprints on the poles of the batteries can significantly reduce the amount of time for which the batteries can be used.
- The time for which AA-size alkaline batteries (referred to hereafter simply as alkaline batteries) can be used varies depending on the brand, and some alkaline batteries may stop providing power more quickly than those supplied with the camera. Note also that due to their nature, the time for which alkaline batteries can be used decreases in cold conditions (0°C to +10°C). The use of AA-size Ni-MH batteries is recommended for this reason.
- Use Fujifilm Battery charger (sold separately) to charge AA-size Ni-MH batteries.
- See P.97-99 for other notes on using batteries.
- When first purchased or if left unused for a long period, the time for which AA-size Ni-MH batteries or rechargeable Battery NH-10 can be used may be shorter. See P.98 for details.

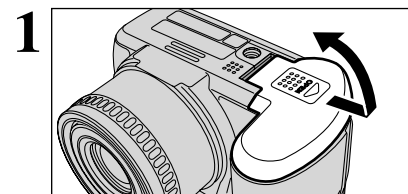
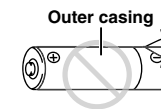

Check that the camera is switched off (indicator lamp switches off) before opening the battery cover.

- ⚠ If you open the battery cover while the camera is switched on, the camera is switched off.
- ⚠ Do not apply excessive force to the battery cover.

Do not open the battery cover while the camera is still switched on. This could damage the xD-Picture Card or corrupt the image files on the xD-Picture Card.

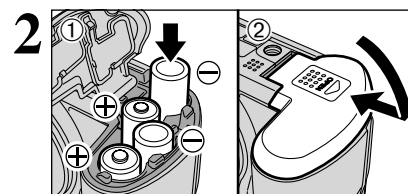

- ① Load the batteries correctly as shown.
- ② Press the batteries down with the battery cover while sliding the battery cover closed.

LOADING THE MEDIA

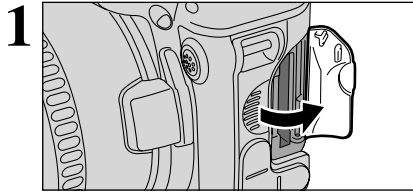

Set the Power switch to "OFF", check that the indicator lamp is off and then open the slot cover.

⚠ If you open the slot cover while the camera is still switched on, the camera is switched off as a safety measure.

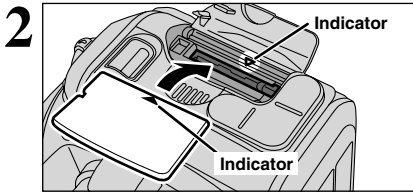

Align the indicators on the xD-Picture Card slot and **xD-Picture Card** and then push the card firmly all the way into the slot.

⚠ The **xD-Picture Card** will not slide fully into the slot if it is inserted facing the wrong way. Be careful not to apply undue force to the **xD-Picture Card**.

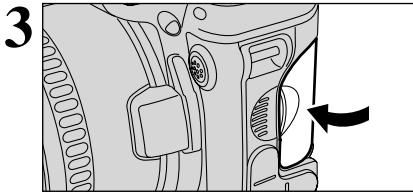

Close the slot cover.

◆ When you want to replace the xD-Picture Card ◆

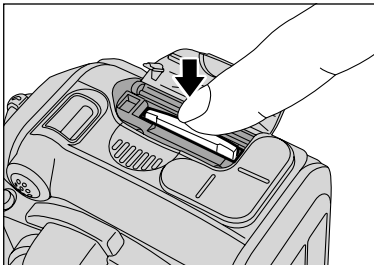

Ensure that the camera is switched off before opening the slot cover. When the **xD-Picture Card** is pushed into the slot and then slowly released, the card lock releases and the **xD-Picture Card** is pushed out.

◆ Checking the remaining battery charge ◆

Switch the camera on and check that no battery level warning (🔋 or 🔋) is displayed on the screen. If no icon is displayed, there is ample charge left in the batteries.

- ① No icon
- ② 🔋 Lit red
- ③ 🔋 Blinking red

- ① There is ample remaining battery charge.
- ② The battery charge is low. Have a new set of batteries ready.
- ③ The batteries are exhausted. The display will shortly go blank and the camera will stop working. Replace or recharge the batteries.

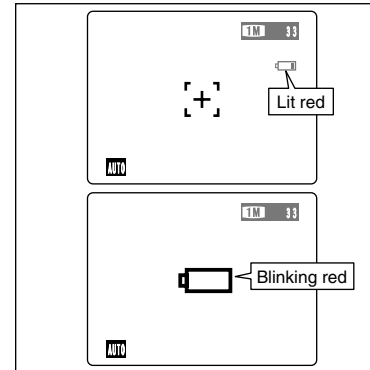

"🔋" is displayed as a small icon on the right-hand side of the screen. "🔋" appears as a large icon in the center of the screen.

- ⚠ The information above is an approximate guide for photography mode. Depending on the camera mode and the type of batteries used, the transition from "🔋" to "🔋" may occur more quickly.
- ⚠ When the batteries runs flat, "🔋" is displayed and camera operation automatically stops. When this occurs, the camera may work if you switch it on again even without loading new or fully charged batteries. However, this may cause camera faults such as the camera switching itself off without retracting the lens. Always load new or fully charged batteries.
- ⚠ Due to the nature of the battery, the battery low warning may appear early when the camera is used in cold locations. This is normal and does not indicate a fault. Try warming the batteries in your pocket or a similar location before use.

◆ Power save function ◆

When this function is active, it also switches off the LCD monitor to reduce power consumption if the camera is not used for 30 seconds (See P.75 for details). If the camera is then left unused for a further period (2 minutes or 5 minutes), the Power save function automatically switches the camera off. To switch the camera back on, turn the Power switch to turn the camera off briefly and then turn it back on.

SWITCHING ON AND OFF/SETTING THE DATE AND TIME

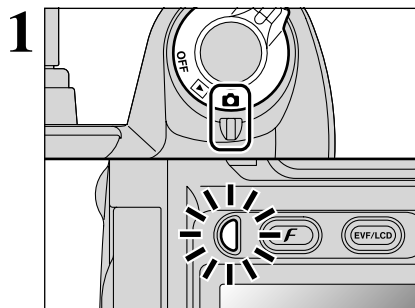

1 Turn the Power switch to turn the camera on and off. When you switch the camera on, the indicator lamp lights (green).

In "CAMERA" mode, the lens extends. Because this operation involves precision mechanisms, take care not to obstruct the lens with your hand or fingers. Obstructing the lens will cause a malfunction or fault and the "ZOOM ERROR" or "FOCUS ERROR" message will appear. Take care also not to get fingerprints on the camera lens as this will result in impaired image quality in your shots.

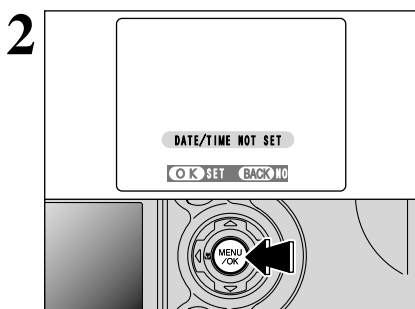

2 When you first switch the camera on, the date is cleared. Press the "MENU/OK" button to set the date and time.

- To set the date and time later, press the "BACK" button.
- If you do not set the date and time, this confirmation message will appear each time you switch the camera on.

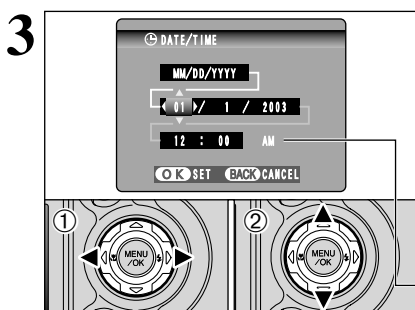

3 ① Press "◀" or "▶" to select Year, Month, Day, Hour or Minute.
② Press "▲" or "▼" to correct the setting.

- If you hold down "▲" or "▼", the numbers change continuously.
- When the time displayed passes "12:00", the AM/PM setting automatically switches.

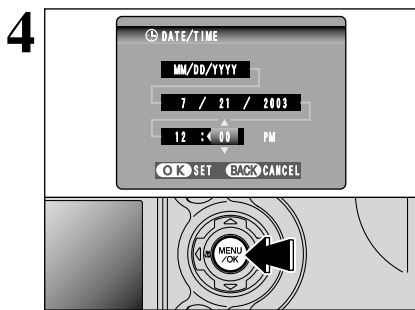

4 Once you have set the date and time, press the "MENU/OK" button. Pressing the "MENU/OK" button switches the camera to Photography or Playback mode.

- Camera settings such the date and time are cleared when you first purchase the camera and if you leave the camera for a long period with the battery removed. Once the AC power adapter has been connected or the batteries has been fitted for 2 hours or more, the camera settings will be retained for roughly 6 hours even if both sources of camera power are removed.

CORRECTING THE DATE AND TIME/CHANGING THE DATE ORDER

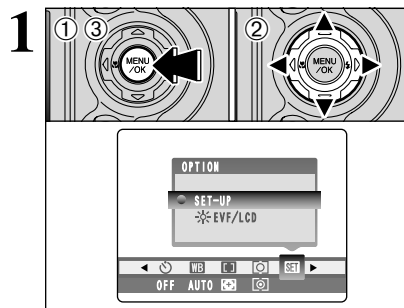

1 ① Press the "MENU/OK" button.
② Press "◀" or "▶" to select "SET" OPTION and then press "▲" or "▼" to select "SET-UP".
③ Press the "MENU/OK" button.

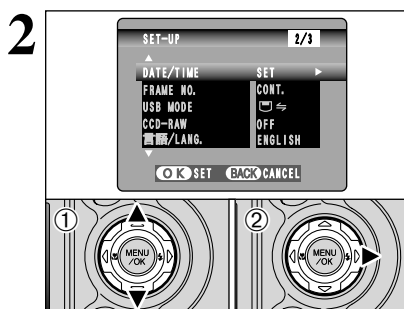

2 ① Press "▲" or "▼" to select "DATE/TIME".
② Press "▶".

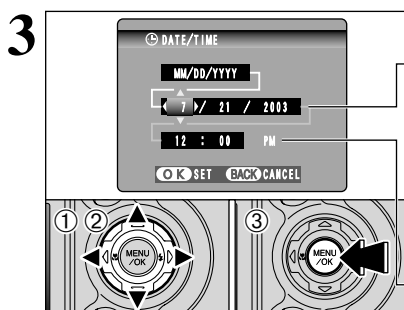

3 **Changing the date and time**
① Press "◀" or "▶" to select Year, Month, Day, Hour or Minute.
② Press "▲" or "▼" to correct the setting.
③ Always press the "MENU/OK" button after you complete the settings.

- If you hold down "▲" or "▼", the numbers change continuously.
- When the time displayed passes "12:00", the AM/PM setting automatically switches.

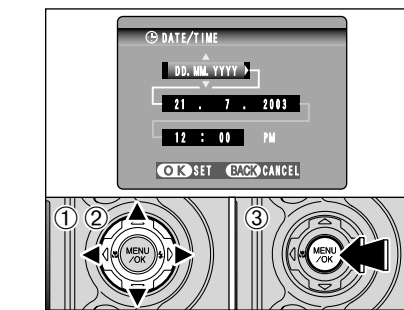

To change the date order
① Press "◀" or "▶" to select the date order.
② Press "▲" or "▼" to set the format. Refer to the table below for details of the settings.
③ Always press the "MENU/OK" button after you complete the settings.

Setting	Explanation
YYYY.MM.DD	Displays the date in the "year. month. day" format.
MM/DD/YYYY	Displays the date in the "month/day/year" format.
DD.MM.YYYY	Displays the date in the "day. month. year" format.

SELECTING THE LANGUAGE

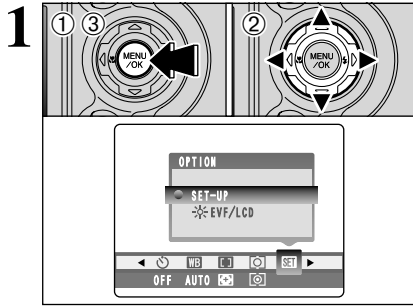

- ① Press the "MENU/OK" button to display the menu screen.
- ② Press "▲", "▼", "◀" or "▶" to select "SET-UP" from the "OPTION" menu.
- ③ Press the "MENU/OK" button.

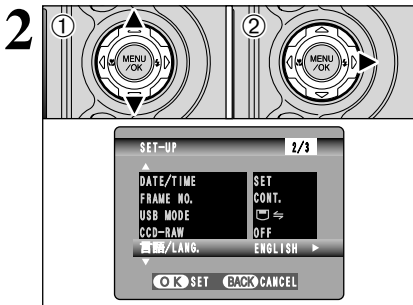

- ① The "SET-UP" screen appears. Press "▲" or "▼" to select "言語/LANG."
- ② Press "▶" to select "ENGLISH", "FRANCAIS", "DEUTSCH", "ESPAÑOL", "中文" or "日本語". You can cycle through the language settings by pressing "▶".
- ③ Always press the "MENU/OK" button after you complete the settings.

☞ The screens in this manual are shown in English.
 ☞ See P.73 for more information on the "OPTION" menu.

2 Using the Camera

BASIC OPERATION GUIDE

You've read the chapter on getting ready and the camera is now set up and ready to take pictures. "Using the Camera" describes the basic camera operations of "Taking Pictures", then "Viewing Images" and "Erasing Images".

This section describes the camera's functions.

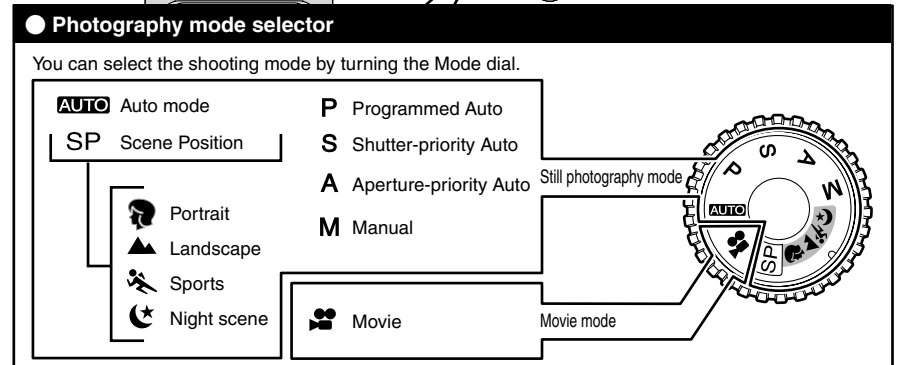
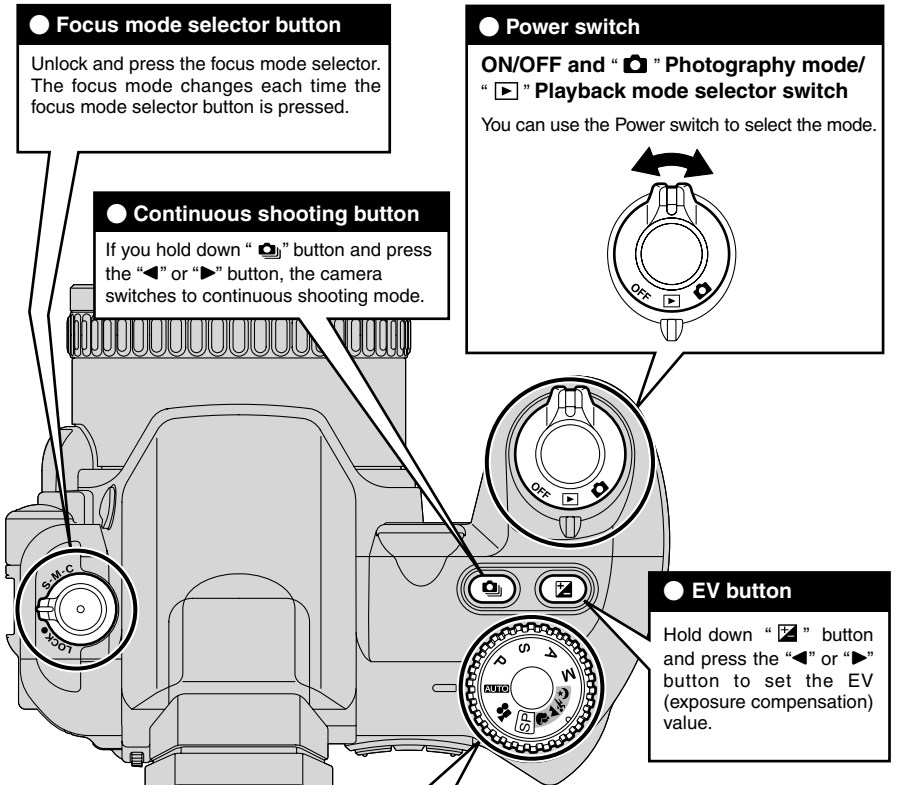

● Diopter adjustment dial
 Makes the image in the viewfinder easier to see. Set the dial to the position where the AF frame appears sharpest.

● Flash pop-up button
 To use the flash, press the Flash pop-up button to release the flash.

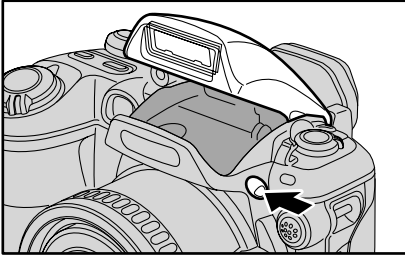
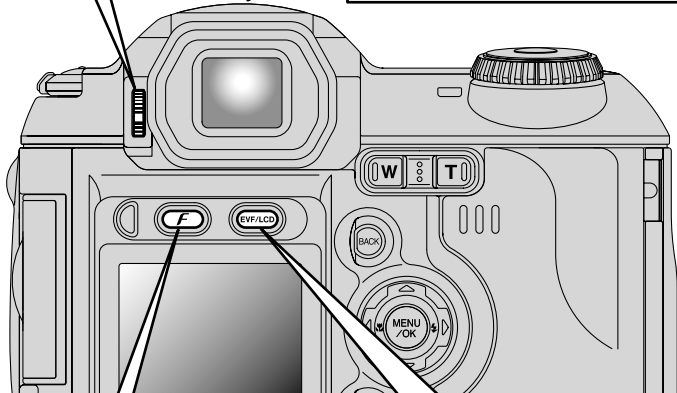
● EVF/LCD (monitor selector) button
 Pressing the "EVF/LCD" button toggles between the viewfinder and the LCD monitor. Use whichever mode is best suited to your shot.

● Photo mode (F) button
Photography: Allows you to select the resolution (Number of recorded pixels), sensitivity and FinePix COLOR settings.
Playback: Allows you to specify the print order (DPOF) settings.



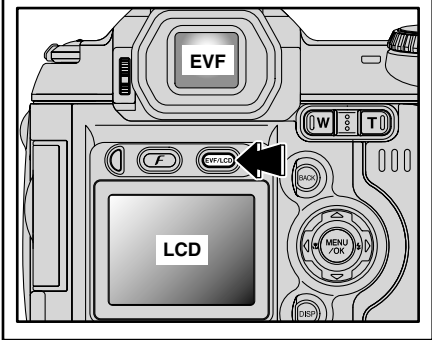



● Zoom button
Photography: Press "T" to zoom in (telephoto-angle). Press "W" to zoom out (wide-angle).
Playback: Press "T" to enlarge the image. Press "W" to revert to normal display.

● BACK button
 Press this button to stop a procedure midway through.

● DISP button
 You can use this button to select the LCD monitor display.
Photography: Switches the LCD monitor on and off or displays the framing guides.
Playback: Switches text display on and off or selects multi-frame playback.

● ◀▶ button
Photography: "◀" button Switches Macro (📍) on and off. "▶" button Sets the flash (⚡).
Playback: Change frame or (in a movie) frame advance.

● Using the menus

- ① Display the menu.
 Press the "MENU/OK" button. 
- ② Select a menu option.
 Press the left or right arrow on the 4-direction button. 
- ③ Select a setting.
 Press the up or down arrow on the 4-direction button. 
- ④ Confirm the setting.
 Press the "MENU/OK" button. 

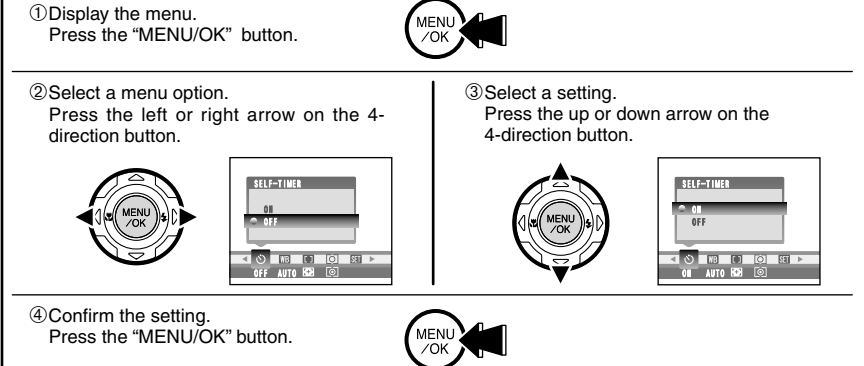

◆ Displaying the On-screen help ◆
 Instructions for the next step in the procedure are displayed at the bottom of the screen. Press the button indicated.
 For example, to crop the image as shown in the figure at right, press the "MENU/OK" button.

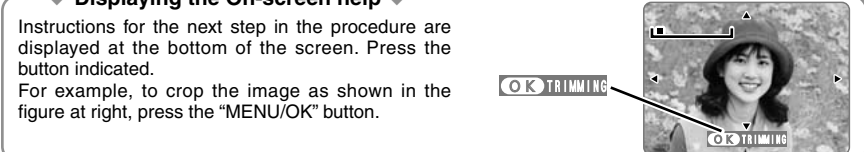

In the Owner's Manual the up, down, left and right directions on the 4-direction button are indicated by black triangles. Up or down is shown as "▲" or "▼", and left or right is shown as "◀" or "▶".

TAKING PICTURES (AUTO MODE)

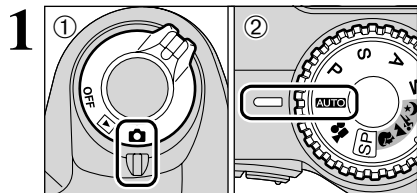

① Set the Power switch to "📷" ② and set the Mode dial to "AUTO".

● **Focal range**

Wide-angle : Approx. 0.9 m (3.0 ft.) to infinity
Telephoto : Approx. 2.0 m (6.6 ft.) to infinity

- ⚡ If the subject is closer than approximately 90 cm (3.0 ft.), set the camera to Macro mode (➡P.43).
- ⚡ If a "CARD ERROR", "WRITE ERROR", "READ ERROR" or "CARD NOT INITIALIZED" message appears, see P.101-102.

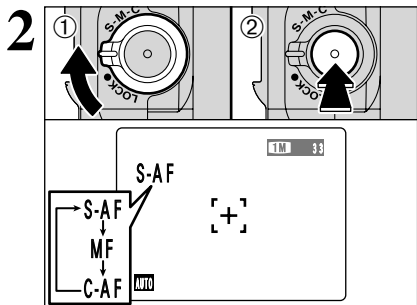

① Unlock the Focus mode selector lock switch.
② Press the Focus mode selector button to set the Focus mode to "S-AF".

- ⚡ See P.51-52 for information on the manual focus "MF" and the continuous AF "C-AF".

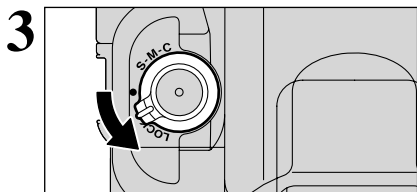

Lock the Focus mode selector lock switch to prevent inadvertent mode changes.

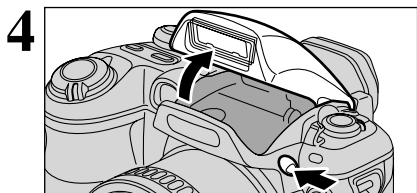

Press the Flash pop-up button to pop up the flash.

- ⚡ When the flash is popped up or you are using the flash to take pictures, you may see the image disappear and the screen go dark as the flash charges. The indicator lamp blinks orange while the flash is charging.
- ⚡ If you use the flash in very dusty conditions or when it is snowing, white dots may appear in the image due to the flash reflecting off the dust particles or snowflakes. Try taking the shot using Suppressed flash mode.

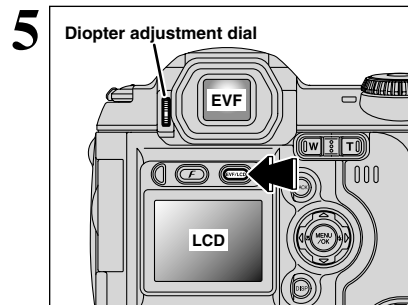

Each time you press the "EVF/LCD" button, display switches between the viewfinder (EVF) and the monitor (LCD). If the AF frame in the viewfinder (EVF) is difficult to see, adjust the viewfinder using the Diopter adjustment dial.

The switched EVF/LCD setting is retained even if you change the mode or switch the camera off.

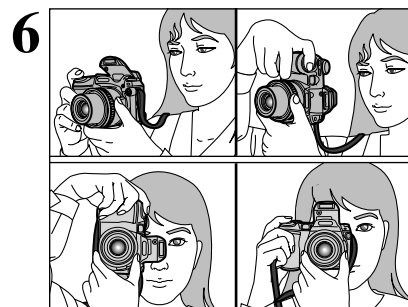

Brace your elbows against your sides and hold the camera with both hands. Position the thumb of your right hand so that it is handy for using the zoom.

- ⚡ The image will be blurred if the camera moves when taking the picture (camera shake). Use a tripod to avoid camera shake, particularly for shots in dark locations when the flash is set to Suppressed Flash mode.
- ⚡ There may be some unevenness in the brightness at the lower edge of the LCD monitor. This is normal and does not indicate a fault. This does not affect the photographed image.

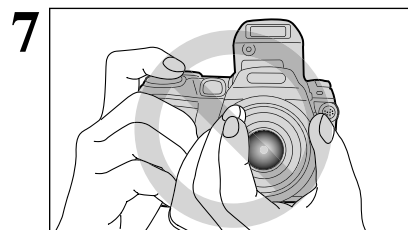

Take care to hold the camera so that your fingers or the strap do not cover the lens, flash AF-Assist Illuminator or flash control sensor. If the lens, flash or flash control sensor is obscured by your fingers or the camera strap, you may not be able to obtain the correct brightness (exposure) for your shot.

- ⚡ Check that the lens is clean. If it is dirty, clean the lens as described on P.97.

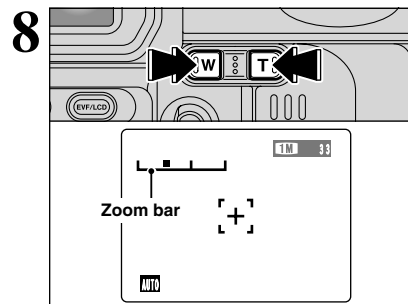

If you want to zoom in on your subject, press "T" (telephoto). To widen the angle of your shot, press "W" (wide-angle). When you do this, the "zoom bar" is displayed on the screen.

● **Optical zoom focal length**
(35 mm camera equivalent)
Approx. 37 mm to 370 mm
Max. zoom scale : 10x

- ⚡ Zooming pauses briefly when it switches between optical zoom and digital zoom (➡P.25). Press the same zoom button again to switch zoom modes.
- ⚡ The zoom setting is retained even when the camera is switched off.

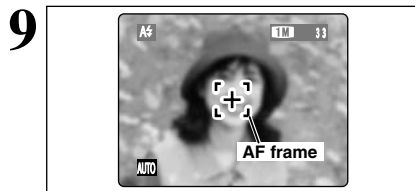

9 Frame the shot so that the subject fills the entire AF (Auto Focus) frame.

☛ If the subject is not in the AF frame, use AF/AE lock to take the picture (⇒P.24).

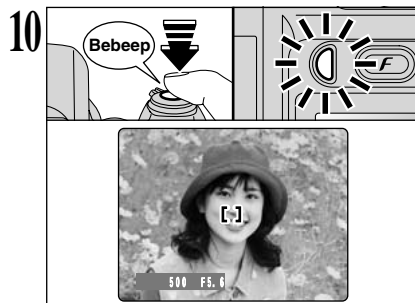

10 When you press the Shutter button down halfway, the camera emits a short double-beep and focuses on your subject. At that point, the AF frame on the screen becomes smaller and the camera sets the shutter speed and aperture (the indicator lamp (green) changes from blinking to steady).

- ☛ The image shown on the screen before you take the shot may differ in its brightness, color, etc. from the image actually recorded. If necessary, play back the recorded image to check it (⇒P.27).
- ☛ For subjects with no clear contrast between dark and light, the camera may not give a short double-beep when the AF frame becomes smaller. However, the shot is still in focus.
- ☛ If the camera does not emit a short double-beep and "!"AF" appears on the screen, the camera cannot focus.
- ☛ When you press the Shutter button down halfway, the image on the screen freezes temporarily. However, this image is not the recorded image.
- ☛ If "!"AF" is displayed on the screen, try standing about 2 m (6.6 ft.) from your subject to take the picture.

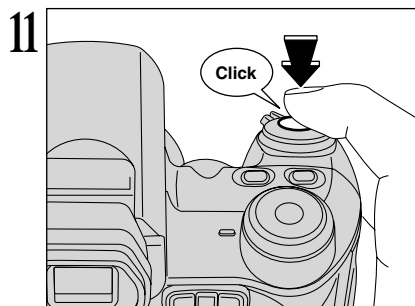

11 If you press the Shutter button down fully without releasing it, the camera makes a clicking noise and takes the picture. The camera then records the photographed image.

- ☛ There is a slight delay between the Shutter button being pressed and the shot being taken. If necessary, playback the shot to check the image.
- ☛ If you press the Shutter button down fully in one motion, the shot is taken without the AF frame changing.
- ☛ When you take the shot, the indicator lamp lights orange (shooting disabled). The indicator lamp then changes to green to indicate that the next picture can be taken.
- ☛ The indicator lamp blinks orange while the flash is charging. The monitor may go dark briefly. This is normal and does not indicate a fault.
- ☛ See P.101-102 for information on the warning displays.

■ **Indicator lamp display**

Display	Status
Lit green	Ready to shoot.
Blinking green	AF/AE in progress, camera shake warning or AF warning (Ready to shoot).
Blinking green and orange alternately	Recording to xD-Picture Card (Ready to shoot).
Lit orange	Recording to xD-Picture Card (Not ready).
Blinking orange	Charging the flash (flash will not fire).
Flashing green (1-second intervals)	Camera in Power save mode (⇒P.75).
Blinking red	<ul style="list-style-type: none"> • xD-Picture Card Warnings No card loaded, card not formatted, incorrect format, card full, xD-Picture Card error. • Lens operation error.

* Detailed warning messages are displayed on the monitor (⇒P.101-102).

◆ **Subjects not suitable for autofocus** ◆

Though the FinePix S5000 uses an accurate autofocus mechanism, it may have difficulty focusing or not be able to focus at all on the types of subjects and situations listed below. In such cases, the image may be out of focus.

- Very shiny subjects such as a mirror or car body.
 - Subjects photographed through glass.
 - Subjects that do not reflect well, such as hair or fur.
 - Subjects with no substance, such as smoke or flames.
 - When the subject is dark.
 - When there is very little contrast between the subject and the background (such as white walls or subjects dressed in the same color as the background).
 - Subjects moving at high speed.
 - When there is a high-contrast subject other than the main subject at or near the center of the image and that subject is closer to or further from the camera than the main subject (as when you photograph someone against a background with strongly contrasting elements).
- For subjects of this type, use AF/AE lock (⇒P.24).

NUMBER OF AVAILABLE FRAMES

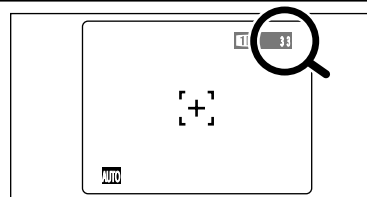

The number of available frames is displayed on the screen.

- ☛ See P.30 for information on changing the Quality mode.
- ☛ The default Quality mode "4" set at shipment is **1M**.

■ **Standard number of frames per xD-Picture Card**

The table below shows the standard number of available frames for a new **xD-Picture Card** formatted on the camera. The larger the **xD-Picture Card** capacity, the greater the divergence between the actual number of available frames and the number shown here. Also, because the amount of data recorded varies depending on the subject, the number of available frames may not decrease or may decrease by 2 when a frame is taken. Consequently, the actual number of available frames may be more or less than what is displayed.

Quality mode	6M	3M	2M	1M	CCD-RAW
Number of recorded pixels	2816 × 2120	2048 × 1536	1600 × 1200	1280 × 960	2816 × 2120
DPC-16 (16 MB)	10	19	25	33	2
DPC-32 (32 MB)	21	40	50	68	4
DPC-64 (64 MB)	43	81	101	137	9
DPC-128 (128 MB)	86	162	204	275	18
DPC-256 (256 MB)	173	325	409	550	37
DPC-512 (512 MB)	347	651	818	1101	75

USING AF/AE LOCK

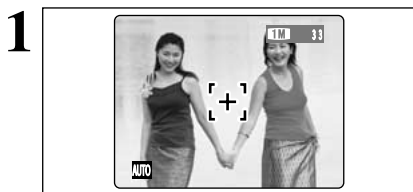

In a shot with this type of composition, the subjects (two people in this case) are not in the AF frame. If the shot is taken at this point, the subjects will not be in focus.

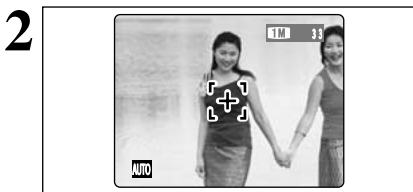

Move the camera slightly so that one of the subjects is in the AF frame.



When you press the Shutter button down halfway, the camera emits a short double-beep and focuses on your subject. At that point, the AF frame on the screen becomes smaller and the camera sets the shutter speed and aperture (the indicator lamp (green) changes from blinking to lit.).

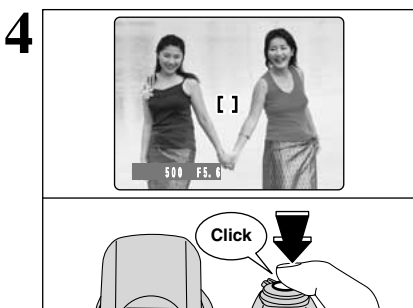

Continue to hold the Shutter button down halfway (AF/AE lock). Move the camera back to the original image and then fully press down on the Shutter button.

- ✔ You can reapply the AF/AE lock as many times as you like before releasing the shutter.
- ✔ The AF/AE lock operates in all Photography modes and can be used to ensure excellent results.

◆ **AF/AE Lock** ◆

On the FinePix S5000, when you press the Shutter button down half way, the focus and exposure settings are fixed (AF/AE lock). If you want to focus on a subject that is off to one side of the image or if you want to set the exposure before you compose the final shot, lock the AF and AE settings and then compose and shoot your picture to get the best results.

AF-ASSIST ILLUMINATOR

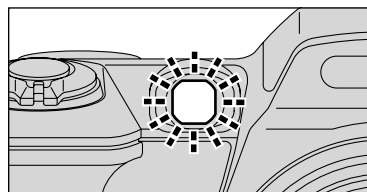

When the Shutter button is pressed down halfway in dimly lit conditions, the camera fires the AF-Assist Illuminator (green) to allow easier focusing at shooting distances of up to roughly 2 m depending on subject. However, the AF-Assist Illuminator is not effective when the zoom is set to telephoto (high magnification : 6x or more). Wherever possible, pictures should be taken using a wide-angle zoom setting (low magnification).

- ✔ When "AF" is displayed even with the AF-Assist Illuminator used, the camera cannot focus. When this occurs, take the picture at a distance of around 2 m from the subject.

USING THE ZOOM (OPTICAL ZOOM/DIGITAL ZOOM)

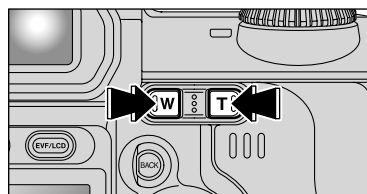

Press the "T" or "W" button to zoom in and out. The digital zoom can be used with the "3M", "2M" and "1M" quality mode setting. When zooming switches between optical and digital, the "■" indicator stops. Pressing the same zoom button again starts the "■" indicator moving again.

- ✔ The digital zoom cannot be used with the "6M" setting.
- ✔ See P.30-31 for information on changing the Quality mode setting.
- ✔ If the shot goes out of focus during zooming, hold the Shutter button down halfway to refocus the shot.

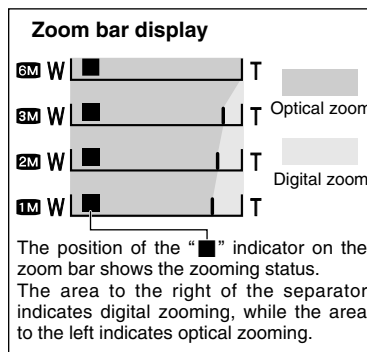

- **Optical zoom focal lengths** (35 mm camera equivalent)
Approx. 37 mm to 370 mm, max. zoom scale : 10x
- **Digital zoom focal lengths** (35 mm camera equivalent)
 - 3M : Approx. 370 mm to 509 mm, max. zoom scale : Approx. 1.4x
 - 2M : Approx. 370 mm to 651 mm, max. zoom scale : Approx. 1.8x
 - 1M : Approx. 370 mm to 814 mm, max. zoom scale : Approx. 2.2x

Using the Camera

BEST FRAMING

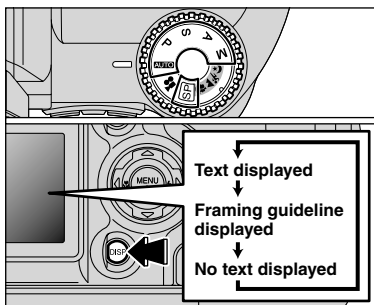

You can select the Framing guideline function in the Still photography mode. The screen display changes each time you press the "DISP" button. Press the "DISP" button until "Framing guideline" appears.

◆ **Important** ◆

Always use AF/AE lock when composing a shot. The image may not be focused correctly if you do not use AE/AF lock.

Scene

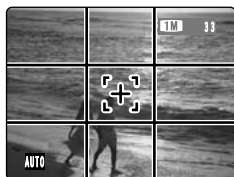

Use this frame with the main subject positioned at the intersection of two lines or align one of the horizontal lines with the horizon.

This frame allows you to compose your own shots while remaining aware of the subject's size and the balance of the shot.

- ⚠ The framing guideline is not recorded on the image.
- ⚠ The lines in the scene frame divide the recorded pixels into 3 roughly equal parts horizontally and vertically. When the image is printed, the resulting print may be shifted slightly from the scene frame.

Single-frame playback

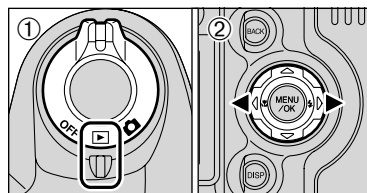

- ① Set the Power switch to "▶".
- ② Press "▶" to scan forward through your images and "◀" to scan backwards.

- ⚠ When you set the Power switch to "▶", your last shot is played back.
- ⚠ If the lens is extended during playback, the lens automatically retracts as a protective measure if the camera is not used for approx. 6 seconds.

Fast-forwarding through your images

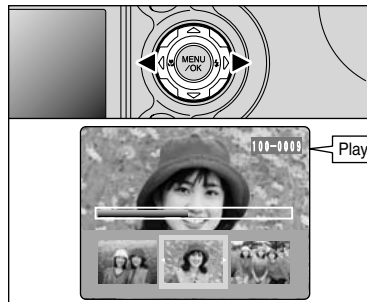

You can scan quickly through your images by holding down "◀" or "▶" for approx. 1 second during playback.

- ⚠ A bar is displayed as a rough guide to the location of the current image on the xD-Picture Card.

Multi-frame playback

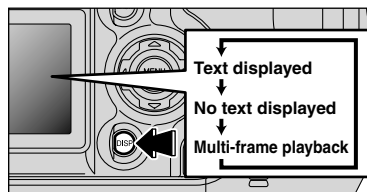

In Playback mode, the display shown on the screen switches each time you press the "DISP" button. Press the "DISP" button until the multi-frame playback screen (9 frames) appears.

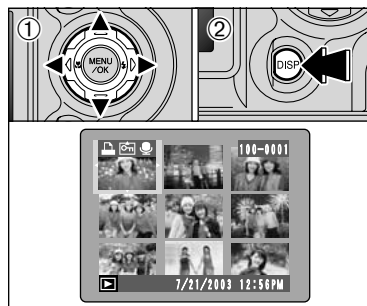

- ① Press "▲", "▼", "◀" or "▶" to move the cursor (orange frame) to the frame you want to select. Pressing "▲" or "▼" repeatedly switches to the next page.
- ② You can enlarge the current image displayer by pressing the "DISP" button again.

◆ **Still images that can be viewed** ◆

You can use this camera to view still images recorded on the FinePix S5000 or still images (excluding some uncompressed images) recorded on a FUJIFILM digital camera that supports xD-Picture Cards.

Single-frame playback

Press the "BACK" button to cancel playback zoom.

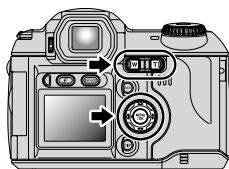

Playback zoom

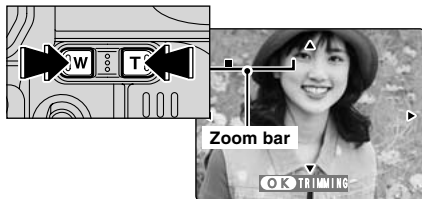

Pressing the "T" or "W" button during single-frame playback zooms (enlarges) the still image. When you do this, a zoom bar is displayed.

● **Zoom scales**

- 6M 2816 × 2120 pixel images : Max. 18×
- 3M 2048 × 1536 pixel images : Max. 13×
- 2M 1600 × 1200 pixel images : Max. 10×
- 1M 1280 × 960 pixel images : Max. 8×

⚠ You cannot use multi-frame playback during playback zoom.

Panning

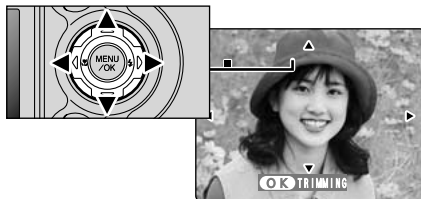

You can view another area by pressing "▲", "▼", "◀", or "▶".

The size of the saved image varies depending on the zoom ratio. If the image size is 1M or less, the "OK TRIMMING" display disappears and you cannot save the image trimmed. For CCD-RAW files, "OK TRIMMING" is not displayed and trimmed images cannot be saved.

Trimming

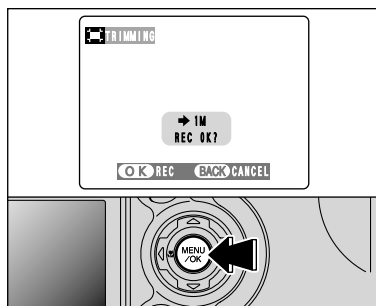

Check the size of the saved image and press the "MENU/OK" button. The cropped image is added as a separate file in the final frame.

■ **Image Sizes**

3M	Best for A5 to A4 size prints
2M	Best for A6 to A5 size prints
1M	Best for A6 size prints

1

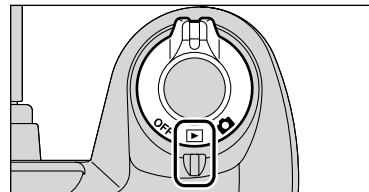

Set the Power switch to "I".

2

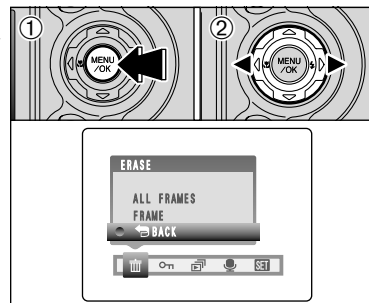

- ① Press the "MENU/OK" button during playback to display the menu.
- ② Press "◀" or "▶" to select "ERASE".

Note that mistakenly erased frames (files) cannot be recovered. You should back up important frames (files) that you do not want to be erased onto your computer or other media.

3

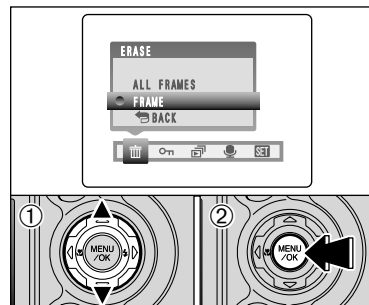

- ① Press "▲" or "▼" to select "FRAME".
 - ② Press the "MENU/OK" button to confirm the selection.
- See P.61 for information on "ALL FRAMES".

- ⚠ Press "▲" or "▼" to select "BACK" and press "MENU/OK" button to return to single-frame playback.
- ⚠ Press the "BACK" button to cancel erasing single frame.

4

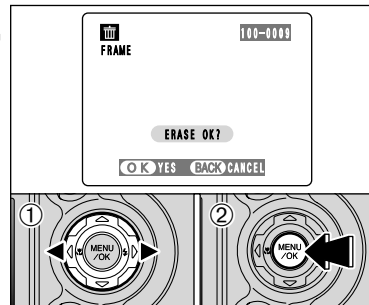

- ① Press "◀" or "▶" to select the frame (file) to be erased.
 - ② Press the "MENU/OK" button to erase the displayed frame (file).
- To erase another image, repeat steps ① and ②.

⚠ Pressing the "MENU/OK" button repeatedly erases consecutive images. Take care not to erase an image by mistake.

QUALITY MODE (NUMBER OF RECORDED PIXELS)

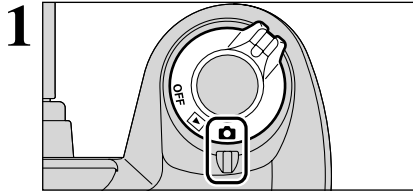

Set the Power switch to "📷".

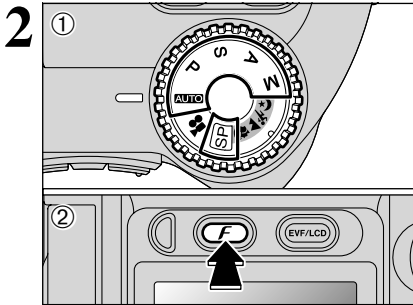

- ① Set the Mode dial to Still photography mode.
- ② Press the Photo mode "F" button.

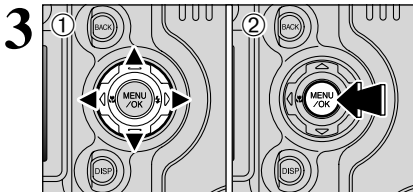

- ① Press "◀" or "▶" to select the "QUALITY" setting and then press "▲" or "▼" to change the setting.
- ② Press the "MENU/OK" button to confirm the setting.

Quality settings in Still photography mode



You can choose from 4 settings. Using the table below as a guide, select the setting that best suits your aims.

- 🔍 The numbers to the right of each setting show the number of available frames.
- 🔍 When you change the quality, the number of available frames also changes (→P.23).

Quality mode	Sample uses
6M 6 MB (2816 × 2120)	Printing at A4 size or printing part of the image cropped at A5 or A6 size.
3M 3 MB (2048 × 1536)	Printing at A4 or A5 size or printing part of the image cropped at A6 size.
2M 2 MB (1600 × 1200)	Printing at A5 or A6 size.
1M 1 MB (1280 × 960)	Printing at A6 size.

Quality setting in High-sensitivity mode

If you try to select a quality setting other than "1M" when the camera is set to High-sensitivity mode, "ISO 8000" is displayed blinking and the quality cannot be changed.

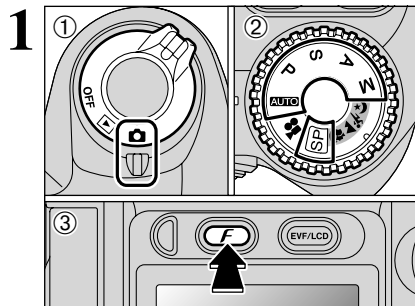

- 1 Set the Power switch to "📷".
- 2 Set the Mode dial to Still photography mode.
- 3 Press the Photo mode "F" button.

The ISO setting remains at high-sensitivity even if using the Power switch or Mode dial.

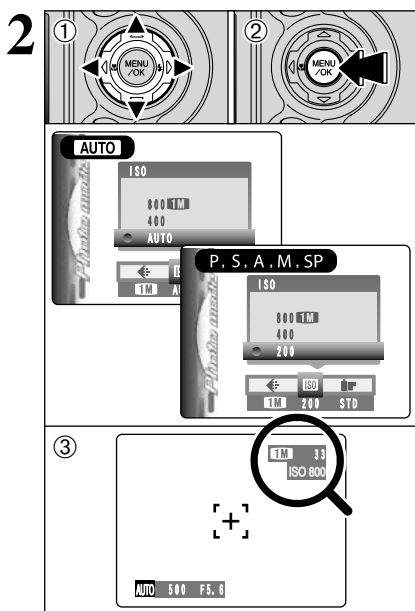

- 1 Press "◀" or "▶" to select the "ISO" setting and then press "▲" or "▼" to change the setting.
- 2 Press the "MENU/OK" button to confirm the setting.
- 3 The selected sensitivity is displayed on the screen (except when the AUTO setting is selected).

● **Settings**

AUTO : AUTO, 400, 800
P, S, A, M, SP : 200, 400, 800

- ⚠ When setting CCD-RAW (⇒P.76), only the "200" and "400" sensitivity settings can be selected.
- ⚠ While selecting a higher sensitivity setting will allow you to take pictures in darker locations, it will also increase the amount of speckling in your images. Streaking may also be visible in shots of scenes such as the night sky. Choose the sensitivity setting that best suits the conditions.

Selecting AUTO as the ISO setting, the camera automatically selects the appropriate ISO setting for the subject brightness. The AUTO ISO setting can be selected in the "AUTO" photography modes.

High-sensitivity photography (800)

When a high-sensitivity (800) is selected, the quality is automatically set to "TM".

- ⚠ The high-sensitivity photography cannot be selected when setting CCD-RAW (⇒P.76).
- ⚠ When you specify a high sensitivity, the amount of noise (interference) in the image shown on the screen before the shot is taken increases. However, this is normal and does not indicate a fault.
- ⚠ The digital zoom cannot be used in high-sensitivity photography.

◆ **Quality setting in High-sensitivity mode** ◆

If you try to select a quality setting (⇒P.30-31) other than "TM" when the camera is set to High-sensitivity mode, "ISO 800" is displayed blinking and the quality cannot be changed.

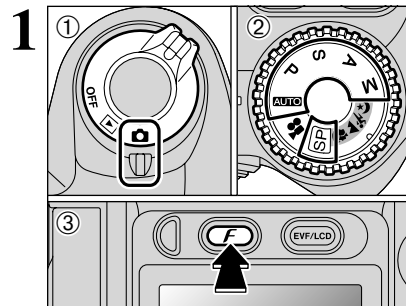

- 1 Set the Power switch to "📷".
- 2 Set the Mode dial to Still photography mode.
- 3 Press the Photo mode "F" button.

The FinePix COLOR setting is retained even if you switch the camera off or change the Mode dial setting.

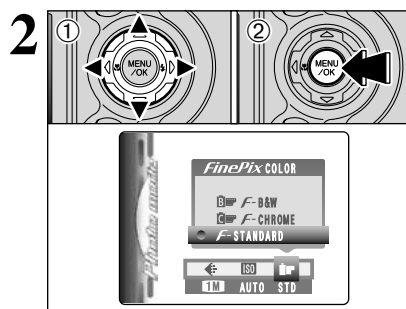

- 1 Press "◀" or "▶" to select the "FinePix COLOR" setting and then press "▲" or "▼" to change the setting.
- 2 Press the "MENU/OK" button to confirm the setting.

- ⚠ F-CHROME may have little visible effect with some subjects, such as close-up shots of people (portraits).
- ⚠ Because the effects on the image differ depending on the scene being shot in F-CHROME mode, take pictures in standard mode as well as this mode. Note that you may not be able to see any difference on the screen.
- ⚠ For shots taken in F-CHROME mode, automatic quality adjustment will be suppressed on Exif print compliant printers.

F-STANDARD (STD)	The contrast and color saturation are set to standard. Use this mode for normal photography.
F-CHROME (CHR)	The contrast and color saturation are set to high.
F-B&W (B&W)	This setting converts the colors in the photographed image to black and white.

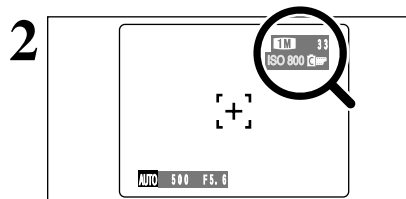

When setting F-STANDARD or F-CHROME, the icon appears on the screen.

F-CHROME :

F-B&W :

FOCUSING

The distance from the subject to the camera is referred to as the shooting distance. The image is said to be focused when the image appears sharp at the correct shooting distance.

■ **Three focusing methods**

The FinePix S5000 now offers a choice of 3 focusing mechanisms : Auto focus (S-AF), Continuous AF (C-AF) and Manual focus (M-AF).

S-AF : Allows the camera to focus on the subject automatically. The camera focuses when the Shutter button is pressed down halfway.

C-AF : The camera focuses continuously on the main subject in the AF frame. Use this mode to photograph moving subjects. See P.51 for details.

MF : With the "M" button held down, press the "T" or "W" button to focus the shot. See P.52 for details.

■ **Causes of focusing errors and the solutions**

Cause	Solution
The subject is not suited to AF.	Use AF lock (Focus mode : AF (CENTER)) *1 or MF.
The subject is outside the shooting range.	Switch Macro mode on or off *2.
The subject is moving too quickly.	Use MF (pre-setting the shooting distance for a shot (lock pin))

*1 Taking pictures using AF lock

Press the Shutter button down halfway to focus.

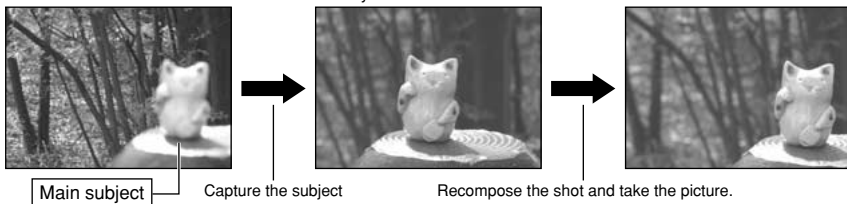

*2 Switching Macro mode ON/OFF

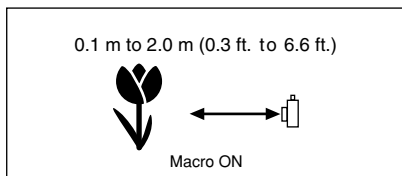
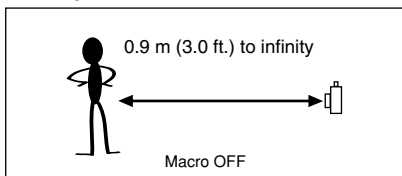

◆ **Subjects Not suitable for Auto focus** ◆

- Very shiny subjects such as a mirror or car body.
- Subjects photographed through glass.
- Subjects that do not reflect well, such as hair or fur.
- Subjects with no substance, such as smoke or flames.
- When the subject is dark.
- When there is very little contrast between the subject and the background (such as white

- walls or subjects dressed in the same color as the background).
- Subjects moving at high speed.
- When there is a high-contrast subject other than the main subject at or near the center of the image and that subject is closer to or further from the camera than the main subject (as when you photograph someone against a background with strongly contrasting elements).

EXPOSURE

Exposure refers to the light that hits the CCD or the total amount of captured light and determines the brightness of the image.

The exposure is determined by the combination of aperture and shutter speed. In AE (automatic exposure), the camera automatically determines the correct exposure, allowing for factors such as the brightness of the subject and the ISO setting.

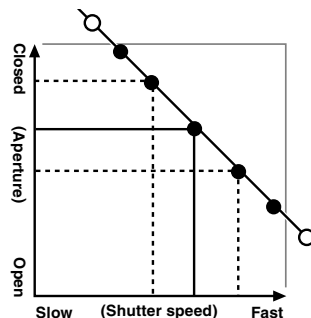

The graph at left shows the way the aperture and shutter speed settings can be changed while maintaining the same exposure level.

- When the exposure is decreased by one step, the shutter speed also decreases by one step (the dot moves up and left).
- When the exposure is increased by one step, the shutter speed also increases by one step (the dot moves down and right).
- Combinations that result in the shutter speed or aperture being outside the available range of settings cannot be selected (white dots).
- In the "P", "S" and "A" photography modes, it is easy to select different settings along this line.
- Selecting settings that run parallel to this line by adjusting the brightness of the photographed image is referred to as exposure compensation.

◆ **When you cannot get the correct exposure** ◆

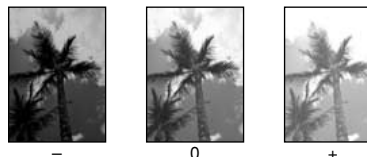

Exposure compensation :

This function uses the exposure level set by the AE function as a reference (0) and then brightens (+) or darkens (-) the image. By selecting Auto bracketing, you can shoot 3 frames, one underexposed (-), one at the reference exposure (0) and one overexposed (+).

Shutter speed

When you are shooting a moving subject, you can either "freeze the motion" or "capture the sense of movement" by adjusting the shutter speed.



Aperture

By adjusting the aperture, you can change the depth of focus (depth of field).

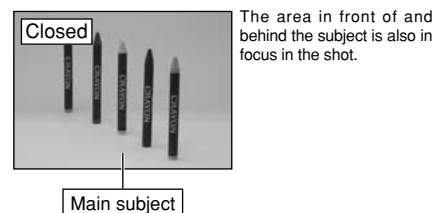

TAKING PICTURES — SELECTING THE CAMERA SETTINGS

Consider the scene you are photographing and the sort of image you want to achieve when you specify the camera settings. A general guide to the procedure is given below.

1 Select the Photography mode (⇒P.38-42, 58-59).

AUTO All settings other than the Quality, ISO sensitivity and FinePix COLOR are specified on the camera.

SP Select the best Scene position setting (👤PORTRAIT, ▲SCENE, 🏃SPORT or 🌃NIGHT) for the scene being shot.

P/S/A Allows you to change the aperture or shutter speed setting so that the action is frozen, so that the flow of the motion is conveyed, or so that the background is out of focus.

M Allows you to adjust all the camera settings yourself.
Shoots a movie.

2 Specify the required photography function settings (⇒P.43-52).

🔍 Macro Use these functions for close-up shots.

⚡ Flash Use the flash for shots in dark locations or for backlit subjects, etc.

📹 Continuous shooting Allows you to take a series of continuous shots or to use auto bracketing (with exposure compensation).

☑ Exposure compensation Using the AE exposure as a reference value of 0, this function brightens (+) or darkens (-) the shot.

3 Take the photograph (check the exposure and focus ⇒ adjust the shot composition ⇒ press the Shutter button down fully).

★ You can use the menus for more detailed settings (⇒P.30-33, 53-57).

The table below provides a number of sample settings. You can achieve any number of other effects by using the settings effectively. Try changing different settings to see what kind of shots you can take.

To achieve this result	Sample settings
To express the motion of the subject (the flow of time)	Set the Mode dial to "S" and select a slow shutter speed. (Use a tripod to avoid camera shake.)
To freeze the subject's movement	Set the Mode dial to "S" and select a fast shutter speed.
To make the subject stand out by having the background out of focus	Set the Mode dial to "A" and select a wide aperture setting.
To get a very large depth of focus	Set the Mode dial to "A" and select a narrow aperture setting.
To prevent the image having a red or blue cast due to the light source	Change the "White balance" setting in the photography menu.
To avoid missing snapshot opportunities	Take pictures in AUTO mode (see "Using the Camera").
To prevent the subject from being overexposed or underexposed and to show the substance and textures of the subject clearly.	Use exposure compensation. Select (+) if the background is pale and (-) if the background is dark.

List of functions available in each mode

Photography mode	SP					P	S	A	M	👤
	AUTO	👤 PORTRAIT	▲ SCENE	🏃 SPORT	🌃 NIGHT					
Function										
🔍 Macro	YES	NO	NO	NO	NO	YES	YES	YES	YES	NO
⚡ Flash	A4 Auto flash	YES	YES	NO	YES	NO	NO	NO	NO	NO
	👁 Red-eye reduction	YES	YES	NO	NO	NO	YES	YES	YES	NO
	⚡ Forced flash	YES	YES	NO	YES	NO	YES	YES	YES	NO
	⚡ Slow synchro	NO	YES	NO	NO	YES	YES	NO	YES	NO
	👁 Red-eye + slow	NO	YES	NO	NO	YES	YES	NO	YES	NO
📹 Continuous shooting selections	📹 Top 5-frame	YES	YES			YES	YES	YES	YES	NO
	📹 Auto bracketing	NO	NO			YES	YES	YES	YES	NO
	📹 Final 5-frame	YES	YES			YES	YES	YES	YES	NO
	📹 Long-period (up to 40 frames)	YES	NO			NO	NO	NO	NO	NO
Focus mode (S-AF/MF/C-AF)	YES	YES			YES	YES	YES	YES	NO	
☑ Exposure compensation	NO	NO			YES	YES	YES	NO	NO	

* The flash cannot be used for continuous shooting.
* MEGA continuous shooting and high-sensitivity photography cannot be used together.

List of menu options available in each mode

		Factory Defaults	AUTO	SP	P	S	A	M	👤	
FinePix photo mode	👁 Quality	1M	YES	YES	YES	YES	YES	YES	NO	
	ISO ISO	AUTO*1	YES	YES	YES	YES	YES	YES	NO	
	👁 FinePix COLOR	F-STANDARD	YES	YES	YES	YES	YES	YES	NO	
Menu options	🕒 Self-timer	OFF	YES	YES	YES	YES	YES	YES	NO	
	WB White balance	AUTO	NO	NO	YES	YES	YES	YES	NO	
	AF MODE	📹 MULTI	CENTER	NO	NO	YES	YES	YES	YES	NO
		📹 CENTER	CENTER	NO	NO	YES	YES	YES	YES	NO
		📹 AREA	CENTER	NO	NO	YES	YES	YES	YES	NO
	[O] Photometry	[O] MULTI	MULTI	NO	NO	YES	YES	YES	YES	NO
		[.] SPOT	MULTI	NO	NO	YES	YES	YES	YES	NO
		[] AVERAGE	MULTI	NO	NO	YES	YES	YES	YES	NO
	📹 Bracketing	±1/3EV	NO	NO	YES	YES	YES	YES	NO	
	📹 Sharpness	NORMAL	NO	NO	YES	YES	YES	YES	NO	
⚡ Flash (brightness adjustment)	0	NO	NO	YES	YES	YES	YES	NO		

*1 AUTO can only be set in "AUTO" mode.
* High-sensitivity photography cannot be used together with Long-period continuous shooting.
* AREA cannot be used together with continuous AF (C-AF).

When shutter speed and aperture adjustments alone do not give the correct exposure.

When the image is too bright
Lower the "ISO" sensitivity setting.

When the image is too dark
Raise the "ISO" sensitivity setting.
Use flash or the brightness adjustment function.

AUTO AUTO/SP SCENE POSITION

AUTO AUTO

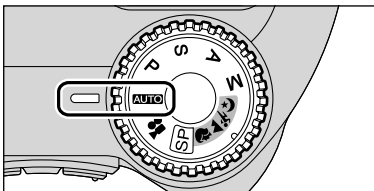

Set the Mode dial to "AUTO". This is the easiest mode to use and can be used for most types of shot.

SP SCENE POSITION

1

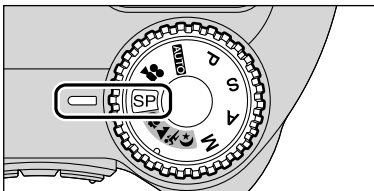

Set the Mode dial to "SP". This mode provides options tailored to different types of scene.

The dial cannot be turned to "P", "A", "S", or "C".

Macro mode cannot be used with any of the "SP" modes.

2

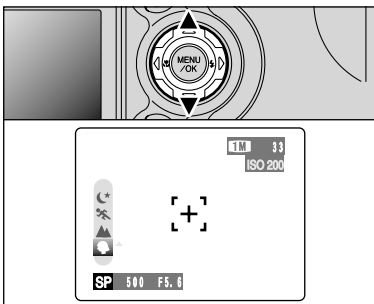

Four types of scene (Portrait, Landscape, Sports, and Night scene) appear on the left side of the screen. Press "▲" or "▼" to select the desired scene.

	Explanation	Available Flash modes
Portrait	This is the best mode for shooting portraits. Skin tones are shown beautifully and the overall tone is soft.	A $\frac{1}{2}$ /A $\frac{1}{4}$ /S $\frac{1}{4}$ /STROB
Landscape	This is the best mode for shooting scenery in daylight and provides crisp, clear shots of scenery such as buildings and mountains.	Flash not available*
Sports	This is the best mode for shooting sporting events. This mode gives priority to faster shutter speeds.	A $\frac{1}{4}$ /A $\frac{1}{2}$
Night scene	This is the best mode for evening and night scenes. This mode allows you to take shots where priority is given to slow shutter speeds of up to 2 seconds. To prevent camera shake, always use a tripod.	S $\frac{1}{4}$ /STROB

* When the flash is popped up, "C" appears.

P PROGRAMMED AUTO

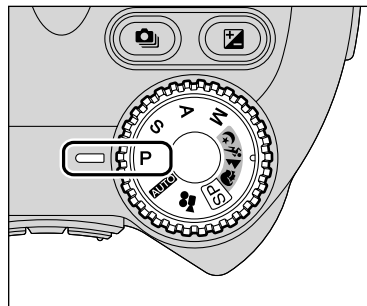

Set the Mode dial to "P". This is an automatic mode that allows you to specify any of the settings other than the shutter speed and aperture. This allows you to take shots relatively simply in the same way as the Shutter-priority auto and Aperture-priority auto modes (program shift).

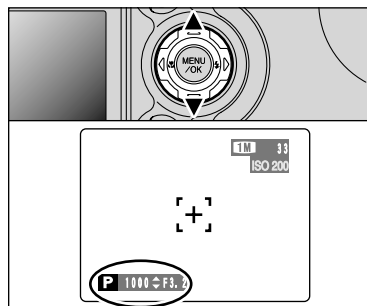

Program shift

This function allows you to change the combination of shutter speed and aperture without changing the exposure setting, simply by pressing the "▲" or "▼". The shutter speed and aperture setting are displayed in yellow when the camera is in Program shift mode.

Program shift is automatically cancelled in the following situations:

- When the Photography mode is changed
- When you switch to Playback mode
- When the camera is switched off.

S SHUTTER-PRIORITY AUTO

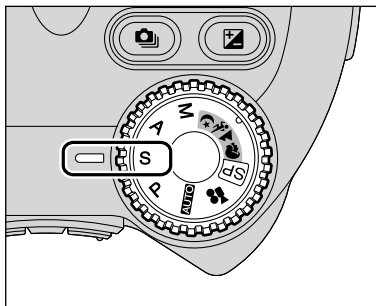

Set the Mode dial to "S".
This is an automatic mode that allows you to set the shutter speed.
You can use this mode for shots where you want to freeze a moving subject (fast shutter speed) or convey the impression of movement (slow shutter speed).

Setting the shutter speed

You can set the shutter speed by pressing the "▲" or "▼".

- **Shutter speed settings**
2 sec. to 1/1000 sec. in 1/3 EV steps

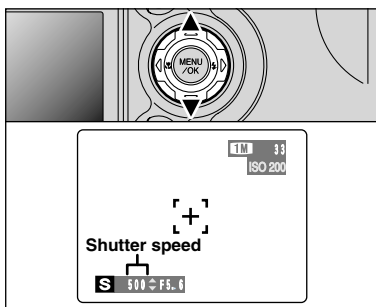

The shutter speed and aperture setting display

Overexposed

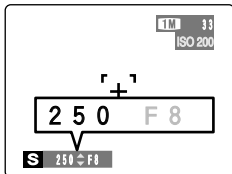

In scenes that are extremely overexposed, the aperture setting is displayed in red. When this occurs, select a faster shutter speed (up to 1/1000 sec.).

Underexposed

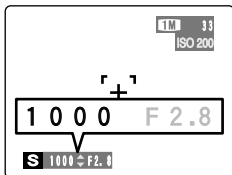

In scenes that are extremely underexposed, the aperture setting is displayed in red. When this occurs, select a slower shutter speed (down to 2 sec.).

Metering failed

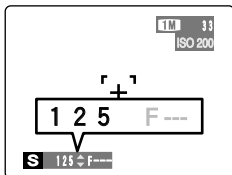

When the brightness of the subject is outside the camera's brightness metering range, "F---" is displayed as the aperture setting. When this occurs, press the shutter button down halfway to measure the light level again and display a value.

A APERTURE-PRIORITY AUTO

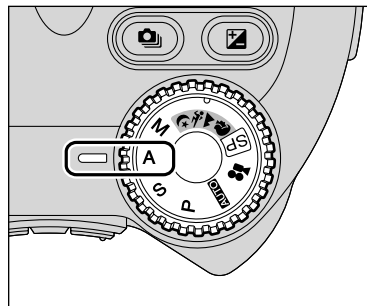

Set the Mode dial to "A".
This is an automatic mode that allows you to set the aperture.
You can use this mode for shots where you want to have the background out of focus (large aperture) or have both near and far objects in focus at the same time (small aperture).

Setting the aperture

You can set the aperture setting by pressing the "▲" or "▼".

- **Aperture settings**
Wide-angle : F2.8 to F8 in 1/3 EV steps
Telephoto : F3.2 to F9 in 1/3 EV steps

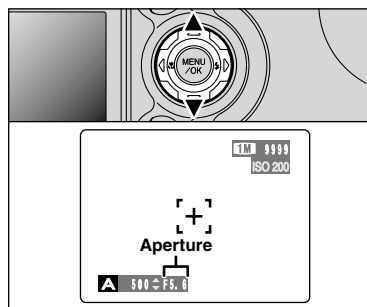

The shutter speed and aperture setting display

Overexposed

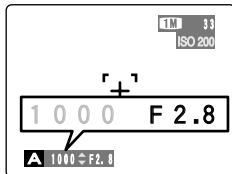

In scenes that are extremely overexposed, the shutter speed setting is displayed in red. When this occurs, select a larger number aperture setting.

Underexposed

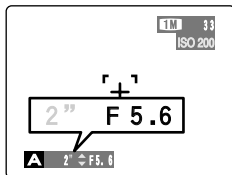

In scenes that are extremely underexposed, the shutter speed setting is displayed in red. When this occurs, select a smaller number aperture setting.

Metering failed

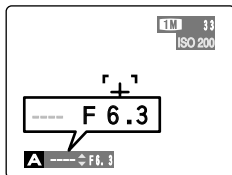

- When Forced flash mode is selected, the slowest available shutter speed is 1/60 sec.

When the brightness of the subject is outside the camera's brightness metering range, "----" is displayed as the shutter speed setting. When this occurs, press the shutter button down halfway to measure the light level again and display a value.

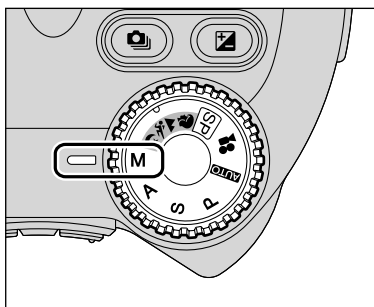

Set the Mode dial to "M".
Manual mode allows you to set any shutter speed and aperture setting.

● **Shutter speed settings**

2 sec. to 1/2000 sec. in 1/3 EV steps

● **Aperture settings**

Wide-angle : F2.8 to F8 in 1/3 EV steps

Telephoto : F3.2 to F9 in 1/3 EV steps

See P.107 for information on EVs.

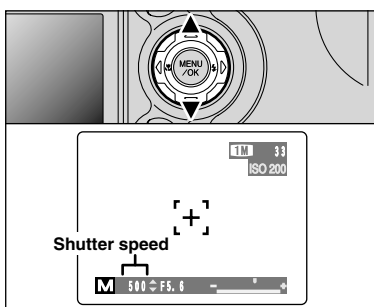

Setting the shutter speed

You can set the shutter speed by pressing the "▲" or "▼".

- In shots with long exposures, noise (dots) may appear on the image.
- When pictures are taken with a fast shutter speed (1/2000 sec.), smearing (white stripes) may appear in the image (→P.107).
- At fast shutter speeds (1/2000 sec.), the image may appear dark even if the flash is used.

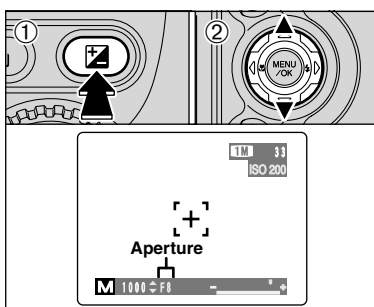

Setting the aperture

To set the aperture setting, hold down the "☑" Exposure compensation button ① and press "▲" or "▼" ②.

◆ **The exposure indicator** ◆

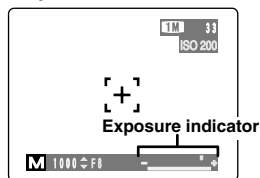

Use the exposure indicator on the screen as a guide when setting the exposure.
When the brightness of the subject is outside the camera's brightness metering range, the indicator moves to the (+) end to show that the image will be overexposed (the (+) turns yellow) or to the (-) end to show that the image will be underexposed (the (-) turns yellow).

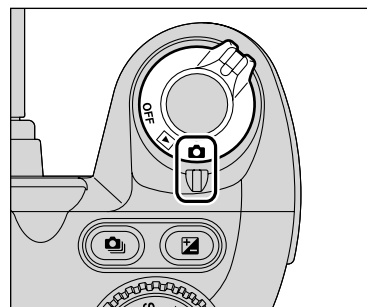

Selecting Macro mode allows you to take close-up shots.

Set the Power switch to "CAMERA".

● **Focal range**

Wide-angle : Approx. 0.1 m to 2.0 m
(0.3 ft. to 6.6 ft.)

Telephoto : Approx. 0.9 m to 2.0 m
(3.0 ft. to 6.6 ft.)

● **Effective flash range**

Approx. 0.3 m to 2.0 m (1.0 ft. to 6.6 ft.)

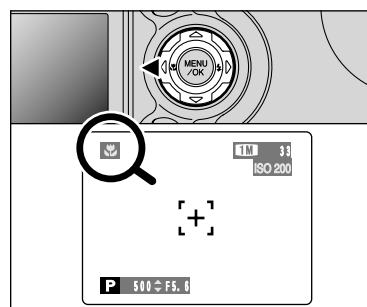

Press the "☞" (Macro button). The "☞" appears on the screen indicating that you can take close-up shots.
To cancel Macro mode, press the "☞" (Macro button) again.

- Macro photography is automatically cancelled in the following situations :
 - When the Mode dial is switched to "SP" or "SP"
 - When the camera is switched OFF
- Select the appropriate Flash mode for the conditions.
- If you are shooting in a dark location (when the "!" camera shake warning icon is displayed), use a tripod to prevent camera shake.

◆ **When you are using the flash** ◆

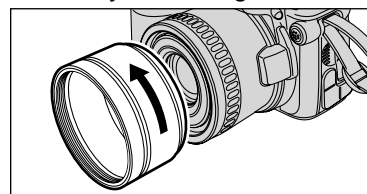

When you use the flash in Macro mode, remove the lens adapter ring.
If the adapter ring is not removed, a shadow may appear in the bottom center of your shot.

FLASH



You can choose from 5 Flash modes according to the type of shot.

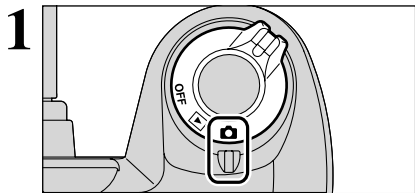

Set the Power switch to "CAM".

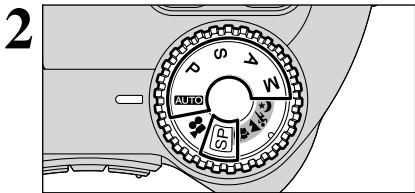

Set the Mode dial to Still photography mode.

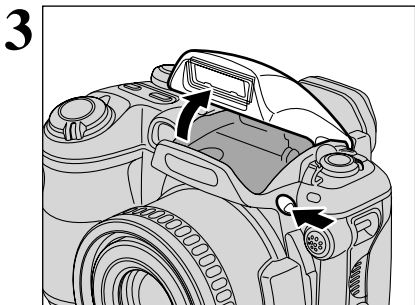

Press the Flash pop-up button to pop-up the flash.

● **Effective flash range (AUTO)**

- Wide-angle : Approx. 0.3 m to 6.0 m
(1.0 ft. to 19.7 ft.)
- Telephoto : Approx. 0.8 m to 5.5 m
(2.6 ft. to 18.0 ft.)

- ⚠ If the shutter speed is set to a speed faster than 1/1000 sec., the image may appear dark even if the flash is used.
- ⚠ When the flash is popped up or you are using the flash to take pictures, you may see the image disappear and the monitor go dark as the flash charges. The indicator lamp blinks orange while the flash is charging.

◆ **Suppressed flash** ◆

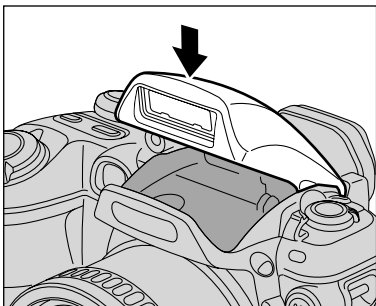

Pressing the flash down switches the camera to Suppressed flash mode.

Use this mode for photography using indoor lighting, for shots taken through glass, and for photography in venues such as theaters or at indoor sporting events where the distance is too great for the flash to be effective. When you use Suppressed flash, the Automatic white balance function (⇒P.107) operates so that natural colors are captured along with the ambience of the available light.

- ⚠ If you are shooting in Suppressed flash mode in dark conditions, use a tripod to prevent camera shake.
- ⚠ See P.23, 101 for information on the camera shake warning.

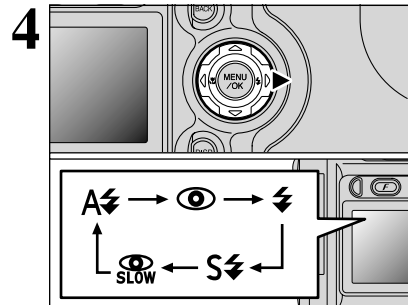

Press the "Flash" (Lightning Bolt) button to select the appropriate Flash mode.

- ⚠ If you use the flash in very dusty conditions or when it is snowing, white dots may appear in the image due to the flash reflecting off the dust particles or snowflakes. Try taking the shot using Suppressed flash mode.

The available Flash modes are limited depending on the Photography mode selected (⇒P.37).



Auto flash mode

Use this mode for ordinary photography. The flash fires automatically as required by the shooting conditions.

- ⚠ If you press the Shutter button while the flash is charging, the shot will be taken without the flash.



Red-eye reduction

Use this mode to ensure that the subject's eyes appear natural when photographing people in low-light conditions. The flash fires a pre-flash just before the picture is taken and then fires again to take the actual picture. The flash fires automatically as required by the shooting conditions.

- ⚠ If you press the Shutter button while the flash is charging, the shot will be taken without the flash.

◆ **Red-eye effect** ◆

When you use the flash to photograph people in low-light conditions, their eyes sometimes appear red in the picture. This is caused by the light of the flash reflecting off the inside of the eye. Use Red-eye reduction flash to effectively minimize the likelihood of the red-eye effect.

Take the following measures to make Red-eye reduction more effective :

- Get the subjects to look at the camera.
- Get as close as possible to the subjects.



Forced flash

Use this mode to photograph backlit scenes, such as a subject against a window or in the shade of a tree, or to obtain the correct colors when you are shooting under lighting such as fluorescent tubes. In this mode, the flash fires in bright as well as dark conditions.



⚡ Slow synchro

This is a Flash mode that uses a slow shutter speed. This allows you to take pictures of people at night that clearly show both your subjects and the night time backdrop. To prevent camera shake, always use a tripod.

- **Slowest shutter speed**
“C” (SP night scene) : Up to 2 sec.

📷 Red-eye reduction + Slow synchro

Use this mode for slow synchro shots with red-eye reduction.

- ⚠ The image may be overexposed when you shoot bright scenes.

To take a picture of a main subject at night with the background brightly lit, please use the “SP” mode “C” (Night scene) settings (➡P.38).

◆ Increasing the monitor brightness ◆

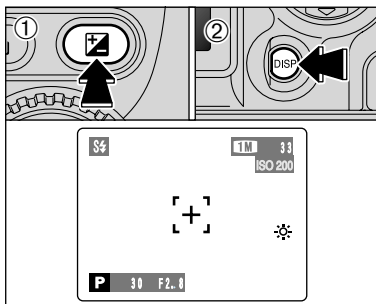

This is useful when you are checking the shot composition for dimly lit scenes (Slow synchro shots, etc.). Press the “DISP” button ② while holding down the “” Exposure compensation button ①. “” appears on the screen and the subject is displayed brightly.

To cancel increased brightness, press the “DISP” button ② again while holding down the “” button ①.

- ⚠ This function is automatically cancelled after each shot.
- ⚠ This function is purely for checking the composition of your shot. It does not increase the brightness of the photographed image.
- ⚠ In shots taken in the dark, increasing the brightness setting does not allow you to see the subject properly.

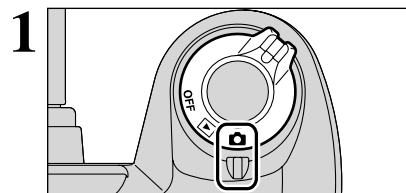

Set the Power switch to “”.

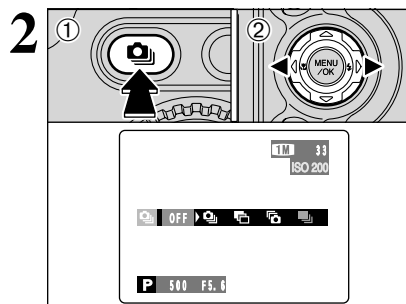

To select the Continuous shooting mode you want to use, hold down the “” Continuous shooting button ① and press “” or “” ②. Releasing the “” button confirms your selection.

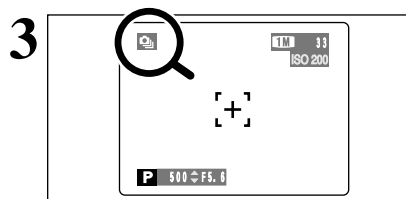

When you set the Continuous shooting mode (except for “OFF”), the selected mode appears on the screen.

- : Top 5-frame continuous shooting
- : Auto bracketing
- : Final 5-frame continuous shooting
- : Long-period continuous shooting with 1280 × 960-pixel mode

◆ Notes on using the Continuous shooting modes ◆

- Shooting continues for as long as you hold down the Shutter button. In Auto bracketing mode however, just press the Shutter button once to shoot 3 frames.
- If there is insufficient space on the **xD-Picture Card**, as many frames are shot as can be recorded on the available space. For auto bracketing however, if there is insufficient space on the media to record 3 frames, no shots are taken.
- The focus is determined in the first frame and cannot be changed in mid-sequence.
- The exposure is determined in the first frame, but in Long-period continuous shooting with 1280 × 960-pixel mode the exposure is automatically adjusted for the scene being shot.
- The speed of continuous shooting varies depending on the shutter speed.
- The speed of continuous shooting does not change with the number of recorded pixels.
- The flash cannot be used as the Flash mode is set to Suppressed flash.
- For continuous shooting, final 5-frame continuous shooting and shots taken using auto bracketing, the results are always displayed after you shoot. To choose whether or not to record the images, set “IMAGE DISP.” in SET-UP to “ON” (➡P.74). Note that shots taken using Long-period continuous shooting are recorded regardless of the setting in SET-UP.

Top 5-frame continuous shooting



In this mode, you can shoot up to 5 frames at intervals as short as 0.2 seconds. When you take the shots, the photographed images are displayed (in sequence from the left) and automatically recorded.

The maximum file recording time is 4.2 seconds (for 5-frame continuous shooting).

Auto bracketing

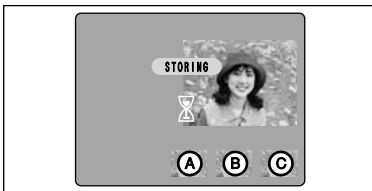

This mode automatically shoots 3 continuous frames that bracket the selected setting so that one image is correctly exposed (A), one is overexposed (B) and one is underexposed (C). The settings (exposure range) can be changed in the photography menu.

Auto bracketing settings (3)
±1/3 EV, ±2/3 EV, ±1 EV

- If the underexposed or overexposed frame is outside the camera's control range, the shot is not taken with the specified setting increments.
- Auto bracketing cannot be used in "AUTO" or "SP" mode.

Changing the setting (exposure range)

Press the "MENU/OK" button to display the menu and change the setting in the "BRACKETING" menu option (P.57).

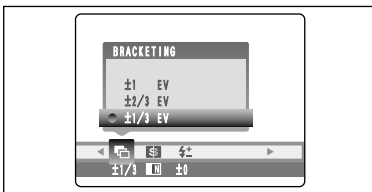

Final 5-frame continuous shooting

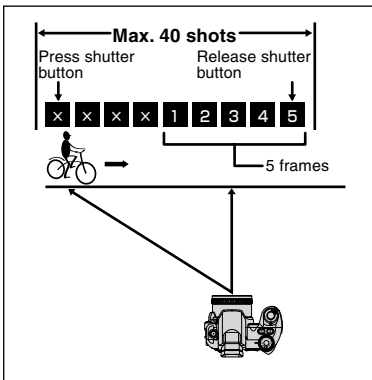

This mode allows you to release the shutter up to 40 times (at intervals as short as 0.2 seconds) and record the last 5 frames. If you take your finger off the Shutter button before 40 shots have been taken, the camera records the final 5 frames shot before you released the Shutter button.

If there is insufficient space on the media, the camera records as many of the shots taken just before the Shutter button was released as will fit on the xD-Picture Card.

Long-period continuous shooting with 1280 × 960-pixel mode

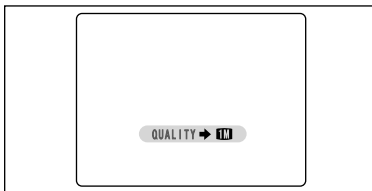

This mode allows you to take up to 40 continuous shots (at intervals as short as 0.6 seconds). In Long-period continuous shooting with 1280 × 960-pixel mode, the number of recorded pixels is automatically set to "1280x960" (1280 × 960 pixels).

Long-period continuous shooting with 1280 × 960-pixel mode cannot be used in the "SP, P, S, A" or "M" modes.

Focusing on a moving subject

If you press the Shutter button down halfway to focus on the subject at the starting point (A), the subject may no longer be in focus when it reaches point (B) where you want to take the shot. In such situations, first focus on point (B) to be photographed and then lock the focus so that it does not change when the picture is taken (lock pin). The lock pin feature is also useful for photographing fast-moving subjects that are difficult to focus on.

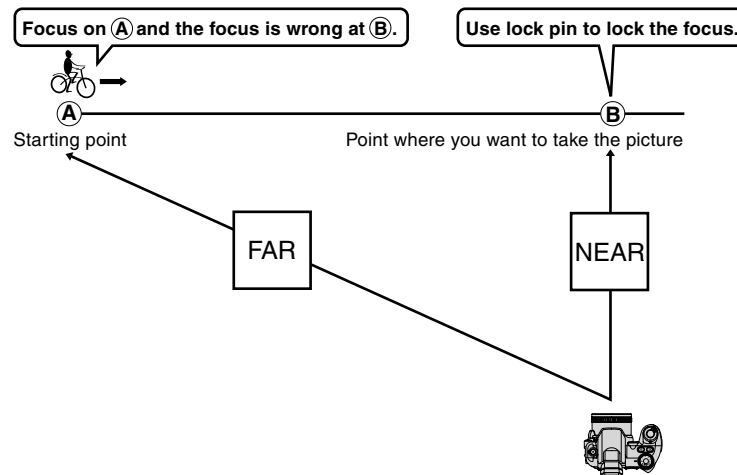

Quality and flash

When a Continuous shooting mode is selected, the flash mode is forcibly set to "Ⓢ" Suppressed flash. In a Long-period continuous shooting with 1280 × 960-pixel mode, the quality is also forcibly set to "1280x960". However, when the mode is changed back to normal photography, the flash setting specified before continuous shooting was selected is restored. Likewise, when a Long-period continuous shooting with 1280 × 960-pixel mode has been used, the quality setting is also restored to its previous value.

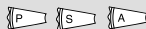

Use this function for shots where you cannot obtain the optimum brightness (exposure), such as shots with extremely high contrast between the subject and the background.

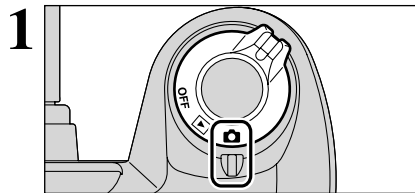

1 Set the Power switch to "ON".

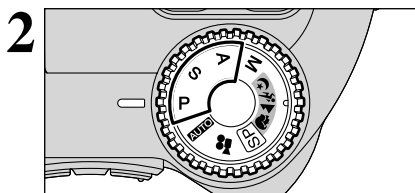

2 Set the Mode dial to "P", "S" or "A" mode.

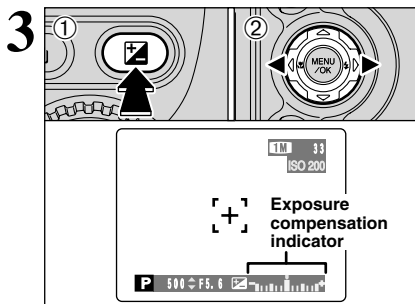

3 Hold down the "⊞" Exposure compensation button ① and press "◀" or "▶" ② to set the compensation value. The symbol indicating the compensation direction ("−" or "+") turns yellow. The "⊞" symbol also turns yellow while exposure compensation is being set and then turns blue after setting is completed.

● Compensation range

−2 EV to +2 EV (13 steps in 1/3 EV increments)

⚠ Exposure compensation cannot be used in the "AUTO", "SP" or "M" modes.

⚠ Exposure compensation is disabled in the following situations:
When "⚡" (Forced flash) or "👁" (Red-eye reduction) mode is used and the scene photographed is dark.

This setting is retained when the mode is switched or the camera is switched off (the "⊞" is displayed). Set the exposure compensation to "0" unless compensation is required.

◆ Getting the correct brightness ◆

To obtain the optimal image brightness, adjust the amount of exposure correction according to the brightness or darkness of the photographed image.

- When the subject is too light
Try using a − (negative) correction setting.
The picture is taken so that the entire image is darker.
- When the subject is too dark
Try using a + (positive) correction setting.
The picture is taken so that the entire image is brighter.
- Exposure indicator moved towards
 - Backlit portraits : +0.6 EV to +1.5 EV
 - Very bright scenes (such as snowfields) and highly reflective subjects : +0.9 EV
 - Shots made up predominantly of sky : +0.9 EV
 - Spotlit subjects, particularly against dark backgrounds : −0.6 EV
 - Scenes with low reflectivity, such as shots of pine trees or dark foliage : −0.6 EV



Use this button when you are shooting pictures of a moving subject. Using Continuous AF mode reduces the time required for focusing.

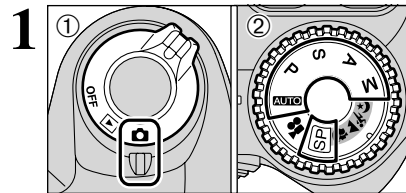

1 ① Set the Power switch to "ON".
② Set the Mode dial to Still photography mode.

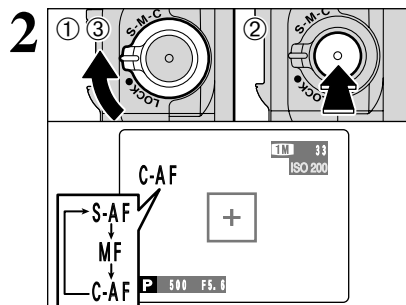

2 ① Unlock the Focus mode selector lock switch.
② Press the Focus mode selector button to set the Focus mode to "C-AF".
③ Lock the Focus mode selector lock switch to prevent inadvertent mode changes.

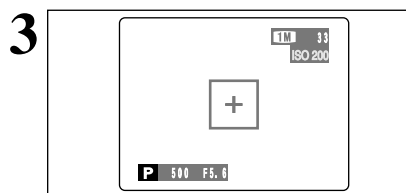

3 Frame the shot so that the subject fills the entire AF frame. The camera continues to focus on the main subject in the AF frame.

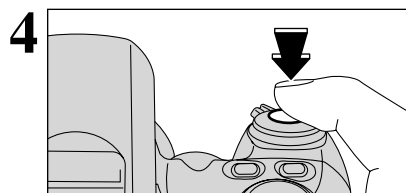

4 Press the Shutter button down halfway (AF/AE lock) and then, without releasing the button, press the button down fully to take the shot. This allows you to shorten the focusing time.

⚠ The AF mode is forcibly reset to AF (CENTER).

◆ Notes on Continuous AF ◆

Because the camera focuses continually even when the Shutter button is not pressed, note the following :

- Watch the battery level carefully since the camera consumes more power in this mode than in other Focus modes (S-AF and MF).
- If the Power save feature is set to "OFF", particular attention must be given to the battery level.

SETTING THE MANUAL FOCUS



To set the focus manually, use this function after adjusting the focus automatically with "S-AF" auto focus mode.

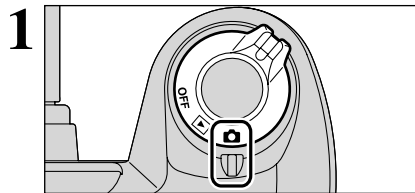

1 Set the Power switch to "ON".

- ⚠ Manual focus cannot be used in the "MOVIE" Movie mode.
- ⚠ Because the shot may go out of focus if the camera is moved, a tripod should be used.

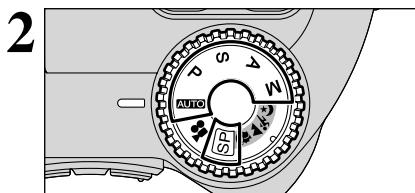

2 Set the Mode dial to Still photography mode.

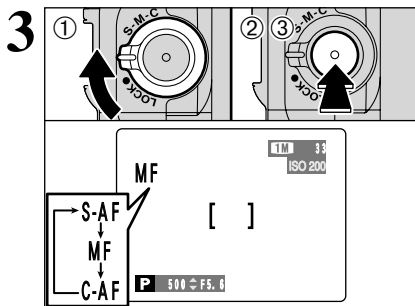

- ① Unlock the Focus mode selector lock switch.
- ② Press the focus mode selector button to set the focus mode to "S-AF", focus on the subject and press the shutter button half way. The camera is then focused on the subject.
- ③ Press the Focus mode selector button to set the Focus mode to "MF". The focusing position is locked on the subject. This is the locating pin status (→P.49).

⚠ If the subject moves or the zoom setting is changed, repeat the procedure from step ②.

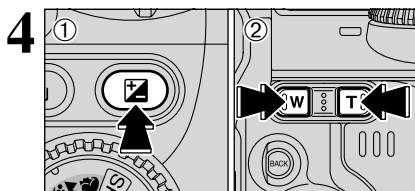

4 You can set the focus manually by holding down the "MF" button ① and pressing "T" or "W" ② while viewing the image on the screen.

PHOTOGRAPHY MENU OPERATION

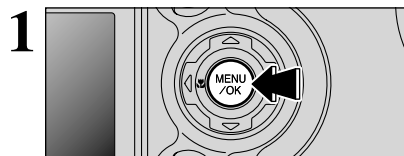

1 Press the "MENU/OK" button to display the menu.



- ① Press "◀" or "▶" to select the menu item and "▲" or "▼" to change the setting.
- ② Press the "MENU/OK" button to confirm the selection.

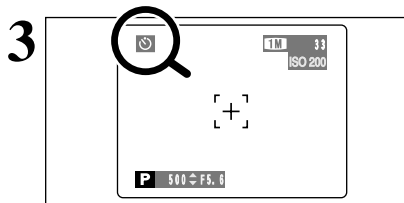
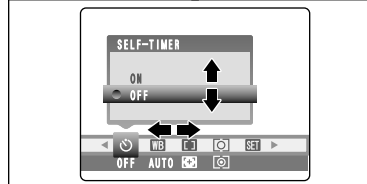

3 When you enable the setting, an icon appears in the top-left corner of the screen.

⚠ The settings available in the menu screen vary depending on the Still photography mode.

⌚ SELF-TIMER PHOTOGRAPHY → P.54

The self-timer is used for taking pictures such as group shots where the photographer is included in the shot.

📷 BRACKETING → P.57

Use this feature to photograph the same image with different exposure settings.

[] AF MODE → P.55

This sets the focusing method.

📏 SHARPNESS → P.57

Use this setting to soften or emphasize outlines or to adjust the quality of the photographed image.

WB SETTING THE WHITE BALANCE → P.56

Change the white balance setting to take a picture with the white balance fixed for the surroundings and lighting when the picture is taken.

⚡ FLASH BRIGHTNESS ADJUSTMENT → P.57

Change this setting to adjust the amount of light emitted by the flash to suit the photography conditions or to achieve a desired effect.

[O] PHOTOMETRY → P.56

Change this setting for scenes where the brightness of the subject and background differ markedly so that the MULTI setting does not give the desired photometry results.

SELF-TIMER PHOTOGRAPHY

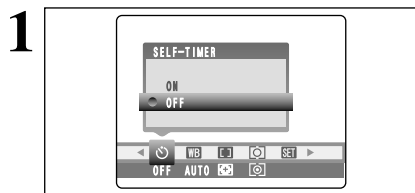

The self-timer is used in situations such as group shots where the photographer is included in the shot. When you set the self-timer to ON, “⌚” appears on the screen.

⌚ : The shot is taken after 10 seconds.

- The self-timer function is automatically cancelled in the following situations.
 - When shooting ends
 - When the Mode dial is moved to another setting
 - When the camera is switched to Playback mode
 - When the camera is switched off



- Press the Shutter button down halfway to focus on the subject.
- Without releasing the Shutter button, press the button all the way down (fully pressed) to start the self-timer.

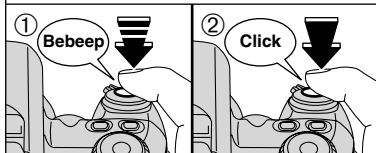

- You can also use the AF/AE lock (→P.24).
- Take care not to stand in front of the lens when you press the Shutter button as this can prevent the correct focus or brightness (exposure) being obtained.

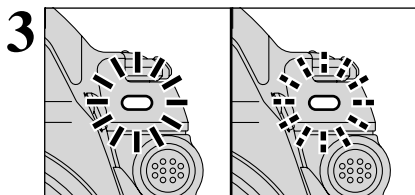

The self-timer lamp lights and then starts flashing until the picture is taken.

- To stop the self-timer, once it has started running, press the “BACK” button.

Self-timer lamp display

⌚ Lit for 5 seconds → Blinking for 5 seconds.

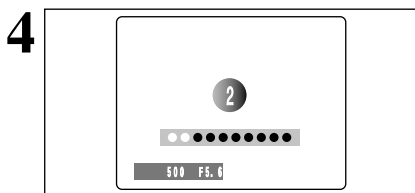

A countdown is displayed on the screen indicating the time remaining until the picture is taken. Self-timer mode is automatically cancelled after each shot.

[] AF MODE

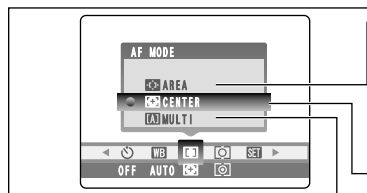

AREA

You can change the position on the screen where the camera focuses. Use this feature when you have composed your shot using a tripod and then want to change the focusing position.

CENTER

The camera focuses on the center of the screen.

MULTI

When the Shutter button is pressed down halfway, the camera automatically recognizes a strongly contrasting subject at or close to the center of the screen and displays the AF frame on the subject in focus.

- If the camera has difficulty identifying the main subject, set the Focus mode to “CENTER” and use AF/AE lock (→P.24).

The AF mode can only be selected when the focus mode is S-AF (→P.20).

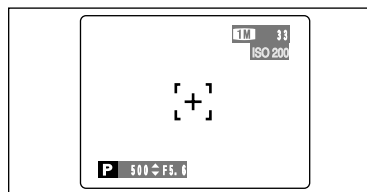

CENTER

The camera focuses on the center of the screen. This is a useful feature when used for shots using AF/AE lock (→P.24).

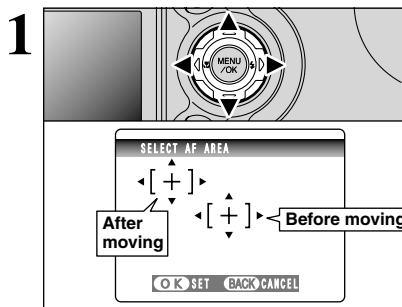

AREA

Press “▲”, “▼”, “◀”, or “▶” to move the “+” mark (target point) to the desired focusing position.

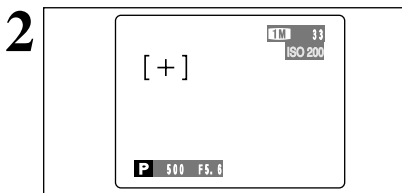

The AF frame is displayed in the location to which the target point was moved. Take the photograph as usual. To reposition the AF frame, select “AREA” from the “[]” AF MODE menu.

Regardless of the AF frame location, the exposure is always set using the area in the center of the screen.

WB SETTING THE WHITE BALANCE

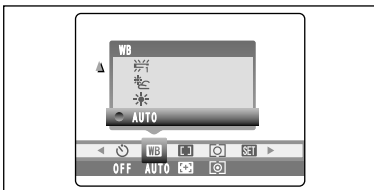

Change the white balance setting when you want to take a picture with the white balance fixed for the surroundings and lighting when the picture is taken. In AUTO mode, the correct white balance may not be obtained for subjects such as close-ups of people's faces and shots taken under a special light source. In such situations, select the correct white balance for the light source. See P.107 for more information on the white balance.

- AUTO**: Automatic adjustment
(Shooting to show the ambience of the light source)
- : Shooting outdoors in fine weather
 - : Shooting in shade

- : Shooting under "Daylight" fluorescent lamps
- : Shooting under "Warm White" fluorescent lamps
- : Shooting under "Cool White" fluorescent lamps
- : Shooting in incandescent light

* Because white balance settings (other than custom white balance settings) are ignored when you use the flash, you should select Suppressed flash mode (→P.44) to achieve the intended shot.

The color tones may vary somewhat depending on the shooting conditions (light source, etc.).

[O] PHOTOMETRY

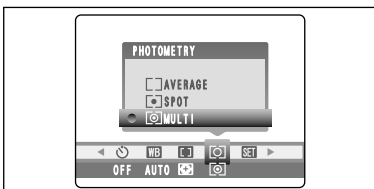

Use this mode for scenes where the brightness of the subject and background differ markedly so that the MULTI setting is unlikely to achieve the desired result.

- [] **AVERAGE**: Light metering where an average value for the entire image is used.
- [•] **SPOT**: Light metering where the exposure is optimized for the center of the image (approx. 6.25%).
- [O] **MULTI**: Light metering where the camera automatically assesses the scene and selects the optimum exposure.

In the "AUTO", "SP" and "•" modes, light metering is fixed at the "MULTI" setting and cannot be changed.

◆ The light metering modes are effective for the following subjects ◆

- **AVERAGE**
The advantage of this mode is that the exposure tends not to change for different compositions or subjects. This mode is particularly effective for shots of people wearing black or white clothing and shots of scenery.
- **SPOT**
This mode is useful for subjects with strongly contrasting light and dark areas where you want to achieve the correct exposure for a particular feature.
- **MULTI**
In this mode, the camera uses automatic scene recognition to analyze the subject and provide optimum exposure in a wide range of shooting conditions. This mode should be used for everyday photography.

BRACKETING

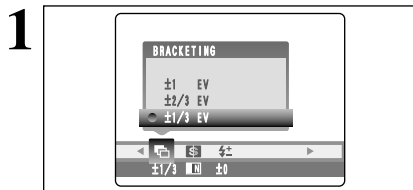

Use this feature to photograph the same image with different exposure settings. Auto bracketing automatically shoots 3 consecutive frames, one of which is correctly exposed while the remaining two are underexposed and overexposed respectively by a set amount.

● The three available settings are ±1/3 EV, ±2/3 EV and ±1 EV. See P.107 for more information on EVs.

- If the underexposed or overexposed frame is outside the camera's control range, the shot is not taken with the specified setting increments.
- Flash photography cannot be used.
- This feature always takes 3 shots. However, if there is insufficient space on the xD-Picture Card for 3 shots, no picture will be taken.

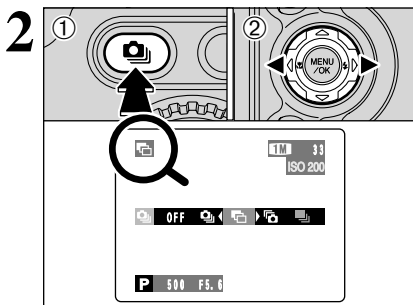

After setting the exposure for bracketing, hold down the "BKT" button ① and press "◀" or "▶" ② to select "BKT".

SHARPNESS

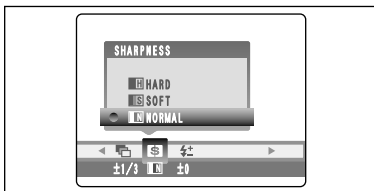

Use this setting to soften or emphasize outlines or to adjust the image quality.

- HARD**: Emphasizes the outlines. Best for shots of subjects such as buildings or text where you want sharp images.
- SOFT**: Softens the outlines. Best for shots of subjects such as people, where a softer image is desirable.
- NORMAL**: Best for ordinary photography. Provides edge sharpness that is ideal for ordinary shots.

FLASH BRIGHTNESS ADJUSTMENT

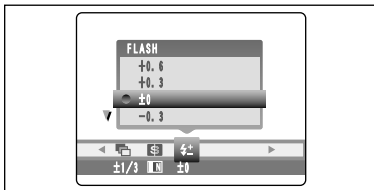



Brightness adjustment allows you to change just the amount of light emitted by the flash to suit the photography conditions or to achieve a desired effect.

● **Adjustment range**: ±2 steps
-0.6 EV to +0.6 EV in approx. 0.3 EV increments (total: 5 levels selectable)
See P.107 for information on EVs.

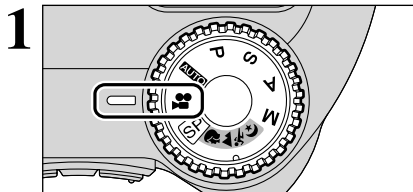
- Depending on the type of subject and the shooting distance, brightness adjustment may have no effect.
- The image may appear dark when the shutter speed is set to speeds higher than 1/1000 sec.



1 Set the Mode dial to “”.
“” Movie mode allows you to shoot movies with sound.

- **Specifications :**
Motion JPEG with monaural sound
Quality mode  : 320 × 240 pixels
- **Frame rate :** 30 frames per second

- ⚠ The available recording time for a video may decrease depending on the amount of free space on the **xD-Picture Card**.
- ⚠ Because a movie is recorded onto the **xD-Picture Card** as it is shot, it cannot be recorded correctly if the camera suddenly loses power (if you open the battery cover or disconnect the AC power adapter).

It may not be possible to playback your movies on other cameras.

■ Recording times for xD-Picture Card

* Available recording times are for **xD-Picture Card** formatted in the camera.

	Quality mode  (30 frames per second)
DPC-16 (16 MB)	26 sec.
DPC-32 (32 MB)	54 sec.
DPC-64 (64 MB)	109 sec.
DPC-128 (128 MB)	219 sec.
DPC-256 (256 MB)	7.3 min.
DPC-512 (512 MB)	14.6 min.

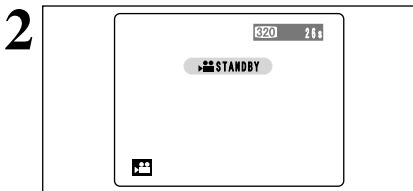

2 The available recording time and “ STANDBY” are displayed on the screen.

- ⚠ Because sound is recorded concurrently with the images, ensure that you do not cover the microphone with a finger, etc. (→P.9).

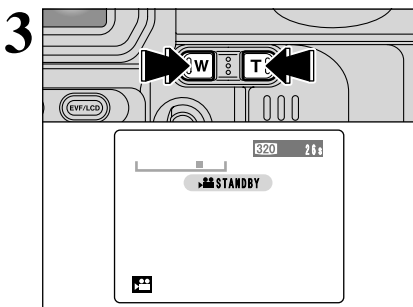

3 Press the “**T**” or “**W**” button to zoom in or out before shooting is started. You must zoom beforehand as you cannot zoom during shooting.

- **Optical zoom focal length**
(35 mm camera equivalent)
Approx. 37 mm to 370 mm
Max. zoom scale : 10×
- **Focal range**
Wide-angle : Approx. 0.9 m (3.0 ft.) to infinity
Telephoto : Approx. 2.0 m (6.6 ft.) to infinity

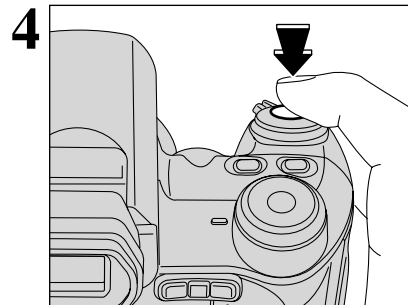

4 Press the Shutter button down fully to start shooting.

- ⚠ The brightness and color of the screen shown during movie shooting may differ from those shown before shooting begins.
- ⚠ You do not need to hold down the Shutter button.

Pressing the Shutter button down fully locks the focus, but the exposure and white balance vary automatically according to the scene being shot.

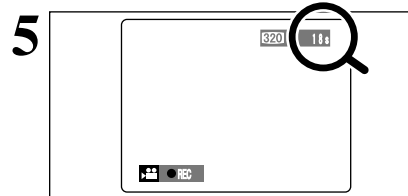

5 A counter displayed in the top-right corner of the screen during shooting shows the remaining time.

- ⚠ If the brightness of the subject changes while you are shooting a movie, the sound of the lens operating may be recorded in the movie.
- ⚠ Some wind noise may be recorded in shots taken outdoors.
- ⚠ When the remaining time runs out, shooting automatically ends and the movie is recorded onto the **xD-Picture Card**.

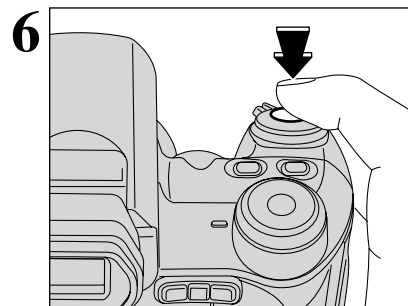

6 Pressing the Shutter button during shooting ends movie shooting and the movie is recorded onto the **xD-Picture Card**.

- ⚠ If shooting is stopped immediately after it begins, only approximately 1 second of movie is recorded onto the **xD-Picture Card**.

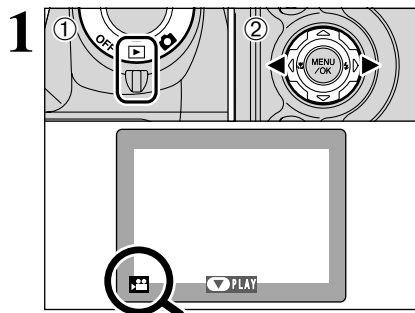

- 1 Set the Power switch to "ON".
- 2 Press "◀" or "▶" to select the movie file.

Movies cannot be played back using multi-frame playback. Use the "DISP" button to select single-frame playback.

Indicated by the "🎬" icon.

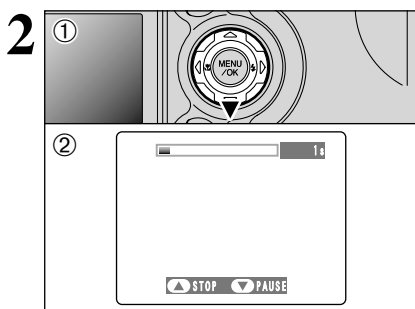

- 1 Press "▼" to play the movie.
- 2 The screen shows the playback time and a playback progress bar.

- Take care not to block the speaker.
- If the sound is difficult to hear, adjust the volume (→P.72).
- If the subject of the shot is very bright, white vertical streaks or black horizontal streaks may appear in the image during playback. This is normal and does not indicate a fault.

■ Playing back movies

	Control	Description
Playback/Pause		Playback begins. Playback automatically stops when the end of the movie is reached. During playback, this button pauses the movie.
Stop		Stops playback. * Press "◀" or "▶" while movie playback is stopped to go back to the previous file or advance to the next file respectively.
Fast forward/ Rewind	Fast forward Rewind	Press these during playback to skip forwards or backwards through the movie.
Skip playback	 When paused	Each time you press "◀" or "▶" when the movie is paused, the movie advances or goes back one frame.

◆ Playing movie files ◆

You may not be able to play some movie files recorded on other cameras.

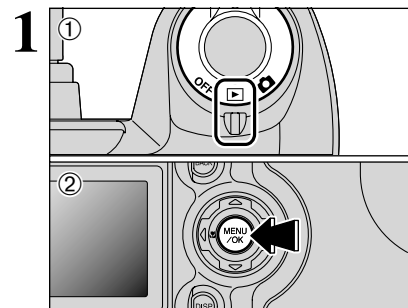

- 1 Set the Power switch to "ON".
- 2 Press the "MENU/OK" button to display the menu screen.

Note that mistakenly erased frames (files) cannot be recovered. You should back up important frames (files) that you do not want to be erased onto your computer or other media.

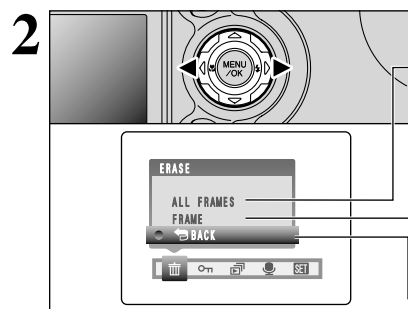

Press "◀" or "▶" to select "ERASE".

ALL FRAMES

Erases all unprotected frames (files). You should copy important frames (files) that you do not want to be erased to your computer or other media.

FRAME

Erase only the selected frame (file).

BACK

Returns to playback without erasing any frames (files).

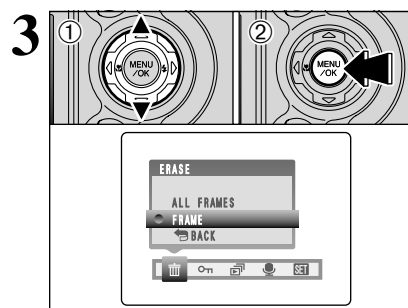

- 1 Press "▲" or "▼" to select "ALL FRAMES" or "FRAME".
- 2 Press the "MENU/OK" button.

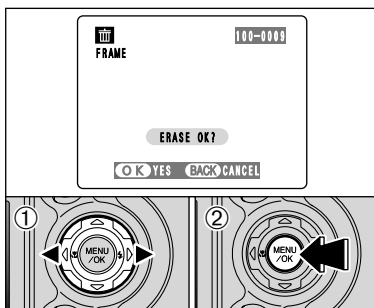

FRAME

- ① Press “◀” or “▶” to select the frame (file) to be erased.
 - ② Press the “MENU/OK” button to erase the currently displayed frame (file).
- To erase another image, repeat steps ① and ②. When you have finished erasing images, press the “BACK” button.

⚠ Protected frames (files) cannot be erased. Unprotect the frames (files) before erasing them (➡P.63).

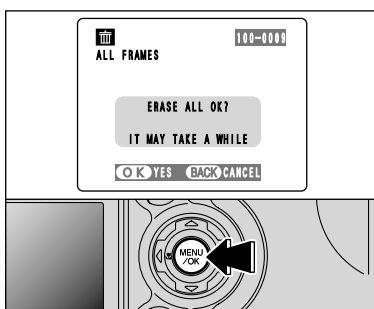

ALL FRAMES

Press the “MENU/OK” button erases all the frames (files).

- ⚠ To cancel erasing of all the frames (files) while it is still in progress, press the “BACK” button.
- ⚠ Protected frames (files) cannot be erased. Unprotect the frames (files) before erasing them (➡P.63).

If the “DPOF SPECIFIED.”, message appears, press the “MENU/OK” button again to erase the frames (files).

◆ To stop the procedure mid-way ◆

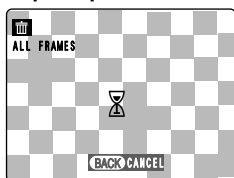

Press the “BACK” button to stop erasing all the frames (files). Some unprotected frames (files) will be left unerased.

⚠ Even if you stop the procedure immediately, some frames (files) will be erased.

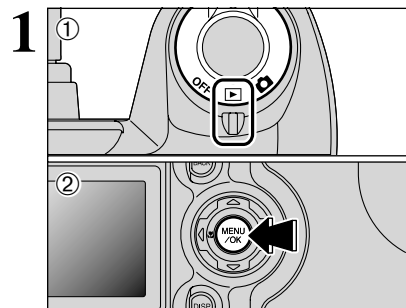

- ① Set the Power switch to “▶”.
- ② Press the “MENU/OK” button to display the menu screen.

Protection is a setting that prevents frames (files) from being accidentally erased. However, the “FORMAT” function erases all the frames (files), including protected frames (files) (➡P.75).

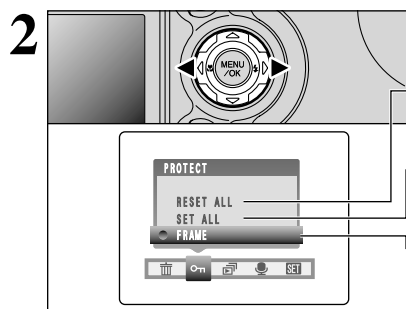

Press “◀” or “▶” to select “On” PROTECT.

RESET ALL

Removes the protection from all the frames (files).

SET ALL

Protects all the frames (files).

FRAME

Protects or unprotects only the selected frame (file).

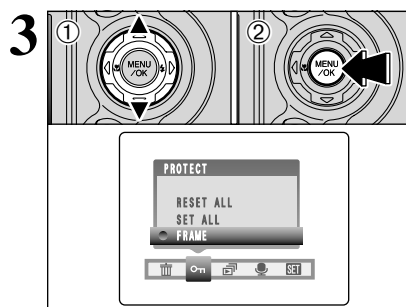

- ① Press “▲” or “▼” to select “FRAME”, “SET ALL” or “RESET ALL”.
- ② Press “MENU/OK” button to confirm your selection.

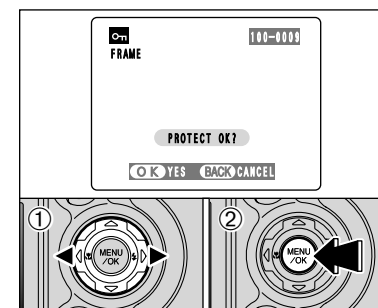

FRAME SET

- ① Press “◀” or “▶” to select the frame (file) to be protected.
- ② Press the “MENU/OK” button to protect the frame (file) currently displayed.

To protect another frame (file), repeat steps ① and ②. To finish protecting frames (files), press the “BACK” button.

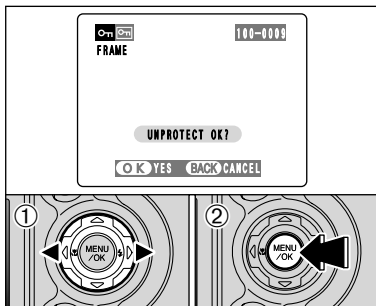

FRAME RESET

- ① Press “◀” or “▶” to select the protected frame (file).
- ② Press the “MENU/OK” button to unprotect the displayed frame (file).

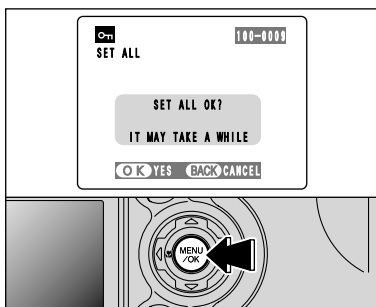

SET ALL

Press the “MENU/OK” button to protect all the frames (files).

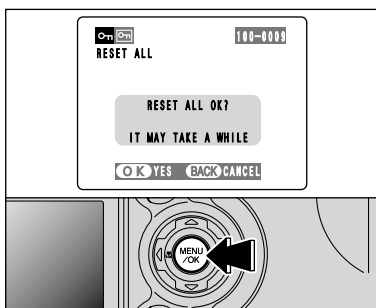

RESET ALL

Press the “MENU/OK” button to unprotect all the frames (files).

◆ **To stop the procedure mid-way** ◆



If the photographed images are very large, protecting or unprotecting all the frames (files) may take some time.
If you want to shoot a picture or a movie during the procedure, press the “BACK” button. To then return to protecting or unprotecting all the frames (files), start the procedure on P.63 from step 1.

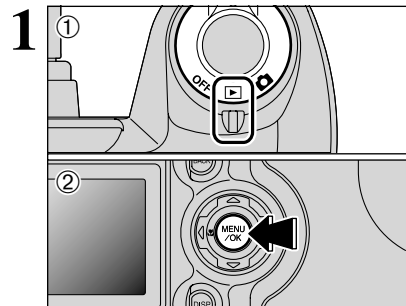

- ① Set the Power switch to “ON”.
- ② Press the “MENU/OK” button to display the menu screen.

The Power save function does not operate during playback.
 Movie starts automatically. When the preview movie or movie ends, playback moves on to the next frame.

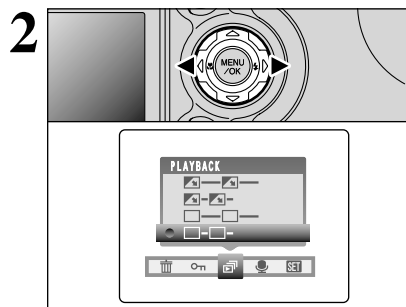

Press “◀” or “▶” to select “” PLAYBACK.

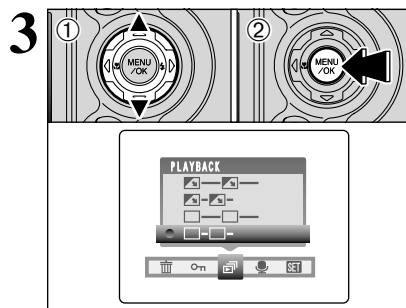

- ① Press “▲” or “▼” to select the playback interval and the type of image transition.
- ② Press the “MENU/OK” button. The image frames are automatically advanced and played back.

If you press the “DISP” button once during playback, the playback frame number is displayed on the screen.
 To interrupt “” PLAYBACK, press the “BACK” button.

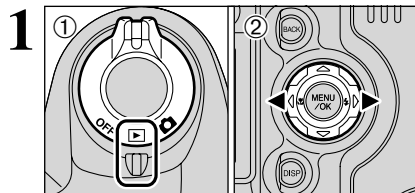



You can add voice memos to still images.

- **Recording format** : WAVE (→P.107)
PCM recording format
- **Audio file size** : Approx. 480 KB
(for a 30 second voice memo)

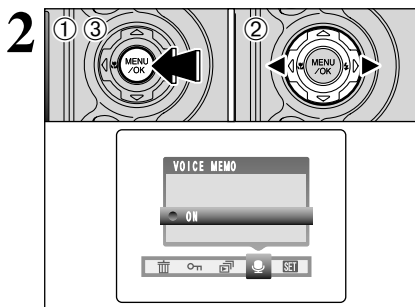
- ① Set the Power switch to “ON”.
- ② Press “◀” or “▶” to select the image (still image) to which you want to add a voice memo.



- ① Press the “MENU/OK” button to display the menu screen.
- ② Press “◀” or “▶” to select “” VOICE MEMO.
- ③ Press the “MENU/OK” button.

 If the “PROTECTED FRAME” message appears, unprotect the frame.

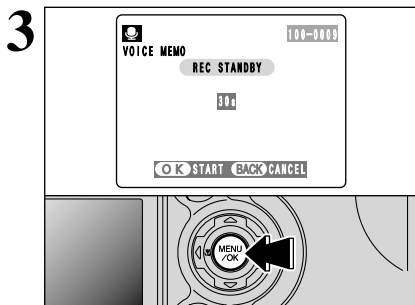

“REC STANDBY” appears on the screen.
Press the “MENU/OK” button to begin recording.

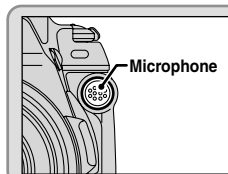

Face the microphone (→P.9) on the front of the camera to record your comment. Hold the camera roughly 20 cm (7.9 in.) away for the best results.

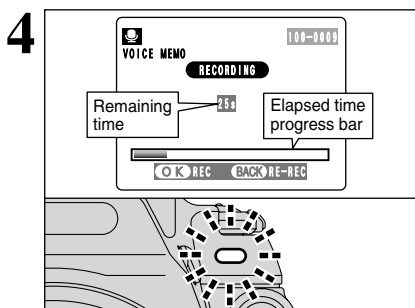

The remaining recording time is displayed during recording and the self-timer lamp blinks.
When the time remaining reaches 5 seconds, the self-timer lamp starts blinking quickly.

 To end your comment during recording, press the “MENU/OK” button.

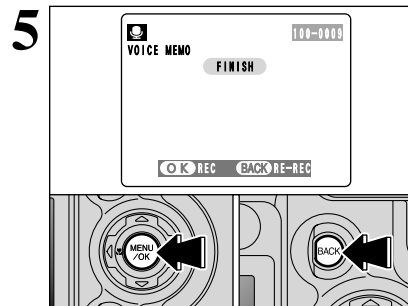

After 30 seconds of recording, “FINISH” appears on the screen.

To finish : Press the “MENU/OK” button.
To re-record your comment : Press the “BACK” button.

◆ **When the image already has a voice memo** ◆

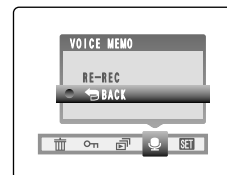

If you select an image that already has a voice memo, a screen appears in which you can select whether or not to rerecord the memo.

 If the “PROTECTED FRAME” message appears, unprotect the frame.

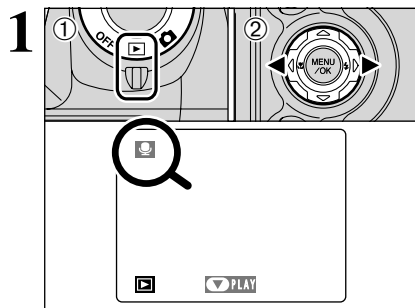

- 1 Set the Power switch to "▶".
- 2 Press "◀" or "▶" to select an image file that has a voice memo.

⚠ You cannot playback voice memos using multi-frame playback. Use the "DISP" button to select single-frame playback.

Indicated by the "🗣️" icon.

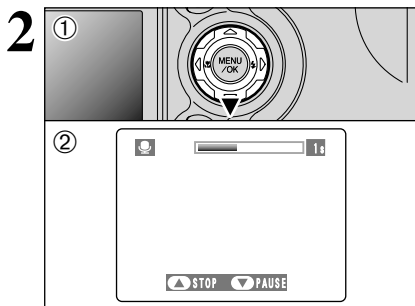

- 1 Press "▶" to play the voice memo.
- 2 The playback time is displayed on the screen along with a progress bar.

⚠ If the sound is difficult to hear, adjust the volume (⇒P.72).

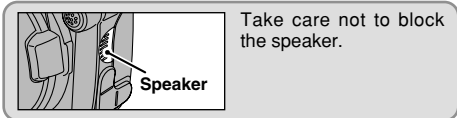

■ Playing back voice memos

	Control	Description
Playback		The voice memo automatically stops when playback ends.
Pause/Resume		Pauses the voice memo during playback. Press this button again to resume playback.
Stop		Stops playback. * Press "◀" or "▶" while voice memo playback is stopped to go back to the previous file or advance to the next file respectively.
Fast forward/Rewind		Press these during playback to skip forwards or backwards through the voice memo. * These buttons do not function while playback is paused.

◆ Compatible voice memo files ◆

You can use your FinePix S5000 to playback voice memos recorded on this camera or voice memos up to 30 seconds long recorded onto an **xD-Picture Card** using a FUJIFILM digital camera.



DPOF stands for Digital Print Order Format and refers to a format that is used for recording printing specifications for images shot using a digital camera on media such as an **xD-Picture Card**. The recorded specifications include information on which frames are to be printed.

This section gives a detailed description of how to order your prints with the FinePix S5000.

On the FinePix S5000, you can specify only one print per image in the DPOF settings.

* Note that some printers do not support date and time imprinting or specification of the number of prints.

* Note that the warnings shown below may be displayed while you are specifying the prints.

DPOF SPECIFIED. ERASE OK? ()

ERASE ALL OK? (⇒P.62)

When you erase the image, the DPOF setting for that image is deleted at the same time.

RESET DPOF OK? (⇒P.70)

If you load an **xD-Picture Card** that contains frames specified for printing on another camera, those print specifications are all reset and replaced by the new print specifications.

DPOF FILE ERROR (⇒P.102)

Up to 999 frames can be specified on the same **xD-Picture Card**.

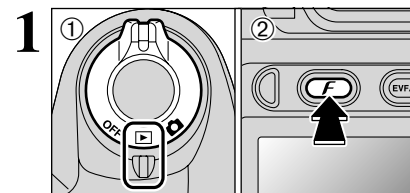

- 1 Set the Power switch to "▶".
- 2 Press the Photo mode "F" button.



Press "◀" or "▶" to select "🗣️" DPOF.

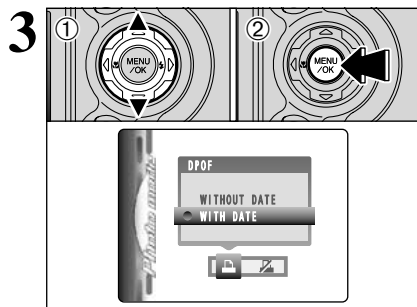

- ① Press “▲” or “▼” to select “WITH DATE” or “WITHOUT DATE”. If you select “WITH DATE”, the date is imprinted on your prints.
- ② Press the “MENU/OK” button.

◆ **When DPOF settings were specified on another camera** ◆



When the data includes a frame (file) with DPOF settings that were specified on another camera, “RESET DPOF OK?” is displayed. Pressing the “MENU/OK” button (or the Photo mode “F” button) erases all of the DPOF settings already specified for each frame (file). You must then specify the DPOF setting for each frame (file) again.

- ✔ Press the “BACK” button to leave the previous settings unchanged.

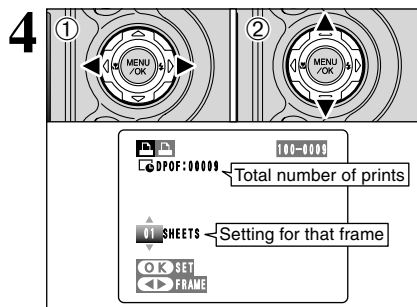

- ① Press “◀” or “▶” to select the frame (file) to be set.
 - ② Press “▲” or “▼” to set a value up to 99 as the number of copies of the frame (file) to be printed. For frames (files) that you do not want printed, set the number of prints to 0.
- To specify more DPOF settings, repeat steps ① and ②.

- ✔ You can order prints of up to 999 image frames on the same xD-Picture Card.
- ✔ You cannot specify DPOF settings for movies or CCD-RAW files.

If you press the “BACK” button during the settings, all the new settings are cancelled. If there were previous DPOF settings, only the modifications are cancelled.

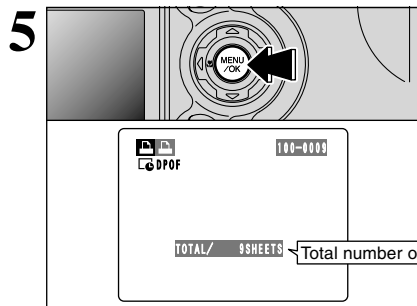

Always press the “MENU/OK” button when you complete the settings. If you press the “BACK” button, no DPOF settings are specified.

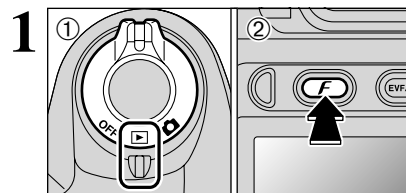

- ① Set the Power switch to “▶”.
- ② Press the Photo mode “F” button.

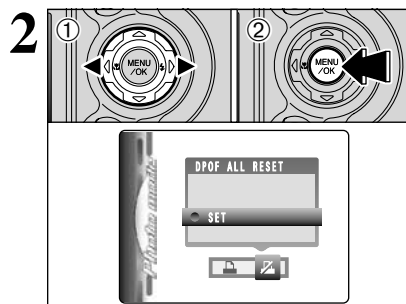

- ① Press “◀” or “▶” to select “Z” DPOF ALL RESET.
- ② Press the “MENU/OK” button.

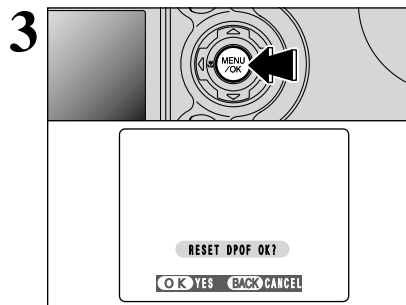

A confirmation screen appears. To reset all the DPOF settings, press the “MENU/OK” button.

ADJUSTING THE MONITOR BRIGHTNESS/ ADJUSTING THE VOLUME

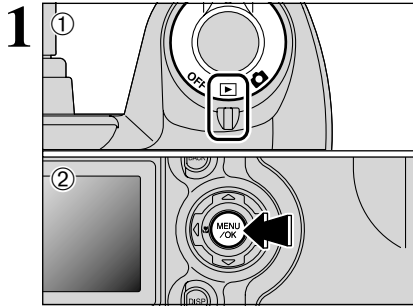

- ① Set the Power switch to "CAM" or "PC".
- ② Press the "MENU/OK" button to display the menu screen.

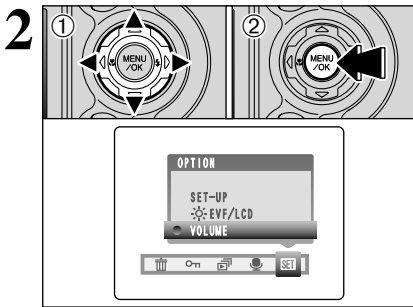

- ① Press "◀" or "▶" to select "SET" OPTION and then press "▲" or "▼" to select "EVF/LCD" or "VOLUME".
- ② Press the "MENU/OK" button.

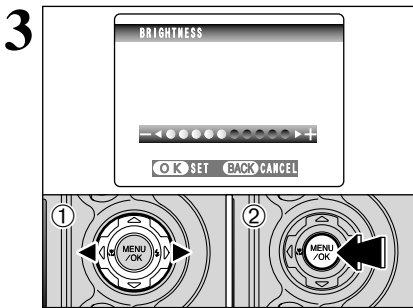

- ① Press "◀" or "▶" to adjust the monitor brightness or the volume.
- ② Press the "MENU/OK" button to confirm the new setting.

◆ SET-UP menu options ◆

The options available in the "SET" menu vary depending on whether the "CAM", "PC" or "PLAY" mode is selected.

● "CAM" Still photography mode

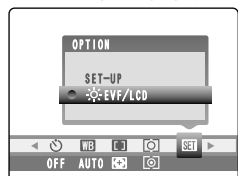

● "MOVIE" Movie mode

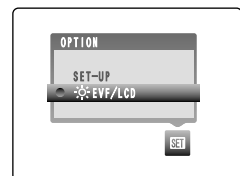

● "PLAY" Playback mode

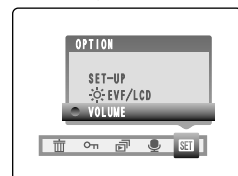

SET-UP

■ SET-UP menu options

Settings	Display	Factory default	Explanation
IMAGE DISP.	ON/OFF/PREVIEW	ON	Use this option to specify whether the preview images (the photographed image) is displayed after you take a shot. See P.74 for details.
POWER SAVE	2 MIN/5MIN/OFF	2 MIN	Use this option to specify whether the camera's power consumption is reduced and the camera is subsequently switched off automatically when it is not being used. See P.75 for details.
FORMAT	OK	-	Erases all files. See P.75 for details.
BEEP	OFF/1/2/3	2	Sets the volume of the tone emitted when the camera controls are used.
SHUTTER	OFF/1/2/3	2	Sets the volume of the sound emitted when the shutter operates.
DATE/TIME	SET	-	Use this option to correct the date or time. See P.14 for details.
FRAME NO.	CONT./RENEW	CONT.	Specifies whether frame numbers are assigned consecutively from previous numbers or begin again. See P.76 for details.
USB MODE	PC/DSC	PC	Selects whether "DSC" mode or "PC" PC Camera mode is used when the camera is connected to a computer. See P.87 for details.
CCD-RAW	OFF/ON	OFF	Sets the image quality to CCD-RAW. Because no image processing is performed on the camera for CCD-RAW images, they must be processed on a computer.
言語/LANG.	日本語/ENGLISH/ FRANCAIS/DEUTSCH/ ESPAÑOL/中文	ENGLISH	Use this setting to specify the language used for monitor display.
VIDEO SYSTEM	NTSC/PAL	-	Specifies whether video output is set to NTSC or PAL.
DISCHARGE	OK	-	Discharges rechargeable batteries. See P.99 for details.
RESET	OK	-	Resets all the camera settings (other than the DATE/TIME, LANG. and VIDEO SYSTEM) to the factory default values set at shipment. A confirmation message appears when you press "▶". To reset the camera settings, press the "MENU/OK" button again.

SET USING THE SET-UP SCREEN

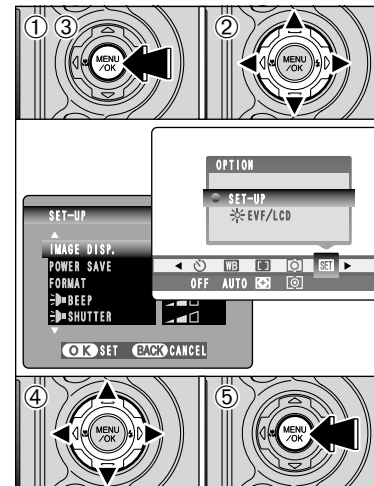

- ① Press the "MENU/OK" button to display the menu screen.
- ② Press "◀" or "▶" to select "SET" OPTION and then press "▲" or "▼" to select "SET-UP".
- ③ Press the "MENU/OK" button to display the SET-UP screen.
- ④ Press "▲" or "▼" to select a menu option and then press "◀" or "▶" to change the setting.
- ⑤ After you have modified the settings, press the "MENU/OK" button to confirm the changes.

- ⚠ Always switch the camera off when replacing the batteries. If you open the battery cover or disconnect the AC power adapter without switching the camera off, the camera settings may revert to the factory default values set at shipment.
- ⚠ Press "▶" for "FORMAT", "DATE/TIME", "DISCHARGE", "RESET".

IMAGE DISPLAY

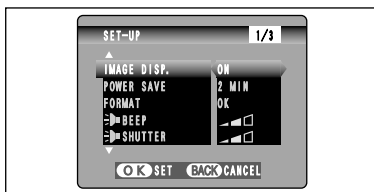

You can use this setting to specify whether photographed images are displayed after shooting.

- In Long-period continuous shooting with 1280 × 960-pixel mode, the photographed images are not displayed.
- In top5-frame continuous shooting, and final5-frame continuous shooting, the images are displayed for a set time before being automatically recorded even when "OFF" is selected here.

- ON :** Photographed images are displayed for approx. 2 seconds and then automatically recorded.
- OFF :** Photographed images are automatically recorded without being displayed.
- PREVIEW :** The results of your shot are shown as a preview (for image checking) and you can then choose whether or not to record the image.
- To record the image : Press the "MENU/OK" button.
 - To discard the image : Press the "BACK" button.
- You can also use the preview zoom

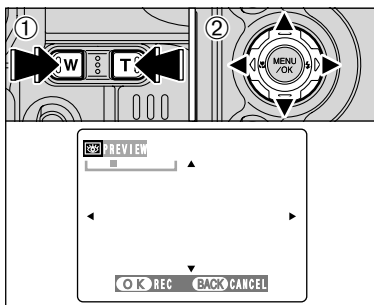

Preview zoom

When the "PREVIEW" setting is selected, this function lets you enlarge images for detailed checking.

- ① Press the "T" or "W" button to zoom in or out.
- ② Press "▲", "▼", "◀" or "▶" to view another part of the image.

- You cannot save a cropped image from the preview function.
- Preview zoom works in the same way as the playback zoom (→P.28).

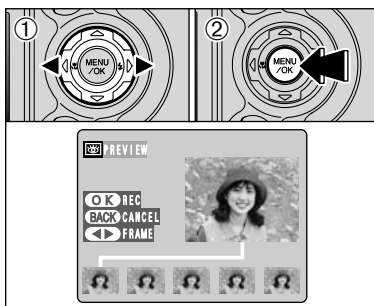

Continuous shooting preview (image checking)

When the "PREVIEW" setting is selected, you can check images shot in the "CONT." and "FINAL 5" modes.

- However, you cannot use the preview zoom.
- ① You can check the images by pressing "◀" or "▶".
 - ② Press the "MENU/OK" button to record all the images.

- If the "BACK" button is pressed, none of the images are recorded.

POWER SAVE SETTING (low power setting)

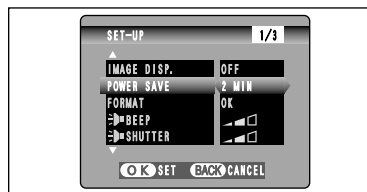

When this function is enabled, the screen temporarily switches off (the indicator lamp (green) flashes at 1-second intervals) to save power if the camera is not used for approx. 30 seconds. If the camera remains unused for an additional interval (2 minutes or 5 minutes), it is automatically switched off. Use this function when you want to get the maximum possible running time from your battery.

- The Power save function is disabled during Auto play and when a USB connection is being used.

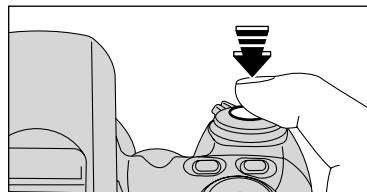

Pressing the Shutter button down halfway while the indicator lamp (green) is blinking once a second restores the camera to the fully active status (ready to shoot). This is useful since the camera can be ready to take pictures almost instantly.

- You can wake the camera up by pressing any other button as well as the Shutter button.

In Setup and Playback modes, the function that automatically switches off the LCD monitor is disabled. However, the camera still switches off automatically if it is left unused for a set time (2 minutes or 5 minutes).

To restore power to the camera

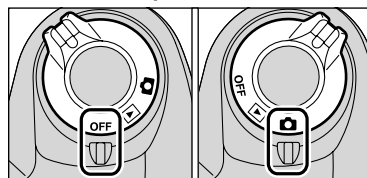

When the Power save function has switched the camera off, set the Power switch to OFF briefly and then back to ON to switch the camera back on so that it is ready to use.

FORMAT

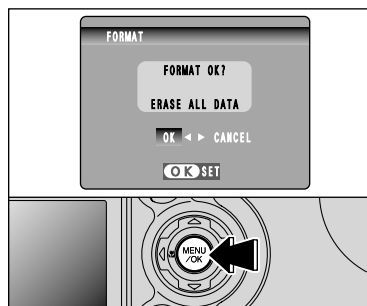

Formatting erases protected files also. Formatting erases all the files. Initialize the **xD-Picture Card** for use in the camera. You should copy important files that you do not want to be erased to your computer or other media.

- ① Press "◀" or "▶" to select "OK".
- ② Pressing the "MENU/OK" button erases all the files and initializes the **xD-Picture Card**.

- If the "[CARD ERROR]" "[WRITE ERROR]" "[READ ERROR]" or "[CARD NOT INITIALIZED]" message appears, refer to P.101-102 before formatting the **xD-Picture Card** and take the appropriate measures.

FRAME NO.

	< CONT. >	< RENEW >
A	0001 ⋮ 0005	0001 ⋮ 0005
↓		
B	0006 ⋮ 0010	0001 ⋮ 0005

*Formatted xD-Picture Card used for both A and B.

CONT. : Pictures are stored beginning from the highest file number stored on the last xD-Picture Card used.

RENEW : Pictures are stored on each xD-Picture Card beginning with a file number "0001".

Setting this function to "CONT." makes file management easier as it ensures that file names are not duplicated when images are downloaded to a PC.

⚠ If the xD-Picture Card already contains image files with file numbers higher than the highest file number on the last xD-Picture Card, images are stored beginning from the highest file number on the current xD-Picture Card.

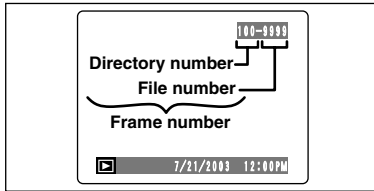

You can check the file number by viewing the image. The last 4 digits of the 7-digit number in the top right corner of the screen are the file numbers, while the first 3 digits show the directory number.

- ⚠ When replacing the xD-Picture Card, always switch the camera off before opening the battery cover. Opening the battery cover without switching the camera off may prevent the Frame number Memory from functioning.
- ⚠ File NO. run from 0001 to 9999. Once 9999 is exceeded, the directory number changes from 100 to 101. The maximum number is 999-9999.
- ⚠ The displayed frame number may differ for images photographed on other cameras.
- ⚠ If the "FILE NO. FULL" message appears, see P.101.

CCD-RAW

Setting CCD-RAW to ON disables the signal processing functions (reconstituting the data received from the CCD as an image) performed on the camera. Consequently, this task must be performed on the computer.

Use the bundled RAW FILE CONVERTER LE software to perform the processing on a computer. Conversion using RAW FILE CONVERTER LE also provides a simple way to create TIFF-format images.

* To rebuild images, FinePixViewer (on the bundled CD-ROM) must be installed on your computer.

■ The functions listed below cannot be used in CCD-RAW mode.

During shooting	Digital zoom, continuous shooting, and FinePix Photo mode (image quality, sensitivity (ISO 800) and FinePix COLOR) are unavailable.
During playback	Playback image quality is fixed at 10 (1280 × 960). Playback can be zoomed up to 800%, but cropped images cannot be saved.

Connect the camera with "USB" selected as the USB setting (→P.88).



Connect the camera with "PC" selected as the USB setting.

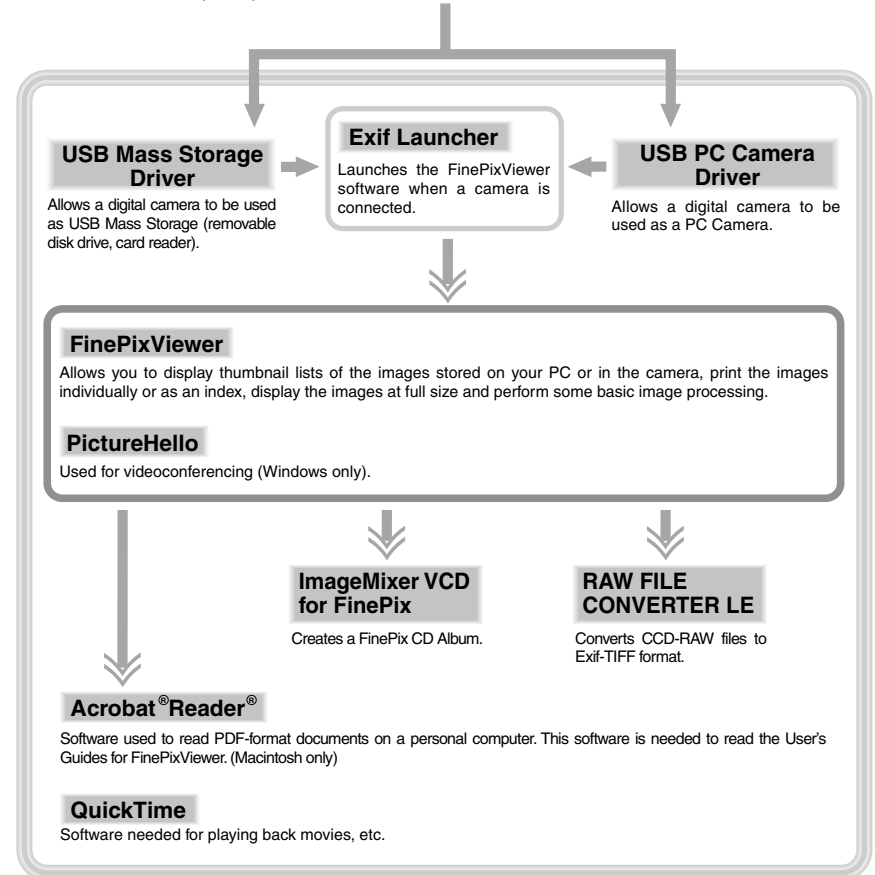

* Note that the software configuration differs slightly depending on your operating system.

5.2 INSTALLATION ON A Windows PC

Pre-installation checklist

To run this software, you must have the hardware and software described below. Check your system before you begin the installation.

Compatible PCs	IBM PC/AT or compatible* ¹
Operating System	Windows 98 (including the Second Edition) Windows Millennium Edition (Windows Me) Windows 2000 Professional* ² Windows XP Home Edition* ² Windows XP Professional* ²
CPU	200 MHz Pentium or better recommended (800 MHz Pentium III or better recommended for Windows XP)
RAM	64 MB minimum (128 MB minimum for Windows XP) Minimum 256 MB when RAW FILE CONVERTER LE is used
Hard disk space	Amount required for installation : 140 MB minimum Amount required for operation : 300 MB minimum (When ImageMixer VCD for FinePix is used : 2 GB or better) Minimum 1 GB when RAW FILE CONVERTER LE is used
Display	800 × 600 pixels or better, 16-bit color or better
Internet connection*³	<ul style="list-style-type: none">To use the FinePix Internet Service or mail attachment function : An Internet connection and E-mail transmission softwareConnection speed : 56 k or better recommended
Sound functions*⁴	Speakers, microphone and sound card

*¹ Models with a USB interface as a standard feature and one of the above operating systems preinstalled.

*² When you install the software, log in using a system administrator account (e.g. "Administrator").

*³ Required to use the FinePix Internet Service and videoconferencing. The software can still be installed even if you do not have an Internet connection.

*⁴ Sound functions are required for videoconferencing.

◆ Notes ◆

- Connect the camera directly to the computer using the USB cable (Mini-B). The software may not operate correctly if you use an extension cable or connect the camera via a USB hub.
- If your computer has more than one USB port, the camera can be connected to either port.
- Push the USB connector fully into the socket to ensure that it is securely connected. The software may not operate correctly if the connection is faulty.
- Additional USB interface board is not guaranteed.
- Windows 95 and Windows NT cannot be used.
- Operation is not guaranteed on home-built computers or on computers running updated operating system software.
- If your Internet connection is via a router or via a LAN (connecting machines on the LAN to the Internet), you cannot use videoconferencing.
- If you are using Windows XP and you tick the "Protect my computer and network by limiting or preventing access to this computer from the Internet" checkbox in the Internet connection firewall settings, videoconferencing cannot be used.
- When you reinstall or remove FinePixViewer, the Internet menu and your user ID and password for the FinePix Internet Service are deleted from your computer. Click the [Register now] button, enter your registered user ID and password and download the menu again.

Do not connect the camera to your PC until the software installation is completed.

- 1 Install FinePixViewer as instructed in the Quick Start Guide.

◆ Launching the installer manually ◆

- ① Double-click the "My Computer" icon.
* Windows XP users should click "My Computer" in the "Start" menu.
- ② Right-click "FINEPIX" (CD-ROM drive) in the "My Computer" window and select "Open".
- ③ Double-click "SETUP" or "SETUP.exe" in the CD-ROM window.

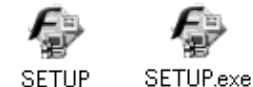

- * The way file names are displayed differs as described below depending on your computer settings.
- File extensions (3-letter suffixes indicating the file type) may be shown or hidden (e.g. Setup.exe or Setup).
 - Text may be shown normally or all in uppercase (e.g. Setup or SETUP).

◆ Installing other applications ◆

You may see messages for installing QuickTime, NetMeeting, ImageMixer VCD for FinePix and WINASPI. Install these applications as directed by the on-screen instructions. The installation screens for these applications are displayed as required.

- 2 After you restart your PC, install DirectX as directed by the on-screen instructions and then restart your PC again. If the latest version of DirectX is already installed on your PC, this installation is not performed.
- 3 After you restart your PC, the "Installation of the FinePixViewer has been completed" message appears.

5.3 INSTALLATION ON A Mac OS 8.6 TO 9.2

Pre-installation checklist

To run this software, you must have the hardware and software described below. Check your system before you begin the installation.

Compatible Mac	Power Macintosh G3*1, PowerBook G3*1, Power Macintosh G4, iMac, iBook, Power Macintosh G4 Cube or PowerBook G4
Operating System	Mac OS 8.6 to 9.2.2*2
RAM	64 MB minimum*3 Minimum 256 MB when RAW FILE CONVERTER LE is used
Hard disk space	Amount required for installation : 110 MB minimum Amount required for operation : 300 MB minimum (When ImageMixer VCD for FinePix is used : 2 GB or better) Minimum 1 GB when RAW FILE CONVERTER LE is used
Display	800 × 600 pixels or better, at least 32,000 colors
Internet connection*4	<ul style="list-style-type: none"> To use the FinePix Internet Service or mail attachment function : An Internet connection and E-mail transmission software Connection speed : 56 k or better recommended

*1 Models with a USB port as a standard feature

*2 This software does not run correctly in the Mac OS X Classic environment.

*3 Turn virtual memory on if necessary.

*4 Required to use the FinePix Internet Service. The software can still be installed even if you do not have an Internet connection.

◆ Notes ◆

- Connect the camera directly to the Macintosh using the USB cable (Mini-B). The software may not operate correctly if you use an extension cable or connect the camera via a USB hub.
- Push the USB connector fully into the socket to ensure that it is securely connected. The software may not operate correctly if the connection is faulty.
- Additional USB interface board is not guaranteed.
- On Macintosh computers, allocate at least 400 MB of virtual memory when RAW FILE CONVERTER LE is used. If other applications will be used at the same time, allocate the additional amount required for those applications also.

◆ Enable file exchange ◆

Check whether File Exchange is active.

To use an **xD-Picture Card** that is supported by the camera, the File Exchange utility supplied with Mac OS must be running.

- 1 Switch on your Macintosh and start up Mac OS 8.6 to 9.2.2.
 - Do not connect the camera to your Macintosh until the software installation is completed.
- 2 Select the Extension Manager in the Control Panel and check that the File Exchange check box is ticked. If not, click in the box so that an appears and then restart your Macintosh.
- 3 When you load the enclosed CD-ROM into the CD-ROM drive, the "FinePix" window automatically opens.
 - If the "FinePix" window does not open automatically, double-click the CD-ROM icon.
- 4 Double-click "Installer for MacOS8.6-9.x" to launch the Installer.

- 5 The Installer setup screen appears. Click the [Installing FinePixViewer] button.

• For more information on what is installed, click the [Read Me First] button and [Using FinePixViewer] button.



- 6 A confirmation message appears asking whether you want to continue with the installation. Click the [OK] button.
- 7 The User License Agreement for this software is displayed. Read the agreement carefully and then, if you agree to the terms of the Agreement, click the [Yes] button. If you click the [No] button, the software is not installed.

- 8 Select the installation destination for FinePixViewer.
 - 1 Click the [Open] button to open the installation destination folder.

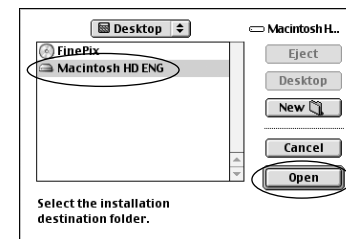

2 Click the [Save] button.

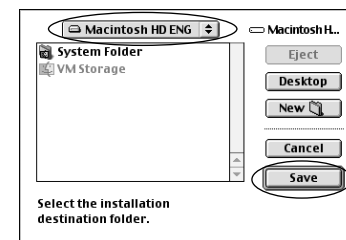

- 9 Install ImageMixer VCD for FinePix as directed by the on-screen instructions.

5.3 INSTALLATION ON A Mac OS 8.6 TO 9.2

10 Install QuickTime as directed by the on-screen instructions and then restart your Macintosh.

If you have already installed QuickTime version 5.0.2 or later, this installation is not performed.



Click [Agree] button in the "License" window.

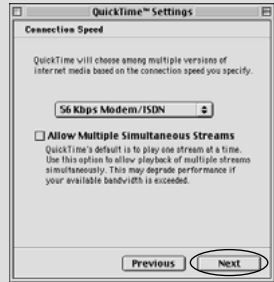

If the "Connection Speed" window appears after you restart your Macintosh, set the correct speed for your environment of connection and then click the [Next] button.

! If you do not know your connection speed, simply click the [Next] button.

11 After you restart your Macintosh, the "FinePixViewer installation completed" message appears. Click "Using FinePixViewer" to view the basic FinePixViewer functions.



12 To install Acrobat Reader, click "Install Acrobat Reader".

You should install Adobe Systems' Acrobat Reader software to read the FinePixViewer User's Guide (PDF). If you already have the latest version installed, this step is not required.

13 Proceed with the installation as directed by the on-screen instructions.

◆ To install Acrobat Reader later... ◆

- ① Double-click the "FinePix" CD-ROM to open the CD-ROM window.
- ② Double-click "FinePixViewer for Mac OS 8.6-9.x" ➔ "Acrobat Reader" ➔ "English" folder.
- ③ Double-click "English Reader Installer".
- ④ Proceed with the installation as directed by the on-screen instructions.

5.4 INSTALLATION ON A Mac OS X

Pre-installation checklist

■ Hardware and software requirements

To run this software, you must have the hardware and software described below. Check your system before you begin the installation.

Compatible Mac	Power Macintosh G3*1, PowerBook G3*1, Power Macintosh G4, iMac, iBook, Power Macintosh G4 Cube, or PowerBook G4
Operating System	Mac OS X (compatible with version 10.0.4 to 10.2.4*2)
RAM	192 MB minimum Minimum 256 MB when RAW FILE CONVERTER LE is used
Hard disk space	Amount required for installation : 110 MB minimum Amount required for operation : 300 MB minimum Minimum 1 GB when RAW FILE CONVERTER LE is used
Display	800 × 600 pixels or better, at least 32,000 colors
Internet connection*3	<ul style="list-style-type: none"> • To use the FinePix Internet Service or mail attachment function : An Internet connection and E-mail transmission software • Connection speed : 56 k or better recommended

*1 Models with a USB port as a standard feature

*2 AVI movies cannot be played back on version 10.0.4.

*3 Required to use the FinePix Internet Service. The software can still be installed even if you do not have an Internet connection.

◆ Notes ◆

- Connect the camera directly to the Macintosh using the USB cable (Mini-B). The software may not operate correctly if you use an extension cable or connect the camera via a USB hub.
- Push the USB connector fully into the socket to ensure that it is securely connected. The software may not operate correctly if the connection is faulty.
- Additional USB interface board is not guaranteed.
- On Macintosh computers, allocate at least 400 MB of virtual memory when RAW FILE CONVERTER LE is used. If other applications will be used at the same time, allocate the additional amount required for those applications also.

■ Functions not supported in FinePixViewer for Mac OS X

Function	Comment
AVI movie playback	Not supported in version 10.0.4
Batch format conversion	Only supported for still images.
Create data for CD writing	Not supported.
Online updating	Information on updates can be obtained using [Support] in the Internet menu.
Online help	Online help can be viewed by opening "English.pdf" in the installation folder.

■ Using the FinePix Internet Service

The user registration procedure for the FinePix Internet Service and the service upload method are different from those used in Mac OS 8.6 to 9.2.2.

5.4 INSTALLATION ON A Mac OS X

FinePixViewer and RAW FILE CONVERTER LE are installed on Mac OS X.

⚠ AVI movies cannot be played back on version 10.0.4.

1 Switch your Macintosh on and start up Mac OS X. Do not launch any other applications.

2 Load the enclosed CD-ROM into the CD-ROM drive. The “FinePix” window opens.

⚠ If the “FinePix” window does not open automatically, double-click the CD-ROM icon.



3 Double-click “Installer for MacOS X”.



4 Click the “” icon. (This operation is not required on version 10.2 (or later).)



5 Enter the administrator name and password. Then click the [OK] button.

⚠ The window displayed in Mac OS X is slightly different.



6 Click the [Continue] button.

7 Quit any other programs that are running and then click the [Continue] button.

8 Click the [Continue] button in the “Software License Agreement” window.

9 Select the Mac OS X startup disk as the installation destination and click the [Continue] button.

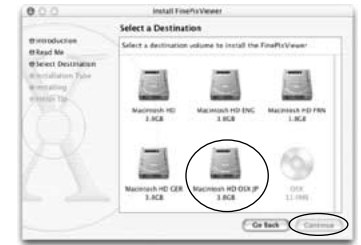

10 Click the [Install (upgrade)] button.

11 Click the [Continue Installation] button. (This operation is not required on version 10.0.x (or later).)

12 When you have completed the installation, click the [Restart] button.



6.1.1 Using the optional AC Power Adapter (sold separately)

It is strongly recommended for using a FUJIFILM AC Power Adapter AC-5VH/AC-5VHS (⇒P.95) in order to avoid losing power at inconvenient times, such as when you are downloading photographed images to your computer. Using the AC power adapter also allows you to take pictures and play back images without worrying about depleting the batteries.

⚠ Only connect or disconnect the AC power adapter when the camera is switched off. Connecting or disconnecting the AC power adapter while the camera is switched on temporarily interrupts the power supply to the camera, so that images or movies being shot at the time are not recorded. Failing to switch the camera off first can also result in damage to the **xD-Picture Card** or malfunctions during PC connection.

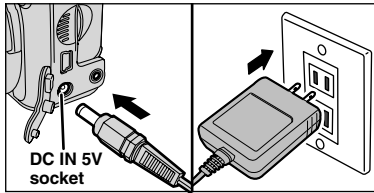

Check that the camera is switched off. Plug the AC power adapter connector into the “DC IN 5V” socket and then plug the AC power adapter into the power outlet.

- ⚠ The socket-outlet shall be installed near the equipment and shall be easily accessible.
- ⚠ The shape of the plug and socket-outlet depends on the country of use.
- ⚠ See P.98 for notes on using the AC power adapter.

Connecting the AC power adapter does not allow you to charge the Ni-MH batteries. Use the optional charger (⇒P.95) to charge the Ni-MH batteries.

6.1.2 Connecting to a TV

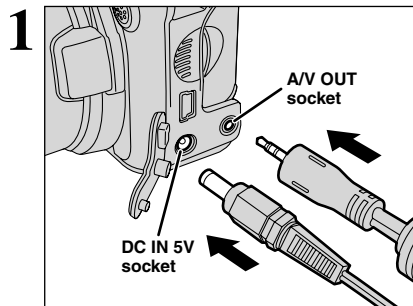

Switch off the camera and TV. Plug the A/V cable (provided with the camera) into the “A/V OUT” (audio/visual output) socket.

- ⚠ If there is a power outlet available, connect the AC-5V AC Power Adapter.

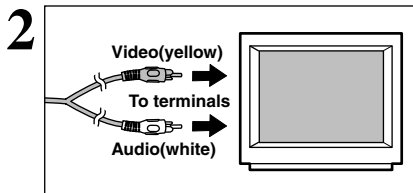

Plug the other end of the cable into the video input socket on the TV. Then switch the camera and TV on and play back images as you would normally.

- ⚠ Images are only sent to the TV in Playback mode.
- ⚠ Refer to the instructions provided with your TV for more information on video input for your TV.

6.1.3 Connecting to a computer

The “Camera Connection” section explains how to connect the camera to your computer using the USB cable (Mini-B) and describes the functions you can use once the camera and computer are connected.

If the power cuts out during data transmission, the data will not be transmitted correctly. Always use the AC power adapter when connecting the camera to a computer.

Refer to Section 5 the first time you connect the camera to your computer. Do not connect the camera with the computer before installing all the software.

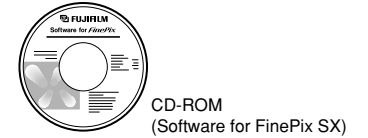

DSC (Mass storage device) mode

This mode provides a simple way to read images from an **xD-Picture Card** and store images on to an **xD-Picture Card** (⇒P.88).

PC CAM (PC Camera) mode

This function allows you to conduct videoconferencing sessions between PCs connected to the Internet.

- ⚠ Videoconferencing (“PictureHello”) is not supported on Macintosh computers.
- ⚠ Connection is only possible with a FUJIFILM camera equipped with a “PC Camera” function.

For more information on using the software, refer to “How to use FinePixViewer” in the HELP menu which was installed from the CD-ROM.

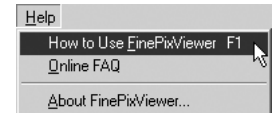

You can switch between “DSC” and “PC” in the camera’s SET-UP screen.

6.1 CAMERA CONNECTION

USE AT DSC MODE

1 Set a camera

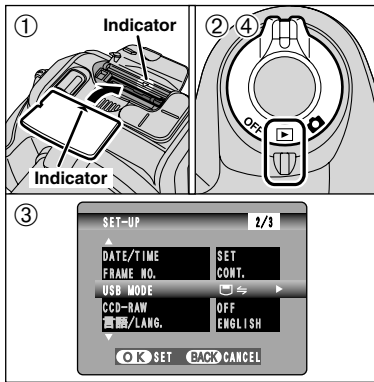

- ① Load an **xD-Picture Card** containing photographed images into your camera. Plug the AC power adapter connector into the "DC IN 5V" socket on the camera and then plug the adapter itself into the main power outlet.
- ② Turn the Power switch to turn the camera on.
- ③ Set the "USB MODE" setting in the "SET-UP" menu to "DSC" (→P.73).
- ④ Turn the Power switch again to turn the camera off.

⚠ It is recommended that you connect the AC Power Adapter AC-5V. Constant power supply will prevent successful data transfer from trouble caused by power supply.

2 Connect a camera to a computer

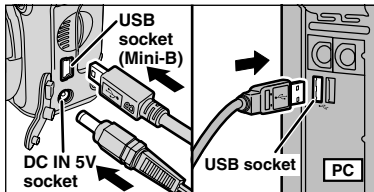

- ① Switch your PC on.
- ② Use the USB cable (Mini-B) to connect the camera to your computer.
- ③ Switch the camera on.

⚠ Take care to ensure that the USB cable (Mini-B) is connected the correct way around and that the plugs are pushed fully into the connection sockets.

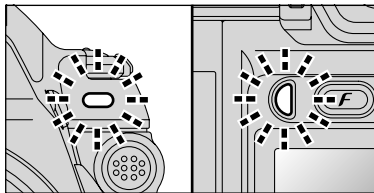

- When the camera and computer are exchanging data, the self-timer lamp blinks and the indicator lamp blinks alternately green and orange.
 - "DSC" appears on the screen.
 - Power Save and Auto Power Off are disabled during USB connection.
- ⚠ Before replacing the **xD-Picture Card**, always disconnect the camera from the PC using the procedure on P.91.
- ⚠ Do not disconnect the USB cable when the camera is communicating with the PC. See P.91 for information on the disconnection procedure.

3 Set a computer

Windows 98/98 SE/Me/2000 Professional/Macintosh

⚠ The Windows CD-ROM may also be required during installation. In this event, switch CD-ROMs as directed by the on-screen instructions.

- FinePixViewer automatically starts up.



* Screen for Windows 98 SE

- A removable disk icon appears and you can use your PC to transfer files to and from the camera.



If the above operations do not occur, you do not have the required software programs or drivers installed on your PC. Complete the required PC setup procedures. Then reconnect the camera to your PC.

6.1 CAMERA CONNECTION

Windows XP

① The “Found New Hardware” help message appears in the bottom-right corner of your screen. This message will close when the settings are completed. No action is required.

🔧 This step is not required for subsequent connections.



② Specify the settings in the “AutoPlay” dialog box.

● **When FinePixViewer is included in the list of actions to perform**

Select “Viewing images using FinePixViewer” and then select the “Always do the selected action” checkbox. (This checkbox may not be shown in some cases.) Click the [OK] button to launch FinePixViewer.

● **When FinePixViewer is not included in the list of actions to perform**

Select “Take no action” and then select the “Always do the selected action” checkbox. (This checkbox may not be shown in some cases.) Click the [OK] button and launch FinePixViewer manually.

③ A new removable disk icon appears in the “My Computer” window.

◆ **Regarding the icons** ◆

The next time you connect the camera, the removable disk drive icon and name change to the “FinePix” icon and name.

Proceed to “USING FinePixViewer” on page 92.

6.1.4 Disconnecting the camera

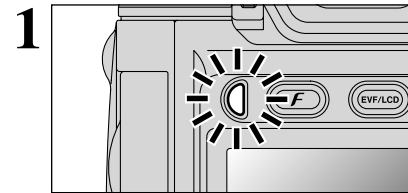

① Quit all applications (FinePixViewer etc.) that are using the camera.
② Check that the indicator lamp is lit green or that the self-timer lamp is off (no data is being exchanged with the computer).

For a DSC connection, proceed to step 2.
For a PC Camera connection, proceed to step 3.

🔧 Even when “Copying” is no longer displayed on the computer, the camera and the computer may still be exchanging data. Always check that the indicator lamp is lit green or that the self-timer lamp is off.

2 Perform the steps shown below before you switch the camera off. This procedure differs depending on the operating system software (or PC) you are using.

Windows 98/98 SE

No PC operation is needed.

Windows Me/2000 Professional/XP

① Right-click the removable disk icon in the “My Computer” window and select Eject. This step is only required in Windows Me.

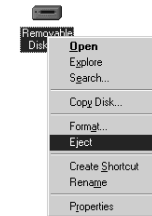

② Left-click the Eject icon in the taskbar and select “USB Disk”.

* Screen for Windows Me



③ The menu option shown below appears. Click on this option.

* Screen for Windows Me



④ The “Safe To Remove Hardware” message box appears. Click the [OK] button or the close button.

Macintosh

Drag the “Removable drive” icon on the desktop to the Trash.

🔧 When you drag the icon to the Trash, “REMOVE OK” appears on the camera’s screen.

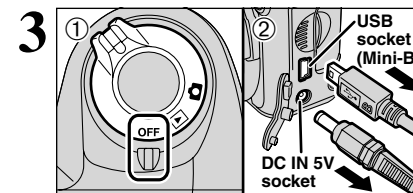

① Switch the camera off.
② Unplug the USB cable (Mini-B) from the camera.

6.2 USING FinePixViewer

6.2.1 Mastering FinePixViewer

For all information on FinePixViewer functions, refer to “How to Use FinePixViewer” in the Help menu for details.

◆ Macintosh ◆

● To read “How to Use FinePixViewer”...

You must install Adobe Systems' Acrobat Reader. See P.82 for information on installing Acrobat Reader.

🔗 For more information on using Acrobat Reader, refer to the Acrobat Reader “Help” menu.

● What is explained in “How to Use FinePixViewer”...

“How to Use FinePixViewer” covers a range of topics, including batch processing and ordering prints.

■ Example : Looking up slide shows

- 1 Click “How to Use FinePixViewer” in the FinePixViewer Help menu.
- 2 Click “Basic Operation” and then click “Basic Slide Show Operations” in the menu that appears.
- 3 The “Basic Slid Show Operations” information is displayed. Press the “<<<” key to view the previous page or the “>>>” key to view the next page.

6.2.2 Uninstalling the software

Only perform this operation when you no longer require the installed software or when the software was not installed correctly.

Windows

- 1 Switch on your PC.
- 2 Disconnect the camera (➡P.91).
- 3 Quit all currently running applications.
- 4 Close all files.
- 5 Open the “My Computer” window, open the “Control Panel”, and double-click “Add/Remove Programs”.



- 6 The “Add/Remove Programs Properties” window appears. Select the software to be uninstalled (FinePixViewer or the driver) and then click the [Add/Remove] button.

<To remove FinePixViewer>

FinePixViewer Ver.4.0

<To remove the driver software>

FUJIFILM USB Driver



- 7 When the confirmation message appears, click the [OK] button. Check your selection carefully since the process cannot be cancelled once you click [OK] button.



- 8 Automatic uninstallation begins. When uninstallation ends, click the [OK] button.

Macintosh

- 1 Only perform this operation when you no longer require the installed software or when the software was not installed correctly.

Mac OS 8.6-9.2.2

■ Uninstalling Mass Storage Driver and PC Camera Driver

- 1 Check that the camera is not connected to your Macintosh.
- 2 Open the “Extensions” folder in the System folder, and then drag all the files that begin with “USB04CB...” to the Trash.
- 3 Restart your Macintosh.
- 4 Select “Empty Trash” in the “Special” menu.

■ Uninstalling Exif Launcher, FinePixViewer and DP Editor

- 1 After you have quit Exif Launcher in “Exif Launcher Settings” in the FinePixViewer “Settings” menu, move the Exif Launcher file from the “Startup Items” folder in the System folder to the Trash. Then select “Empty Trash” in the “Special” menu.
- 2 After you have exited FinePixViewer and DP Editor drag the installed FinePixViewer folder to the Trash. Then click “Empty Trash” in the “Special” menu.

Mac OS X

■ Uninstalling FinePixViewer

Quit FinePixViewer and DP Editor. Then drag the installed FinePixViewer folder to the Trash and select “Empty Trash” in the “Special” menu.

System Expansion Options

- By using the FinePix S5000 together with other optional FUJIFILM products, your system can be expanded to fill a wide range of uses.

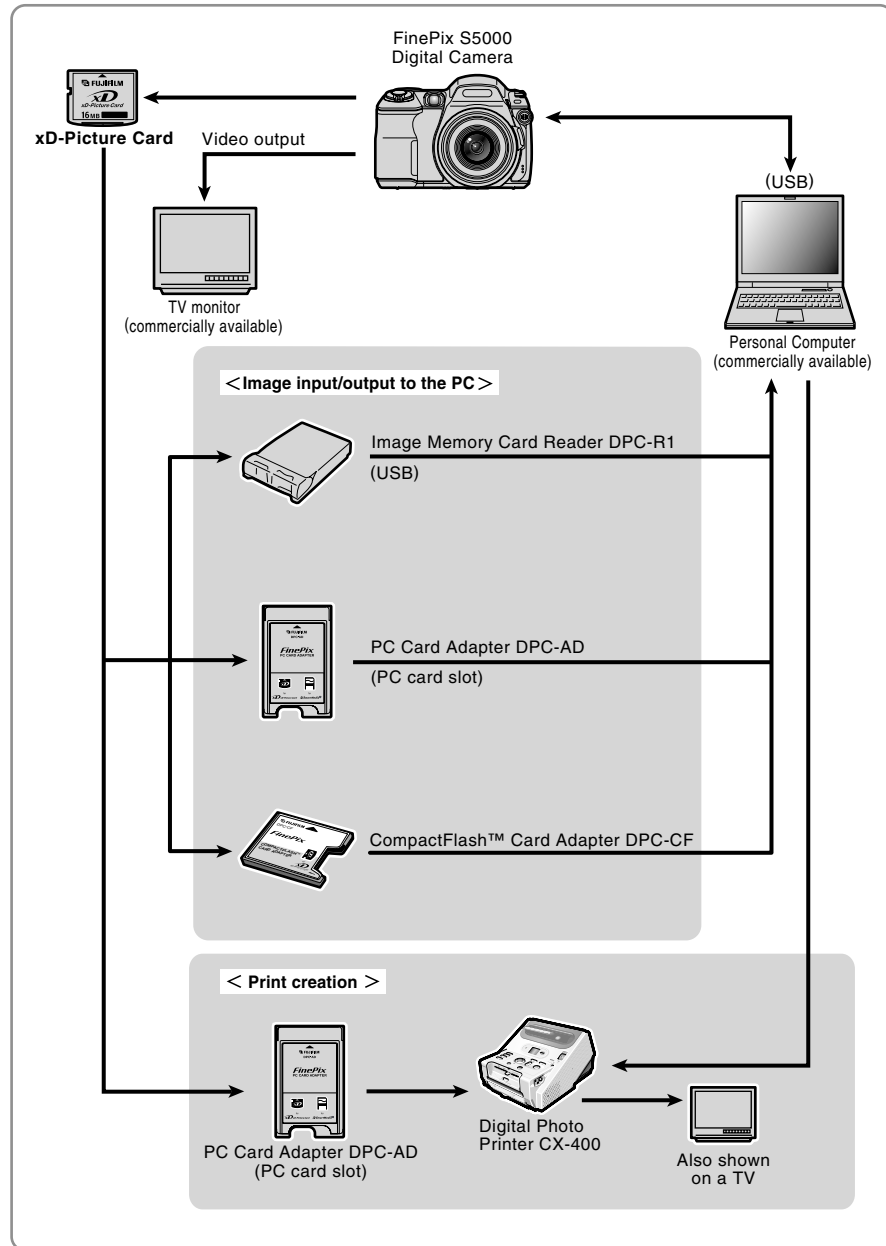

Accessories Guide

- The optional accessories (sold separately) can make taking pictures with the FinePix S5000 even easier. For information on how to attach and use the accessories, refer to the instructions provided with the accessory used. Visit the FUJIFILM web site for the latest information on camera accessories. <http://home.fujifilm.com/products/digital/index.html>

● xD-Picture Card

These are separately available xD-Picture Card.

Use the following xD-Picture Card :

- DPC-16 (16 MB)/DPC-32 (32 MB)/DPC-64 (64 MB)/DPC-128 (128 MB)/DPC-256 (256 MB)/DPC-512 (512 MB)



● Fujifilm Rechargeable Battery 2HR-3UF (2×)

The 2HR-3UF includes 2 high-capacity AA-size Nickel-Metal Hydride (Ni-MH) batteries.

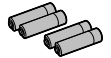

● Fujifilm Battery charger with Battery BK-NH/BK-NH2 (With Euro type or UK type plug)

The BK-NH/BK-NH2 includes the quick battery charger BCH-NH/BCH-NH2 and 2 Ni-MH batteries.

The BCH-NH/BCH-NH2 can charge 2 Ni-MH batteries in approximately 120 minutes.

Up to 4 Ni-MH batteries can be charged simultaneously.

- The BK-NH and BK-NH2 are provided with 1700 mAh and 2100 mAh batteries respectively. The bundled batteries can be charged up to their respective full capacities.

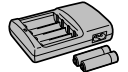

● AC Power Adapter AC-5VH/AC-5VHS

Use the AC-5VH/AC-5VHS when you want to take pictures or play back images for long periods or when the FinePix S5000 is connected to a personal computer.

- * The shape of the AC power adapter, the plug and socket outlet depend on the country.

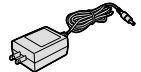

● Carrying Case SC-FXS5

Special case made from leather/polyester. This is designed to protect the camera against dirt, dust and light knocks while you are carrying it.

● Image Memory Card Reader DPC-R1

The DPC-R1 provides a quick and easy way to transfer images back and forth between your PC and an image memory card (xD-Picture Card and SmartMedia). The DPC-R1 uses the USB interface for high-speed file transfer.

- Compatible with Windows 98/98 SE, Windows Me, Windows 2000 Professional, Windows XP or iMac, Mac OS 8.6 to 9.2.2, Mac OS X (10.1.2 to 10.1.5) and models that support USB as standard.
- Compatible with xD-Picture Card of 16 MB to 512 MB, and SmartMedia of 3.3V, 4 MB to 128 MB.

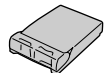

● PC Card Adapter DPC-AD

The PC Card Adapter allows the xD-Picture Card and SmartMedia to be used as a PC Card Standard ATA-compliant (PCMCIA 2.1) PC card (Type II).

- Compatible with xD-Picture Card of 16 MB to 512 MB, and SmartMedia of 3.3V, 2 MB to 128 MB.



● CompactFlash™ Card Adapter DPC-CF

Inserting an xD-Picture Card into this adapter allows you to use the card as a CompactFlash card (Type I).

- Windows 95/98/98 SE/Me/2000 Professional/XP
- Mac OS 8.6 to 9.2.2/X (10.1.2 to 10.1.5)



Conversion Lens Guide (sold separately)

Wide conversion lens WL-FX9/WL-FX9B

Changes the focal length by a factor of 0.79× (wide-angle : equivalent to 30 mm) without altering the F-stop value of the lens.

● Wide conversion lens specifications

Magnification	: 0.79×
Lens configuration	: 3 lenses in 3 groups
Shooting range	: Approx. 0.9 m to infinity
Dimensions	: 70 mm (2.76 in.) dia. × 32 mm (1.26 in.)
Mass (Weight)	: Approx. 185 g (6.5 oz.)
Accessories	: Adapter ring AR-FX9 (see below remarks), Lens caps (front and rear), Lens pouch

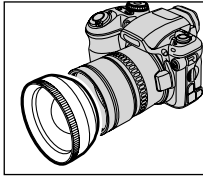

* Except for body color, the specifications of the WL-FX9 and WL-FX9B are the same.

WL-FX9 : Silver
WL-FX9B : Black

⚠ The adapter ring enclosed with the FinePix S5000(AR-FX5) should be used with this conversion lens. The adapter rings provided with these conversion lenses (AR-FX9 for FinePix 4900 zoom/6900 zoom/S602 zoom) cannot be used with the FinePix S5000.

⚠ Only use the wide conversion lens at the wide-angle zoom setting.

⚠ The built-in flash cannot be used when the wide conversion lens is mounted.

⚠ Commercially available filters can be mounted on the lens when the adapter ring is attached, but no more than one filter should be mounted at a time.

Teleconversion lens TL-FX9/TL-FX9B

Changes the focal length by a factor of 1.5× (telephoto : equivalent to 555 mm) without altering the F-stop value of the lens.

● Teleconversion lens specifications

Magnification	: 1.5×
Lens configuration	: 3 lenses in 3 groups
Shooting range	: Approx. 5.0 m to infinity
Dimensions	: 65 mm (2.56 in.) dia. × 55 mm (2.17 in.)
Mass (Weight)	: Approx. 100 g (3.5 oz.)
Accessories	: Adapter ring AR-FX9 (see below remarks), Lens caps (front and rear), Lens pouch

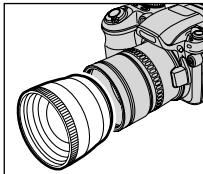

* Except for body color, the specifications of the TL-FX9 and TL-FX9B are the same.

TL-FX9 : Silver
TL-FX9B : Black

⚠ The adapter ring enclosed with the FinePix S5000(AR-FX5) should be used with this conversion lens. The adapter rings provided with these conversion lenses (AR-FX9 for FinePix 4900 zoom/6900 zoom/S602 zoom) cannot be used with the FinePix S5000.

⚠ Only use the tele conversion lens at the telephoto zoom setting.

⚠ The built-in flash cannot be used when the teleconversion lens is mounted.

⚠ Commercially available filters can be mounted on the lens when the adapter ring is attached, but no more than one filter should be mounted at a time.

Notes on Using Your Camera Correctly

▶ Be sure to read this information in conjunction with “Safety Notes” (→P.108), to ensure that you use your camera correctly.

■ Places to avoid

Do not store or use the camera in the following types of locations :

- In the rain or in very humid, dirty or dusty places
- In direct sunlight or in places subject to extreme temperature rises, such as in a closed car in summer
- Extremely cold places
- Places subject to strong vibration
- Places affected by smoke or steam
- Places subject to strong magnetic fields (such as near motors, transformers or magnets)
- In contact with chemicals such as pesticides or next to rubber or vinyl products for long periods of time

■ Notes on immersion in water or sand

The FinePix S5000 is particularly adversely affected by water and sand. When you are at the beach or close to water, ensure that the camera is not exposed to water or sand. Take care not to place the camera on a wet surface. Water or sand inside the camera can cause faults that may be irreparable.

■ Notes on condensation

If the camera is carried suddenly from a cold location into a warm place, water droplets (condensation) may form on the inside of the camera or on the lens. When this occurs, switch the camera off and wait an hour before using the camera. Condensation may also form on the **xD-Picture Card**. In this event, remove the **xD-**

Picture Card and wait a short time before using it again.

■ When the camera is unused for long periods

If you do not intend to use the camera for a long period of time, remove the battery and the **xD-Picture Card** before storing the camera.

■ Cleaning your camera

- Use a blower brush to remove dust from the lens, LCD monitor screen or viewfinder, and then wipe lightly with a soft, dry cloth. If any soil remains, apply a small amount of lens cleaning liquid to a piece of FUJIFILM lens cleaning paper and wipe gently.
- Do not scratch hard objects against the lens, LCD monitor screen or viewfinder as these surfaces are easily damaged.
- Clean the body of the camera with a soft, dry cloth. Do not use volatile substances such as thinners, benzine or insecticide, as these may react with camera body and cause deformation or remove the coating.

■ Using the camera overseas

When travelling overseas, do not place your camera in the check-in baggage. Baggage handling at airports may subject baggage to violent shocks, and the camera may be damaged internally even when no external damage is visible.

Notes on the Power Supply

Applicable Batteries

- In the camera, use AA-size alkaline or nickel-metal hydride batteries.
Do not use AA-size manganese or nickel-cadmium (Ni-Cd) batteries in your FinePix S5000 because the heat generated by the batteries could damage the camera or cause malfunctions.
- The operating lives of alkaline batteries vary between brands and the life of batteries you purchase may be shorter than the alkaline batteries provided with the camera.

Notes on the Batteries

Incorrect use of the batteries could cause them to leak, become hot, ignite or burst. Always observe the precautions given below.

- Do not heat the batteries or throw them into a fire.
- Do not carry or store a battery with metal objects such as necklaces or hairpins that could come into contact with the metal positive ⊕ and negative ⊖ poles of the battery.
- Do not expose the batteries to fresh or sea water, and take particular care to keep the terminals dry.
- Do not attempt to deform, disassemble or modify the batteries.
- Do not attempt to peel off or cut the battery outer casing.
- Do not drop, strike or otherwise subject the batteries to strong impacts.

- Do not use batteries that are leaking, deformed, discolored or exhibit any other obvious abnormality.
- Do not store batteries in very warm or moist locations.
- Keep the batteries out of reach of babies and small children.
- When loading the batteries into the camera, ensure that the battery polarity (⊕ and ⊖) is as indicated on the camera.
- Do not use a new battery together with a used battery. In the case of rechargeable batteries, do not use charged and discharged batteries together. Do not use batteries of different types or brands together.
- If you do not intend to use the camera for a long period of time, remove the batteries from the camera. (Note that if the camera is left with the batteries removed, the time and date settings are cleared.)
- The batteries may feel warm immediately after being used. Before removing the batteries, switch the camera off and wait until the batteries cool down.
- When replacing the batteries, always fit 4 new batteries.
Here, “new batteries” denotes newly purchased unused alkaline batteries or a pair of fully charged AA-size Ni-MH batteries that were charged at the same time.
- In cold locations (at temperatures of +10°C/+50°F or below), battery performance deteriorates and the time for which they can be used shortens markedly. This is particularly true of alkaline batteries. In cold

Notes on the Power Supply

conditions, put the batteries in your pocket or a similar place to warm them before loading them into the camera. If you use a body warmer to warm the batteries, ensure that they are not in direct contact with the warmer.

- Soil (such as fingerprints) on the battery terminals can markedly reduce the number of available frames. Carefully wipe the battery terminals clean with a soft dry cloth before loading the batteries.

⚠ If any liquid at all leaks from the batteries, wipe the battery compartment thoroughly and then load new batteries.

⚠ If any battery fluid comes into contact with your hands or clothing, flush the area thoroughly with water. Note that battery fluid can cause loss of eyesight if it gets into your eyes. If this occurs, do not rub your eyes. Flush the fluid out with clean water and contact your physician for treatment.

Notes on using the AA-size Ni-MH batteries correctly

- As a power source in digital cameras, AA-size Ni-MH batteries are superior to alkaline batteries in several ways, such as allowing more shots to be taken with the camera. However, care must be taken with the way Ni-MH batteries are used if their original performance is to be maintained.
- Ni-MH batteries left unused in storage for long periods can become "deactivated". Also, repeatedly charging Ni-MH batteries that are only partially discharged can cause them to suffer from the "memory effect".
- Ni-MH batteries that are "deactivated" or affected by "memory" suffer from the problem of only providing power for a short time after being charged. To prevent this problem, discharge and recharge them several times using the camera's "Discharging rechargeable batteries" function. By repeating this cycle several times, the temporary reduction in performance caused by "memory" or "deactivation" can be remedied and the batteries can be restored to their original performance levels.
- Deactivation and memory are specific to Ni-MH batteries and are not in fact battery faults. See P.99 for the procedure for "Discharging rechargeable batteries".

Do not use the "Discharging rechargeable batteries" function when alkaline batteries are being used.

- To charge Ni-MH batteries, use the quick battery charger (sold separately). Refer to the instructions supplied with the charger to ensure that the charger is used correctly.
- Do not use the battery charger to charge batteries other than those specified for use with the charger.
- Note that the batteries may feel warm immediately after being charged.
- Due to the way the camera is constructed, a small amount of current is used even when the camera is switched off. Note in particular that leaving Ni-MH batteries in the camera for a long period will overdischarge the batteries and may render them unusable even after recharging.
- Ni-MH batteries will self-discharge even when not used, and the time for which they can be used may

be shortened as a result.

- Ni-MH batteries will deteriorate rapidly if overdischarged (eg. by discharging the batteries in a flashlight). Use the "Discharging rechargeable batteries" function provided in the camera to discharge the batteries.
- Ni-MH batteries have a limited service life. If a battery can only be used for a short time even after repeated discharge-charge cycles, it may have reached the end of its service life.

Disposing of Batteries

When disposing of batteries, do so in accordance with your local waste disposal regulations.

AC Power Adapter

Always use the AC-5VH/AC-5VHS AC Power Adapter with the camera.

The use of an AC power adapter other than AC-5VH/AC-5VHS could result in damage to your digital camera.

- This AC power adapter is designed exclusively for indoor use.
- Plug the connection cord plug securely into the DC input terminal of the FUJIFILM Digital camera.
- Turn off the power switch of the FUJIFILM Digital camera before disconnecting the connection cord from the FUJIFILM Digital camera's DC input terminal. To disconnect, take hold of the plug and pull it out (do not disconnect it by pulling on the cord).
- Do not use this AC power adapter with any device except the specified device.
- During use, this AC power adapter will become hot to the touch, but this is normal.
- Do not disassemble the AC power adapter. Doing so could be dangerous.
- Do not use this device in a place with high temperature and high humidity.
- Do not drop or subject this device to strong shocks.
- This device may emit a humming noise, but this is normal.
- If used near a radio, this device may cause static, so play the radio in a distant place.

Procedure for discharging rechargeable Ni-MH batteries

Only use the "Discharging rechargeable batteries" function with Ni-MH batteries (rechargeable batteries).

The "Discharging rechargeable batteries" function should not be used with alkaline batteries as it will completely drain the battery charge.

Use the "Discharging rechargeable batteries" function in the following situations :

- When the batteries can only be used for a short time after being charged normally
- When the batteries have not been used for a long period
- When you purchase new Ni-MH batteries

Do not use the "Discharging rechargeable batteries" function while using the AC power adapter. In these situations, the Ni-MH batteries will not be discharged due to the external power supply.

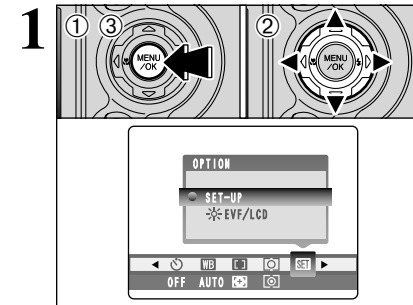

- ① Press the "MENU/OK" button.
- ② Press "◀" or "▶" to select "SET-UP" OPTION and then press "▲" or "▼" to select "SET-UP".
- ③ Press the "MENU/OK" button.

⚠ Do not use the procedure for discharging rechargeable batteries with alkaline batteries.

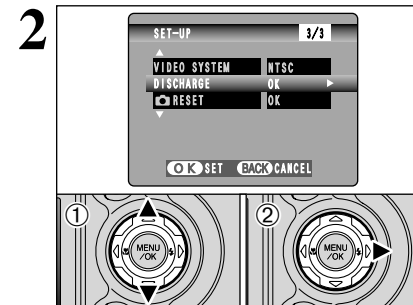

- ① Press "▲" or "▼" to select "DISCHARGE".
- ② Press "▶".

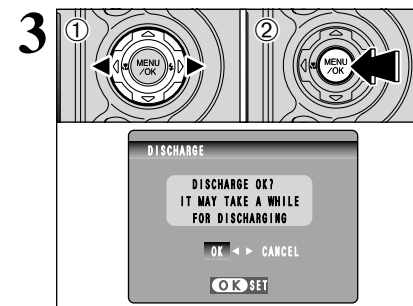

- ① Press "◀" or "▶" to select "OK".
 - ② Press the "MENU/OK" button.
- The screen changes and discharging begins. When the battery level indicator blinks red and discharging ends, the camera switches off.

- ⚠ Discharging takes a maximum of 15 hours.
- ⚠ To cancel discharging, press the "BACK" button.

Notes on the xD-Picture Card™

■ Image memory card

- This Image Memory Card is a new image recording media (**xD-Picture Card**) developed for digital cameras. The Image Memory Card consists of a semiconductor memory (NAND-type flash memory) to record digital image data. The recording process is electrically performed and enables erasure of existing image data as well as re-recording of new image data.
- When using a new Memory Card, or a Memory Card that has been initialized by a PC, be sure to initialize (format/initialize) the card with your digital camera before using it.

■ Protecting your data

- Data may be lost or destroyed in the following situations. Please note that FUJIFILM assumes no responsibility for data that is lost or destroyed.
 1. Removal of the memory card or turning the power off while the memory card is being accessed (i.e., during record, erase, initialization, and playback operations).
 2. Improper handling and use of the memory card by the user or third party.
- We recommend saving your important data to another media (i.e., MO disk, CD-R, hard disk, etc.).

■ Notes on handling xD-Picture Card

- Keep **xD-Picture Cards** out of the reach of small children. When storing **xD-Picture Cards**, ensure that they are kept in a location out of the reach of small children to prevent a card being accidentally swallowed. An **xD-Picture Card** could cause suffocation if accidentally swallowed. If a child swallows an **xD-Picture Card**, seek medical advice immediately.
- Make sure that the memory card is straight when you insert into the camera etc.
- The memory card is a precision electronic instrument. Do not apply pressure or shock, and avoid bending.
- Do not use the memory card in a hot, humid, or corrosive environment.
- If the contact area on the card is soiled (dust, fingerprints, etc.), wipe it clean with a soft, dry cloth.
- Clean the memory card with a soft dry piece of cloth when dirty.
- **xD-Picture Cards** should be kept in their special cases or carrying cases when being stored or carried around.
- The memory card can be used reliably for a long period of time, but will eventually lose its ability to store and play back image data. At this point, replace with a new memory card.
- Never remove the **xD-Picture Card** or switch the camera off during data recording, during data erasing (**xD-Picture Card** formatting) or during frame advance when images are being played back. These actions could result in damage to the **xD-Picture Card**.
- The use of **xD-Picture Cards** is recommended with the FinePix S5000. The camera quality cannot be guaranteed when cards other than those manufactured by FUJIFILM are used.
- The **xD-Picture Card** may feel warm when it is removed from the camera after extended periods of picture taking or image viewing. This is normal and does not indicate a fault.









- Do not affix labels to the **xD-Picture Card**. This could result in the label peeling off and causing a fault when the card is inserted or removed.
- **Notes on using xD-Picture Card with a PC**
 - If you intend to take photos using an **xD-Picture Card** that has been used on a PC, format the **xD-Picture Card** on your camera.
 - When you format an **xD-Picture Card** in the camera and then shoot and record images, a directory (folder) is automatically created. Image data is then recorded in this directory.
 - Do not change or delete the directory (folder) names or file names on the **xD-Picture Card** from your PC as this will make it impossible to use the **xD-Picture Card** in your camera.
 - Always use the camera to erase image data on an **xD-Picture Card**.
 - To edit image data, copy the image data to the PC's hard disk and then edit the copied data.
 - Do not copy files other than those that will be used by the camera.

■ Specifications







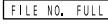



Type	Image memory card for digital cameras (xD-Picture Card) NAND-type flash memory
Memory type	Temperature : 0°C to +40°C (+32°F to +104°F)
Conditions for use	Humidity : 80% max. (no condensation) 25 mm × 20 mm × 2.2 mm (0.98 in. × 0.79 in. × 0.09 in.) (W × H × D)
Dimensions	

Warning Displays

► The table below lists the warnings that are displayed on the monitor.

Warning Displayed	Explanation	Remedy
 (Lit red)  (Blinking red)	The camera batteries are low or completely out of charge.	Fit new or fully charged batteries.
	There is a strong likelihood of camera shake because the shutter speed is slow.	Use flash photography. The use of a tripod is recommended.
!AF	The AF (auto focus) cannot work effectively.	<ul style="list-style-type: none"> ● If the image is too dark, take the picture at a distance of around 2 m (6.6 ft.) from the subject. ● Use AF lock to take the picture.
Aperture/ Shutter speed display (Lit red)	Outside the AE continuous range.	The shot can be taken, but the exposure will not be correct.
	No xD-Picture Card is inserted.	Insert an xD-Picture Card .
	<ul style="list-style-type: none"> ● The xD-Picture Card is not formatted. ● The xD-Picture Card contact area is soiled. 	<ul style="list-style-type: none"> ● Format the xD-Picture Card. ● Wipe the contact area on the xD-Picture Card with a soft dry cloth. It may be necessary to format the xD-Picture Card. If the error message is still displayed, replace the xD-Picture Card. ● Contact your FUJIFILM dealer.
	<ul style="list-style-type: none"> ● The xD-Picture Card contact area is soiled. ● The xD-Picture Card is damaged. ● The xD-Picture Card format is incorrect. ● Camera fault. 	<ul style="list-style-type: none"> ● Wipe the contact area on the xD-Picture Card with a soft dry cloth. It may be necessary to format the xD-Picture Card. If the error message is still displayed, replace the xD-Picture Card. ● Contact your FUJIFILM dealer.
	The xD-Picture Card is fully recorded.	Erase some images or use an xD-Picture Card that has ample free space.
	<ul style="list-style-type: none"> ● The file played back was not recorded correctly. ● The xD-Picture Card contact area is soiled. 	<ul style="list-style-type: none"> ● Images cannot be played back. ● Wipe the contact area on the xD-Picture Card with a soft dry cloth. It may be necessary to format the xD-Picture Card. If the error message is still displayed, replace the xD-Picture Card. ● Contact your FUJIFILM dealer. ● Movies cannot be played back.
	The frame number has reached 999-9999.	<ol style="list-style-type: none"> ① Insert a formatted xD-Picture Card into the camera. ② Set "RENEW" as the FRAME NO. setting in the SET-UP menu. ③ Start taking pictures. (The frame numbers start from "100-0001".) ④ Set "CONT." as the FRAME NO. setting in the SET-UP menu.

Warning Displays

Warning Displayed	Explanation	Remedy
	<ul style="list-style-type: none"> The data could not be recorded due to an xD-Picture Card error or a connection error between the xD-Picture Card and camera. The photographed image cannot be recorded as it is too large to fit in the available space on the xD-Picture Card. 	<ul style="list-style-type: none"> Re-insert the xD-Picture Card or switch the camera off and then on again. Use a new xD-Picture Card.
	A protected file was encountered.	Protected files cannot be erased. Remove the protection.
	Prints were specified for more than 1000 frames in the DPOF frame settings.	The maximum number of frames for which prints can be specified on the same xD-Picture Card is 999. Copy the images for which you want to order prints onto another xD-Picture Card and then specify the DPOF settings.
 	Camera malfunction or fault.	<ul style="list-style-type: none"> Switch the camera on again, taking care not to touch the lens. Switch the camera off and on again.
	<ul style="list-style-type: none"> The voice memo file is faulty. Camera fault. 	<ul style="list-style-type: none"> The voice memo cannot be played back. Contact your FUJIFILM dealer.
 CAN NOT USE F-MODE	CCD-RAW is set to ON in SET-UP.	Set CCD-RAW to OFF in SET-UP (→P.73).
 CAN NOT SET DPOF  CAN NOT SET DPOF  CAN NOT SET DPOF	An attempt was made to specify DPOF settings for an image that is not supported by DPOF.	DPOF printing cannot be used with this image format.
	The timing for recording was incorrect because the xD-Picture Card was formatted on a computer.	Use an xD-Picture Card that was formatted on the camera.

Troubleshooting

▶ If you think the camera is faulty, check the following once more.

Troubleshooting	Possible causes	Solutions
No power.	<ul style="list-style-type: none"> The batteries have run out. The batteries are loaded backwards. The battery cover is not closed properly. The AC power adapter plug has come out of the power outlet. 	<ul style="list-style-type: none"> Fit new or fully charged batteries. Load the batteries in the correct direction. Close the battery cover correctly. Plug the adapter back in.
Power cuts out during operation.	The batteries run out.	Fit new or fully charged batteries.
Batteries run out quickly.	<ul style="list-style-type: none"> You are using the camera in extremely cold conditions. The terminals are soiled. The batteries get un-rechargeable. 	<ul style="list-style-type: none"> Put the batteries in your pocket or another warm place to heat it and then load it into the camera just before you take a picture. Wipe the battery terminals with a clean, dry cloth. Fit new batteries.
No photograph is taken when the Shutter button is pressed.	<ul style="list-style-type: none"> No xD-Picture Card is inserted. The xD-Picture Card is fully recorded. The xD-Picture Card is not formatted. The xD-Picture Card contact area is soiled. The xD-Picture Card is damaged. The camera was not used for 2 minutes. The batteries run out. 	<ul style="list-style-type: none"> Insert an xD-Picture Card. Insert a new xD-Picture Card or erase some unwanted frames. Format the xD-Picture Card. Wipe the xD-Picture Card contact area with a clean dry cloth. Insert a new xD-Picture Card. Switch the camera on. Fit new or fully charged batteries.
The flash settings are restricted and cannot be selected.	Scene position mode is selected.	The flash settings are restricted because the camera settings are tailored to the scene being shot. Change the Photography mode for a wider range of flash settings.
Can't set exposure compensation.	The Photography mode is set to Auto, Scene position or Manual.	Change the Photography mode.
Can't use the flash to take pictures.	<ul style="list-style-type: none"> The flash is set to Suppressed flash mode. You pressed the Shutter button while the flash was charging. The batteries run out. 	<ul style="list-style-type: none"> Set the flash mode to Auto, Red-eye reduction or Forced flash (The flash cannot be used in some modes). Wait until charging is completed before pressing the Shutter button. Fit new or fully charged batteries.
I can only select "Suppressed Flash" Flash mode.	Continuous shooting is selected.	Set continuous shooting to OFF.
Can't select the "BM" quality settings.	<ul style="list-style-type: none"> The sensitivity is set to 800 (high-sensitivity photography) in the Photography menu. The continuous shooting option in the Photography menu is set to "Long-period Continuous Shooting". 	<ul style="list-style-type: none"> In the Photography menu, set the sensitivity to 400 or less. Set the continuous shooting option to something other than "Long-period Continuous Shooting".
The playback image is too dark even though the flash was used.	<ul style="list-style-type: none"> The subject is too far away. Your finger was covering the flash/flash control sensor. 	<ul style="list-style-type: none"> Move to within the effective flash range before taking the shot. Hold the camera correctly.
The image is blurred.	<ul style="list-style-type: none"> The lens is dirty. The photographed subject was too dark. You photographed scenery with Macro mode selected. You took a close-up shot without selecting Macro mode. You are shooting a subject that is not suited to autofocus. 	<ul style="list-style-type: none"> Clean the lens. Try standing approx. 2 m (6.6 ft.) from your subject to take the picture. Cancel Macro mode. Select Macro mode. Use AF/AE lock to take the shot.

Troubleshooting

► If you think the camera is faulty, check the following once more.

Troubleshooting	Possible causes	Solutions
There is speckling on the image.	The shot was taken with a slow shutter speed (long exposure) in a high-temperature environment.	This is a characteristic of CCDs and does not indicate a camera fault.
Can't format the xD-Picture Card .	The xD-Picture Card contact area is soiled.	Wipe the xD-Picture Card contact area with a clean dry cloth.
Frame erase does not erase the frame.	Some frames may be protected.	Unprotect frames using the camera on which the protection was first applied.
The ERASE ALL function does not erase all the frames.		
Nothing happens when I use the Mode dial.	<ul style="list-style-type: none"> • Camera malfunction. • The batteries run out. 	<ul style="list-style-type: none"> • Briefly remove the batteries or disconnect the AC power adapter. Then reload the batteries or reconnect the AC power adapter and try again. • Fit new or fully charged batteries.
There is no image or sound on the TV.	<ul style="list-style-type: none"> • The A/V cable was connected during movie playback. • The camera is not connected to the TV correctly. • "TV" is selected as the TV input. • The TV volume is turned down. 	<ul style="list-style-type: none"> • Connect the camera and TV correctly. • Connect the camera and TV correctly. • Set the TV input to "VIDEO". • Adjust the volume.
The camera does not emit any sound.	<ul style="list-style-type: none"> • The camera volume is set too low. • The microphone was blocked during shooting/recording. • There is something covering the speaker during playback. 	<ul style="list-style-type: none"> • Adjust the volume. • Take care not to block the microphone during shooting/recording. • Ensure that the speaker is uncovered.
When the camera is connected to a personal computer (PC), the shot image appears on the camera's LCD monitor.	<ul style="list-style-type: none"> • The USB cable (Mini-B) is not correctly connected to the PC or camera. • The PC is not switched on. 	<ul style="list-style-type: none"> • Set up the camera and the USB cable (Mini-B) correctly. • Switch the PC on.
The camera no longer works correctly.	The camera has suffered an unforeseen problem.	Briefly remove the batteries or disconnect the AC power adapter. Then reload the batteries or reconnect the AC power adapter and try again.
The lens does not retract when the camera is switched off.	The camera was switched off too quickly after the power switch was set to photography mode.	Set the power switch to photography mode and wait until the camera is ready to shoot (an image appears on the LCD monitor) before switching the camera off.

Specifications

System

Model	Digital camera FinePix S5000
Number of effective pixels	3.1 million pixels
CCD sensor	1/2.7 inch Super CCD HR in an interwoven pattern Number of total pixels 3.14 million pixels
Number of recorded pixels	Still image : 2816 × 2120 pixels/2048 × 1536 pixels/1600 × 1200 pixels/ 1280 × 960 pixels (BM / BM/2M / 1M) Movie : 320 × 240 pixels (30 frames per second with monaural sound)
Storage media	xD-Picture Card (16/32/64/128/256/512 MB)
File format	Still image : Compressed : JPEG (Exif ver. 2.2) Uncompressed : CCD-RAW (RAF) * Design rule for Camera File System compliant DPOF compatible Movie : AVI format, Motion JPEG Audio : WAVE format, Monaural sound
Lens	Fujinon 10× optical zoom lens Aperture : F2.8 to F8 (Wide-angle) F3.2 to F9 (Telephoto)
Aperture	F2.8 to F8 10 steps in 1/3-EV increments Manual/Auto selectable
Focal length	f=5.7 mm to 57 mm (Equivalent to 37 mm to 370 mm on a 35 mm camera)
Focal range	Normal : Wide-angle : Approx. 0.9 m (3.0 ft.) to infinity Telephoto : Approx. 2.0 m (6.6 ft.) to infinity Macro : Wide-angle : Approx. 0.1 m to 2.0 m (0.3 ft. to 6.6 ft.) Telephoto : Approx. 0.9 m to 2.0 m (3.0 ft. to 6.6 ft.)
Shutter speed	Auto : 2 sec. to 1/2000 sec. Manual : 2 sec. to 1/2000 sec.
Focus	TTL contrast-type, Auto focus, Manual focus
Sensitivity	Manual : Equivalent to ISO200/400/800 (Image quality fixed at 1M for shots taken at ISO 800.) Auto : Equivalent to ISO160-200 (at flash off) Equivalent to ISO200-400 (at flash on)
Photometry	TTL 64-zones metering Multi, Spot, Average
Exposure control	Program AE (Auto , P, SP), Shutter-priority AE, Aperture-priority AE, Manual exposure
Exposure compensation	-2.0 EV to +2.0 EV in 1/3 EV step increments (in Manual mode)
White balance	AUTO (Auto , SP) Manual modes, 7 positions can be selected
Viewfinder	0.33 inches 114,000 pixels electronic viewfinder
LCD monitor	1.5-inches, low-temperature polysilicon TFT 114,000 pixels, 90% coverage
Flash	Auto flash using flash control sensor Effective range : Wide-angle : Approx. 0.3 m to 6.0 m (1.0 ft. to 19.7 ft.) (Approx. 0.3 m to 2.0 m (1.0 ft. to 6.6 ft.) : Macro) Telephoto : Approx. 0.8 m to 5.5 m (2.6 ft. to 18.0 ft.) Flash modes : Auto, Red-eye reduction, Forced flash, Suppressed flash, Slow synchro, Red-eye reduction + Slow synchro
Self-Timer	10 sec.
A/V output	NTSC/PAL selectable

Input/Output Terminals

A/V output socket	2.5 mm dia. jack
USB socket	For file transfer to a computer
DC input	Socket for specified AC power adapter AC-5VH/AC-5VHS (sold separately)

Specifications

Power Supply and Others

Power supply	Use one of the following : <ul style="list-style-type: none"> • 4× AA-size alkaline batteries • 4× AA-size Ni-MH (Nickel-Metal Hydride) batteries (sold separately) • AC Power Adapter AC-5VH/AC-5VHS (sold separately) 									
Guide to the number of available frames for battery operation	<table border="1"> <thead> <tr> <th>Battery Type</th> <th>With LCD monitor ON</th> <th>With viewfinder (EVF) ON</th> </tr> </thead> <tbody> <tr> <td>Alkaline batteries</td> <td>Approx. 260 frames</td> <td>Approx. 270 frames</td> </tr> <tr> <td>Ni-MH batteries 2100 mAh</td> <td>Approx. 420 frames</td> <td>Approx. 440 frames</td> </tr> </tbody> </table>	Battery Type	With LCD monitor ON	With viewfinder (EVF) ON	Alkaline batteries	Approx. 260 frames	Approx. 270 frames	Ni-MH batteries 2100 mAh	Approx. 420 frames	Approx. 440 frames
	Battery Type	With LCD monitor ON	With viewfinder (EVF) ON							
Alkaline batteries	Approx. 260 frames	Approx. 270 frames								
Ni-MH batteries 2100 mAh	Approx. 420 frames	Approx. 440 frames								
	<p>The number of available shots for battery operation given here is a guide to the number of consecutive shots that can be taken under FUJIFILM test conditions.</p> <ul style="list-style-type: none"> • Batteries used : Using the alkaline batteries bundled with the camera Using Ni-MH batteries at full charge • Shooting conditions : Measured at normal temperature with 50% flash use • Note : The number of available shots varies depending on the capacity of the alkaline batteries and the amount of charge in the Ni-MH batteries. Consequently, FUJIFILM makes no guarantee with regard to the numbers of available shots for battery operation given here. Note that the number of available shots will be lower at low temperatures. 									
Conditions for use	Temperature : 0°C to +40°C (+32°F to +104°F) ; 80% humidity or less (no condensation)									
Camera dimensions (W×H×D)	112.7 mm × 81.1 mm × 79.3 mm/4.4 in. × 3.2 in. × 3.1 in. (not including accessories and attachments)									
Camera mass (weight)	Approx. 337 g/11.9 oz. (not including accessories, batteries and xD-Picture Card)									
Weight for photography	Approx. 479 g/16.9 oz. (including batteries and xD-Picture Card)									
Accessories	See P.7									
Optional Accessories	See P.95									

■ Standard number of available frames/recording time per xD-Picture Card

The number of available shots, recording time or file size varies slightly depending on the subjects photographed. Note also that the divergence between standard number of available shots and the actual number of available shots is greater for xD-Picture Cards with higher capacities.

Quality mode	6M	5M	2M	1M	CCD-RAW	Movie 60i
Number of recorded pixels	2816 × 2120	2048 × 1536	1600 × 1200	1280 × 960	2816 × 2120	320 × 240
Image Data Size	1.5 MB	780 KB	630 KB	470 KB	6.7 MB	–
DPC-16 (16 MB)	10	19	25	33	2	26 sec.
DPC-32 (32 MB)	21	40	50	68	4	54 sec.
DPC-64 (64 MB)	43	81	101	137	9	109 sec.
DPC-128 (128 MB)	86	162	204	275	18	219 sec.
DPC-256 (256 MB)	173	325	409	550	37	7.3 min.
DPC-512 (512 MB)	347	651	818	1101	75	14.6 min.

* These specifications are subject to change without notice. FUJIFILM shall not be held liable for damages resulting from errors in this Owner's Manual.

* The LCD monitor on your digital camera is manufactured using advanced high-precision technology. Even so, small bright points and anomalous colors (particularly around text) may appear on the monitor. These are normal display characteristics and do not indicate a fault with the monitor. This phenomenon will not appear on the recorded image.

* The operation error may be caused in a digital camera by the strong radio interference (i. e. electric fields, static electricity, line noise, etc.).

* Due to the nature of the lens, the edges of photographed images may appear distorted. This is normal and does not indicate a fault.

Explanation of Terms

AF/AE Lock :

On the FinePix S5000, pressing the shutter button down half way locks the focus and exposure settings (AF and AE lock). If you want to focus on a subject that is not centered in the frame or change the picture composition after the exposure is set, you can obtain good results by changing the composition after the AF and AE settings are locked.

Auto Power Save Function :

If the camera is not used in any way for 30 seconds, this function switches features such as the monitor off (Sleep mode) to prevent battery depletion and the waste of power when the AC power adapter is connected. If the camera is then left unused for a further period, the Auto Power Save function switches the camera off. This period can be set to 2 minutes or 5 minutes on this camera.

● The Auto Power Off function does not operate in PC mode, during automatic playback, or if it is disabled during setup.

Deactivated batteries :

Leaving a Ni-MH battery unused in storage for a long period may cause a rise in the level of substances that inhibit current flow inside the battery and result in a dormant battery. A battery in this state is referred to as deactivated.

Because current flow is inhibited in a deactivated Ni-MH battery, the battery's original level of performance cannot be achieved.

DPOF :

Digital Print Order Format

DPOF is a format used for recording information on a storage media (image memory card, etc.) that allows you to specify which of the frames shot using a digital camera are to be printed and how many prints are made of each image.

EV :

A number that denotes Exposure Value. The EV is determined by the brightness of the subject and sensitivity (speed) of the film or CCD. The number is larger for bright subjects and smaller for dark subjects. As the brightness of the subject changes, a digital camera maintains the amount of light hitting the CCD at a constant level by adjusting the aperture and shutter speed.

When the amount of light striking the CCD doubles, the EV increases by 1. Likewise, when the light is halved, the EV decreases by 1.

Frame rate (fps) :

The frame rate refers to the number of images (frames) that are photographed or played back per second. For example, when 10 frames are continuously photographed in a 1-second interval, the frame rate is expressed as 10 fps. For reference, TV images are displayed at 30 fps.

JPEG :

Joint Photographics Experts Group

A file format used for compressing and saving color images. The higher the compression rate, the greater the loss of quality in the decompressed (restored) image.

Memory effect :

If a Ni-MH battery is repeatedly charged without first being fully discharged, its performance may drop below its original level. This is referred to as the "memory effect".

Motion JPEG :

A type of AVI (Audio Video Interleave) file format that handles images and sound as a single file. Images in the file are recorded in JPEG format. Motion JPEG can be played back by QuickTime 3.0 or later.

PC Card :

A generic term for cards that meet the PC Card Standard.

PC Card Standard :

A standard for PC cards determined by the PCMCIA.

PCMCIA :

Personal Computer Memory Card International Association (US).

Smear :

A phenomenon specific to CCDs whereby white streaks appear on the image when there is a very strong light source, such as the sun or reflected sunlight, in the photography screen.

WAVE :

A standard format used on Windows systems for saving audio data. WAVE files have the ".WAV" file extension and the data can be saved in either compressed or uncompressed format. Uncompressed recording is used on this camera.

WAVE files can be played back on a personal computer using the following software:

Windows : MediaPlayer

Macintosh : QuickTime Player

* QuickTime 3.0 or later

White Balance :

Whatever the kind of the light, the human eye adapts to it so that a white object still looks white. On the other hand, devices such as digital cameras see a white subject as white by first adjusting the color balance to suit the color of the ambient light around the subject. This adjustment is called matching the white balance. A function that automatically matches the white balance is called an **Automatic White Balance function**.





Exif Print Format is a newly revised digital camera file format that contains a variety of shooting information for optimal printing.

Safety Notes



- To ensure that you use your FinePix S5000 camera correctly, read these Safety Notes and your Owner's Manual carefully beforehand.
- After reading these Safety Notes, store them in a safe place.

About the Icons



The icons shown below are used in this document to indicate the severity of the injury or damage that can result if the information indicated by the icon is ignored and the product is used incorrectly as a result.



	WARNING This icon indicates that death or serious injury can result if the information is ignored.
	CAUTION This icon indicates that personal injury or material damage can result if the information is ignored.

The icons shown below are used to indicate the nature of the information which is to be observed.

-  Triangular icons notify the user of information requiring attention ("Important").
-  Circular icons with a diagonal bar notify the user that the action indicated is prohibited ("Prohibited").
-  Filled circles with an exclamation mark notify the user of an action that must be performed ("Required").

	WARNING	
<p>If a problem arises, switch the camera off, remove the batteries, disconnect and unplug the AC power adapter.</p> <p>Continued use of the camera when it is emitting smoke, is emitting any unusual odor, or is in any other abnormal state can cause a fire or electric shock.</p> <ul style="list-style-type: none"> • Contact your FUJIFILM dealer. 		
<p>Do not allow water or foreign objects to enter the camera.</p> <p>If water or foreign objects get inside the camera, switch the camera off, remove the batteries and disconnect and unplug the AC power adapter. Continued use of the camera can cause a fire or electric shock.</p> <ul style="list-style-type: none"> • Contact your FUJIFILM dealer. 		
<p>Do not use the camera in the bathroom or shower.</p> <p>This can cause a fire or electric shock.</p> <p> Do not use in the bathroom or shower.</p>		
<p>Never attempt to modify or disassemble the camera. (Never open the casing.)</p> <p>Do not use the camera when it has been dropped or the casing is damaged.</p> <p>This can cause a fire or electric shock.</p> <ul style="list-style-type: none"> • Contact your FUJIFILM dealer. <p> Do not disassemble.</p>		
<p>Do not modify, heat or unduly twist or pull the connection cord and do not place heavy objects on the connection cord.</p> <p>These actions could damage the cord and cause a fire or electric shock.</p> <ul style="list-style-type: none"> • If the cord is damaged, contact your FUJIFILM dealer. 		
<p>Do not place the camera on an unstable surface.</p> <p>This can cause the camera to fall or tip over and cause injury.</p>		
<p>Never attempt to take pictures while in motion.</p> <p>Do not use the camera while you are walking or operating a moving car or other vehicle.</p> <p>This can result in you falling down or being involved in a traffic accident.</p>		
<p>Do not touch any metal parts of the camera during a thunderstorm.</p> <p>This can cause an electric shock due to induced current from the lightning discharge.</p>		
<p>Do not use the batteries except as specified.</p> <p>Load the batteries with the poles positioned as indicated by the ⊕ and ⊖ marks.</p>		

	WARNING	
<p>Do not heat, modify or attempt to disassemble the batteries.</p> <p>Do not drop or subject the batteries to impacts.</p> <p>Do not attempt to recharge lithium or alkaline batteries.</p> <p>Do not store the batteries with metallic products.</p> <p>Do not use chargers other than the specified model to charge the batteries.</p> <p>Any of these actions can cause the batteries to burst or leak and cause fire or injury as a result.</p>		
<p>Use only the batteries or AC power adapters specified for use with this camera.</p> <p>Do not use voltages other than the power supply voltage shown.</p> <p>The use of other power sources can cause a fire.</p>		
<p>If the battery leaks and fluid gets into your eyes or comes into contact with your skin or clothing, this can cause injury or loss of eyesight. Immediately flush the affected area thoroughly with clean water and seek medical treatment.</p>		
<p>Do not use the charger to charge batteries other than those specified here.</p> <p>The charger is designed for Fujifilm HR-AA Ni-MH batteries. Using the charger to charge conventional batteries or other types of rechargeable batteries can cause the battery to leak fluid, overheat or burst.</p>		
<p>When discarding or storing batteries, cover the battery terminals with insulation tape.</p> <ul style="list-style-type: none"> • Contact with other metallic objects or batteries could cause the batteries to ignite or burst. 		
<p>Keep xD-Picture Cards out of the reach of small children.</p> <p>Because xD-Picture Cards are small, they can be accidentally swallowed by small children. Be sure to store xD-Picture Cards out of the reach of small children. If a child accidentally swallows an xD-Picture Card, seek medical advice immediately.</p>		

	CAUTION	
<p>Do not use this camera in locations severely affected by oil fumes, steam, humidity or dust.</p> <p>This can cause a fire or electric shock.</p>		
<p>Do not leave this camera in places subject to extremely high temperatures.</p> <p>Do not leave the camera in locations such as a sealed vehicle or in direct sunlight. This can cause a fire.</p>		
<p>Keep out of the reach of small children.</p> <p>This product could cause injury in the hands of a child.</p>		
<p>Do not place heavy objects on the camera.</p> <p>This can cause the heavy object to tip over or fall and cause injury.</p>		
<p>Do not move the camera while the AC power adapter is still connected. Do not pull on the connection cord to disconnect the AC power adapter.</p> <p>This can damage the power cord or cables and cause a fire or electric shock.</p>		
<p>Do not use the AC power adapter when the plug is damaged or the plug socket connection is loose.</p> <p>This could cause a fire or electric shock.</p>		
<p>Do not cover or wrap the camera or the AC power adapter in a cloth or quilt.</p> <p>This can cause heat to build up and distort the casing or cause a fire.</p>		
<p>When you are cleaning the camera or you do not plan to use the camera for an extended period, remove the batteries and disconnect and unplug the AC power adapter.</p> <p>Failure to do so can cause a fire or electric shock.</p>		
<p>When charging ends, unplug the charger from the power socket.</p> <p>Leaving the charger plugged into the power socket can cause a fire.</p>		
<p>Using a flash too close to a person's eyes may temporarily affect the eyesight.</p> <p>Take particular care when photographing infants and young children.</p>		
<p>When an xD-Picture Card is removed, the card may fly completely out of the slot. Use your finger to stop the card from flying out before removing the card.</p> <p>If an xD-Picture Card is allowed to fly out, it could hit someone and cause injury.</p>		
<p>Request regular internal testing and cleaning for your camera.</p> <p>Build-up of dust in your camera can cause a fire or electric shock.</p> <ul style="list-style-type: none"> • Contact your FUJIFILM dealer to request internal cleaning every 2 years. 		



FUJI PHOTO FILM CO., LTD.

26-30, Nishiazabu 2-chome, Minato-ku, Tokyo 106-8620, Japan

<http://home.fujifilm.com/products/digital/>

Printed in Japan



Printed on recycled paper.

FGS-305106-FG