

---

# ALL-IN-WONDER™

# ALL-IN-WONDER PRO™

## Installation and Setup



## User's Guide

Version 1.0

P/N 107-70047-10 Rev. A

© Copyright 1997, by ATI Technologies Inc.

All rights reserved, including those to reproduce this guide or parts thereof, in any form without the express written permission of ATI Technologies Inc.

Features and specifications are subject to change without notice. Trademarks and/or registered trademarks are the properties of their respective owners:

ATI, ALL-IN-WONDER, ALL-IN-WONDER PRO, 3D RAGE, 3D RAGE PRO,  
ATI DeskTop, FlexDesk+, DeskScape, WinSwitch, ImpacTV2, ATI-TV —  
ATI Technologies Inc.; dbx — dbx Professional Products; Pentium, Pentium Pro —  
Intel Corporation; IBM, PC, VGA, OS/2 — International Business Machines Corp.;  
Windows 3.1x, Windows 95, Windows NT, Video for Windows — Microsoft Corp.;  
MultiSync — NEC Technologies Inc.; VESA — Video Electronics Standards Association.

## **Disclaimer**

The manufacturer (MFR) reserves the right to make changes to this document and the products which it describes without notice. The MFR shall not be liable for technical or editorial errors or omissions made herein; nor for incidental or consequential damages resulting from the furnishing, performance, or use of this material.

The MFR makes no representation that the interconnection of products in the manner described herein will not infringe on existing or future patent rights, nor do the descriptions contained herein imply the granting of license to make, use or sell equipment constructed in accordance with this description.

The PCI accelerators have been designed to support the PCI local bus standards. Some computers use proprietary local bus circuitry and therefore may not be fully compatible with the MFR's local bus cards. Although tested successfully in a wide variety of computer systems, the MFR cannot be held responsible for any incompatibilities which may occur between this card and the system configuration you plan to use. We recommend that you check with the dealer or distributor for your computer system before installing your card.

## **Product Notices**

### **Macrovision Corporation**

This device is protected by U.S. Patent numbers 4,631,603,4,577,216, and 4,819,098 and other intellectual property rights.

The use of Macrovision's Copy Protection technology in the device must be authorized by Macrovision and is intended for home and other limited pay-per-view uses only, unless otherwise authorized in writing by Macrovision. Reverse engineering or disassembly is prohibited.

### **Dolby Laboratories, Inc.**

Manufactured under License by Dolby Laboratories. This product contains one or more programs protected under international and U.S. copyright laws as unpublished works. They are confidential and proprietary to Dolby Laboratories Licensing Corporation. Their reproduction or disclosure, in whole or in part, or the production of derivative works therefrom without the express permission of Dolby Laboratories Licensing Corporation is prohibited. Copyright 1992 - 1995 by Dolby Laboratories, Inc. All rights reserved.

---

## CHAPTER 1

# Getting Started

Welcome to the convergence of your PC, TV and video! This new technology changes the way you view TV, graphics, and video on your PC.

ATI's ALL-IN-WONDER and ALL-IN-WONDER PRO are powerful TV, 2D & 3D graphics and video accelerators. Their features will take your PC's graphics and video capabilities to the next level.

This chapter refers to the ATI ALL-IN-WONDER card, but the features described in this chapter apply to the entire ATI ALL-IN-WONDER product family. This guide provides all the information you need to install your ALL-IN-WONDER or ALL-IN-WONDER PRO.



### IN THIS CHAPTER...

- **What is ALL-IN-WONDER?** on page 8
- **System Requirements** on page 10
- **Using this Guide** on page 11
- **Other Sources of Information** on page 12

## What is ALL-IN-WONDER?

ALL-IN-WONDER and ALL-IN-WONDER PRO deliver high-performance 3D and 2D graphics. You can play games, watch TV or videos, listen to audio CDs, explore the Internet, and work in Windows 95 like never before.

ALL-IN-WONDER's advanced 3D acceleration gives you detailed color graphics and 3D features like bi-linear texturing, alpha blending, and fog effects.

ALL-IN-WONDER also provides powerful 2D graphics features through the Display Properties pages:

<b>Settings</b>	Customize your desktop settings such as desktop size, screen resolution and color depth, and store various desktop preferences for easy recall later.
<b>Panning</b>	Set hotkeys to control panning of the desktop within a Virtual Desktop.
<b>Adjustment</b>	Adjust the position and size of your screen, as well as manipulate the screen refresh rate, frequencies and synchronization.
<b>Color Correction</b>	Correct color tone differences between real color values and the way your monitor displays them, and store various color correction preferences for easy recall later.

For comprehensive on-line information on the above features, just right-click on your desktop, click Properties, select the tab you want help for, then click the Help button.

ATI's 3D RAGE accelerator chips provide advanced 3D support and accelerated 2D graphics. Games and software applications that support the 3D RAGE — including Direct3D applications — run with fluid motion and in brilliant color.

	ALL-IN-WONDER	ALL-IN-WONDER PRO (PCI)	ALL-IN-WONDER PRO (AGP)
GRAPHICS ACCELERATOR CHIP	ATI 3D RAGE II	ATI RAGE PRO	ATI RAGE PRO
Gouraud shading	✓	✓	✓
Perspective correction	✓	✓	✓
Alpha blending	✓	✓	✓
Mip mapping	✓	✓	✓
Bilinear filtering	✓	✓	✓
Z-buffering	✓	✓	✓
3D triangle setup engine		✓	✓
dbx <sup>®</sup> TV audio		✓	✓
Accelerated Graphics Port (AGP)			✓

(For explanations of these terms, see the *3-D Graphics Glossary* on page 12.)

ALL-IN-WONDER is a part of ATI's legendary family of graphics accelerators. Your existing 2D games and applications will snap to life with 64-bit acceleration and faster, more vibrant colors.

You can use ALL-IN-WONDER to connect your computer to a television. This feature is ideal for playing games, giving presentations, watching movies, and browsing the Internet. (For more information, see *Using Your ALL-IN-WONDER* on page 29.)

ALL-IN-WONDER also turns your PC into an intelligent TV with the following features:

- Zoom-in
- Scheduled Viewing
- Channel Scanning
- Video capture
- Closed Captioning with “Hot Words” and “Look Back” features
- Program transcript recording
- TV magazine
- Instant Replay (available with ALL-IN-WONDER PRO)

### ALL-IN-WONDER PRO

The ALL-IN-WONDER PRO is the next generation of ALL-IN-WONDER. It provides the following enhancements:

- 3D RAGE PRO accelerator chip
- dbx<sup>®</sup> stereo audio TV
- Up to 8MB of SGRAM memory
- PCI and AGP versions

### System Requirements

- **Computer System** — Pentium<sup>®</sup>/Pentium Pro<sup>®</sup>, Pentium II<sup>®</sup>, or compatible systems with PCI Local Bus or AGP bus
- **Expansion Slot** — 32-bit PCI Local Bus (AGP slot for AGP variants)
- **Operating System** — Windows 95<sup>®</sup>  
*Graphics features only are supported under Windows 3.1x<sup>®</sup>, Windows NT<sup>®</sup> (3.51, 4.0), and OS/2 (2.1, Warp)*
- **Monitor** — VGA, supporting minimum 640x480 resolution. *A Plug-and-Play monitor that supports VESA's Display Channel specifications (DDC1 or DDC2b) is required to take advantage of the DDC1/DDC2b features.*

## Using this Guide

The organization of this guide is as follows:



**Installing the Hardware** on page 17 contains step-by-step instructions to help you place your card in your computer.



**Installing ATI's Enhanced Windows 95 Software** on page 25 describes how to install display driver and ATI Video Player software.



**Using Your ALL-IN-WONDER** on page 29 explains how you can take advantage of the advanced new features of the ALL-IN-WONDER and ALL-IN-WONDER PRO.



**Reference** on page 61 contains troubleshooting tips and specifications about your card.

# Other Sources of Information

If you need additional help or require information that is not included in this guide, see the following sources of information:



### Readme File

This file contains the latest information about your ALL-IN-WONDER card.

#### To view the Readme file in DOS

- 1 Insert the *ATI Installation CD-ROM* into the disk drive.
- 2 In an MS-DOS window, type **D:** (or substitute your CD-ROM drive letter).
- 3 Type **README**.

### Online Help



If you require additional information, you can refer to the online help available under Windows 95 for more information about using ATI's enhanced drivers.



For information on your ALL-IN-WONDER's graphics features, double-click the ATI icon in the lower-right corner of your screen.

## 3-D Graphics Glossary

**Accelerated Graphics Port (AGP).** The AGP bus architecture permits the use of main system memory for 3D display memory requirements, dramatically increasing the number of textures that can be displayed.

**Alpha blending.** Support for true object transparency in hardware. An alpha value defines the transparency of each pixel. The accelerator takes this transparency value into account when drawing objects, perhaps by blurring an object when it passes behind a transparent object or by changing the color of a transparent foreground object to match that of a background object.



**Bilinear filtering.** To interpolate pixels, some low-end 3-D algorithms take the nearest adjacent pixel and replicate its color. Small on-screen movements can cause full pixels to change color, causing aliasing and unwanted screen artifacts. Bilinear filtering averages the 4 nearest texels (textured pixels) to interpolate a pixel, producing a higher-quality image. (In computer graphics, **interpolation** is a method of determining intermediate values between those provided, such as shades of pink along a polygon between vertex colors of white and red.)

**dbx<sup>®</sup>.** System for reducing unwanted hiss and/or distortion. It attenuates loud audio signals that might otherwise become distorted, and amplifies weak audio signals that might be lost.

**Gouraud shading.** A sophisticated shading method capable of producing realistic results. This method applies a lighting model to each vertex of a polygon face, and interpolates the results across the face to achieve a smooth lighting effect.

**MIP mapping.** When a texture is applied to an object, it often must be resized or stretched to fit, which degrades the texture image. MIP mapping creates three or more copies (MIP levels) of the texture, each of a different size, so that the best-fitting copy can be used.

**Perspective correction.** Use of texture maps that continually change to match the viewer's perspective.

**3D Triangle setup engine.** A floating point triangle setup engine provides extremely high frame rates, adding even more detail to complex 3D scenes.

**Z-buffering.** The Z-buffer is the depth buffer, in 3-D graphics. It is used in hidden surface removal algorithms, so that for each pixel written, the depth of that pixel is stored in the Z-buffer. When subsequent objects attempt to draw to that pixel, that object's z value is compared with the number in the Z-buffer, and the write is omitted if the object is farther away from the eye.



---

## CHAPTER 2

# Hardware Installation

Installing your card consists of three, easy steps.

- **Placing the card in your computer**
- **Attaching input and output cables and optional TV, VCR, camcorder, etc.**
- **Installing ATI's enhanced display drivers**

This chapter explains how to place your card in your computer, and describes the input and output cables.



### IN THIS CHAPTER...

- **Preparing Your Computer** on page 16
- **Installing the Hardware** on page 17



Turn off the power to your system, and discharge your body's static electric charge by touching a grounded surface — for example, the metal surface of the power supply — before performing any hardware procedure.

The manufacturer assumes no liability for any damage, caused directly or indirectly, by improper installation of any components by unauthorized service personnel. If you do not feel comfortable performing the installation, consult a qualified computer technician.

Damage to system components, the accelerator card, and injury to yourself may result if power is applied during installation.

## Preparing Your Computer

If you are using an operating system other than Windows 95, you may need to do the following before installing your card:

- If your current system configuration uses special drivers that are not 640x480 VGA, you may encounter conflicts with the card. We recommend that you first reconfigure your operating system to use a **VGA** driver supplied with your operating system before installing the card. For more information about changing your operating system configuration, see your operating system documentation.

## Installing the Hardware

Now that you have prepared your computer, you are ready to install your card.

### To install your card

- 1 Power-off the computer and monitor, then disconnect the monitor cable from the back of your computer.

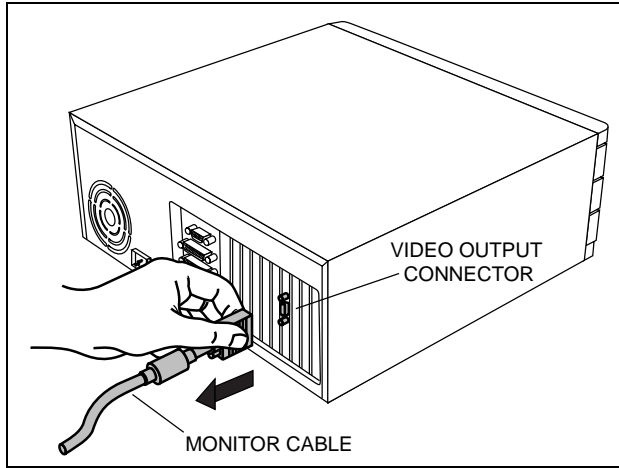

- 2 Remove the computer cover. If necessary, consult your computer system manual about removing the cover.

*Remember to discharge your body's static electricity by touching the metal surface of the computer chassis.*

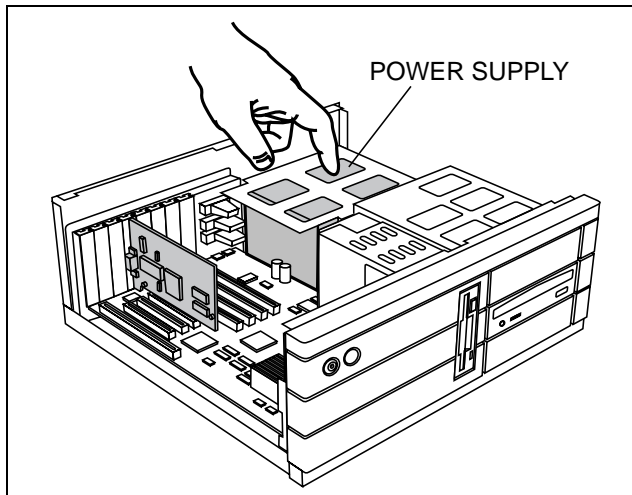

- 3 If there is an existing graphics card, remove it from your computer.

*If the old graphics card sticks, rock it gently from end to end.*

*Remember to save the screw.*

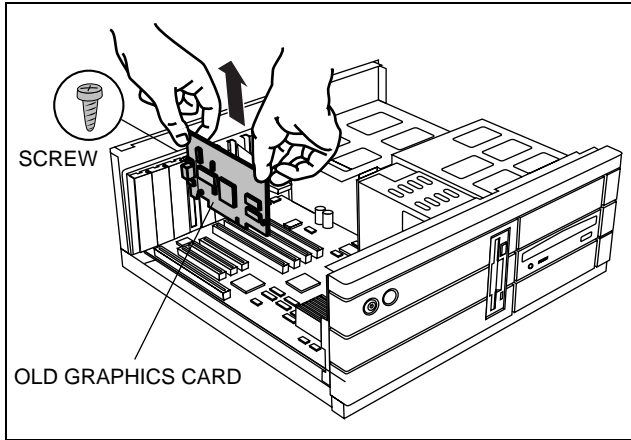

*or*

If your computer has any on-board graphics capability, you may need to disable it on the motherboard. For more information, see your computer documentation.

- 4 Align your card with an empty expansion slot (PCI cards use a PCI slot; AGP cards use an AGP slot) and gently insert it into place. You may need to remove the cover from the rear of the expansion slot that you selected.

*Grasp the card by the top edge and carefully seat it firmly into the correct slot (PCI or AGP).*

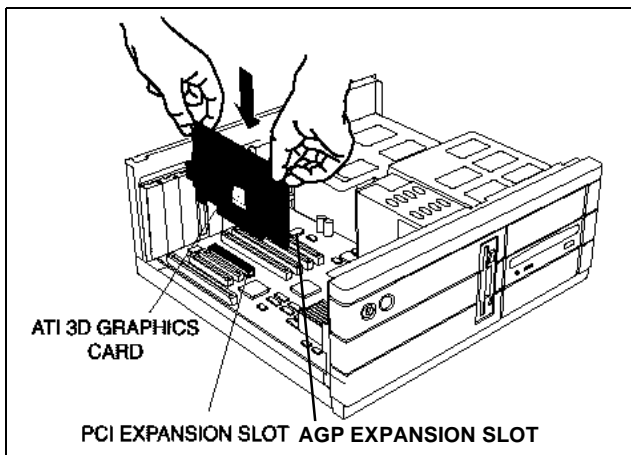

- 5 Replace the screw to fasten the card in place, and replace the computer cover.

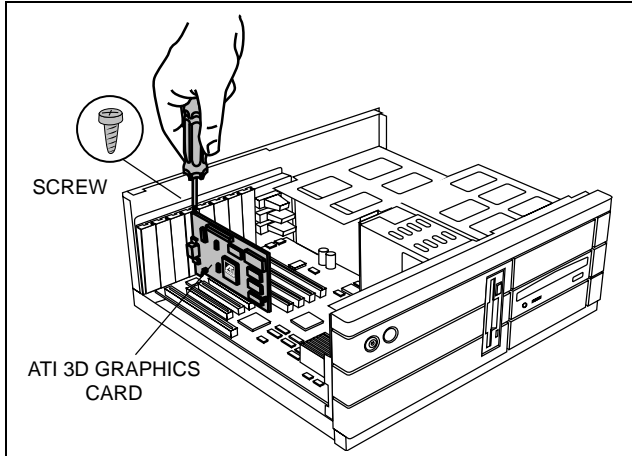

- 6 Plug the monitor into your card, then turn on the computer and monitor.

*Make sure your monitor cable is securely fastened.*

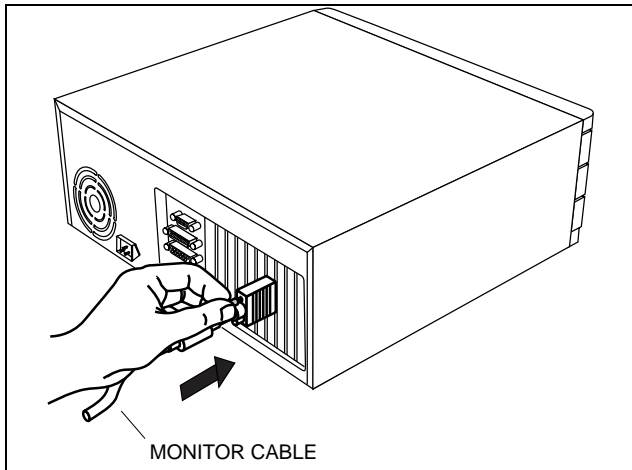

## Input and output adapters

**NOTE**  
To hear audio from the television, you must make a connection between ALL-IN-WONDER and your sound card.

Your ALL-IN-WONDER or ALL-IN-WONDER PRO card uses input and output adapters that let you connect audio and video devices to the card. You can use these adapters to:

- Connect a VCR, laserdisc player, or camcorder, and watch movies on your PC.
- Connect your camcorder and capture video for use in presentations, Web pages, or use third-party videoconferencing software.
- Connect your big-screen TV, and share the PC experience with a group of people, or play games on your big-screen TV.
- Attach a VCR to the video output and record presentations, games, internet, etc.

This illustration shows the audio/video input and output connectors on your **ALL-IN-WONDER** card.

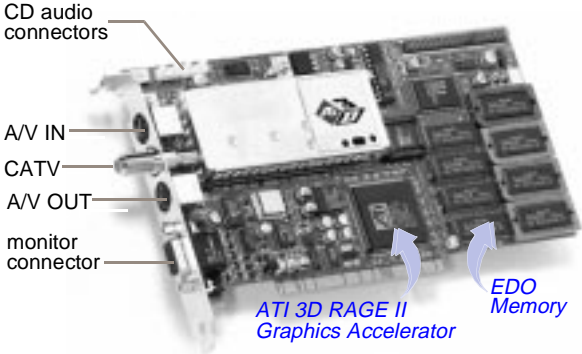

This illustration shows the audio/video input and output connectors on your **ALL-IN-WONDER PRO** card.

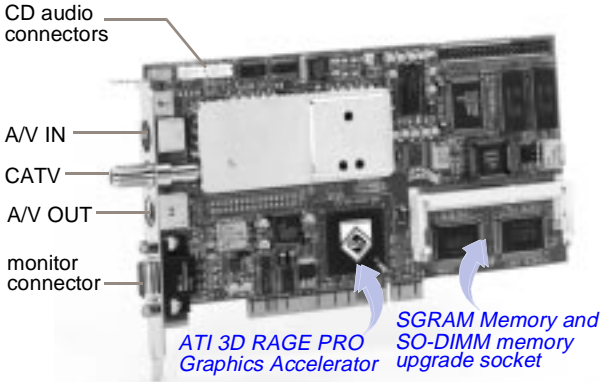



**To watch movies on your PC  
or capture video from your VCR, camcorder, or laserdisc player:**

Use the 4-headed input adapter to connect a VCR, camcorder, or laserdisc player to your ALL-IN-WONDER card, as shown.



The audio and video **output** connectors on your VCR, camcorder, or laserdisc player will be similar to these. Use **COMPOSITE VIDEO OUT** **or** **S-VIDEO OUT**. S-Video will provide better results.

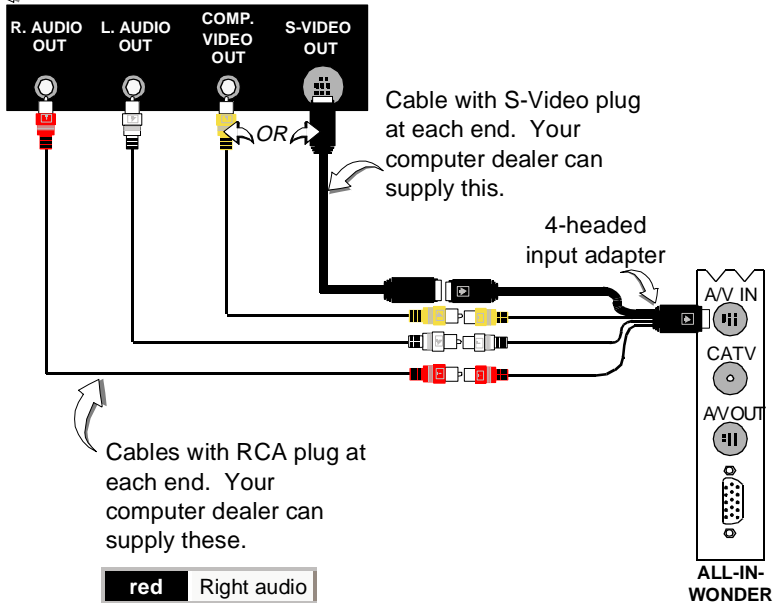

**To display your PC output on TV  
and record your PC output on videotape:**

Use the 3-headed output adapter to connect a TV, camcorder, or VCR to your ALL-IN-WONDER card, as shown.



The audio and video **input** connectors on your TV, camcorder, or laserdisc player will be similar to these. Use COMPOSITE VIDEO IN or S-VIDEO IN. S-Video will provide better results.



Cable with S-Video plug at each end. Your computer dealer can supply this.

Cable with RCA plug at each end. Your computer dealer can supply this.

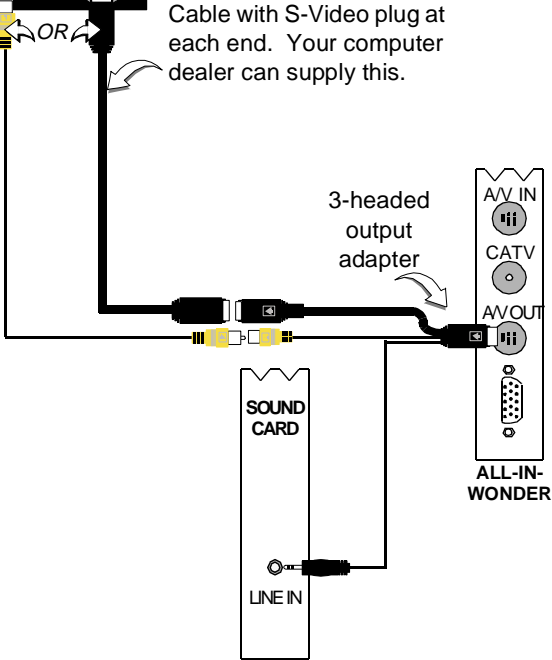

## Win95 volume control

For correct audio performance, your sound card's line input must be active. To display the Line Input setting in the Windows 95 Volume Control panel:

- 1 Right-click the speaker icon  in the Taskbar (usually in the lower-right corner of your screen).
- 2 Click Open Volume Controls.
- 3 If the Line-In volume slider is not visible, click Options, then click Properties.
- 4 Click the Line-In volume control checkbox, then click OK.
  - If the Mute checkbox is checked, click it to cancel muting.

### To select the sound card connector for TV audio input

The sound card connector determines which mixer slider is controlled by the ATI VIDEO PLAYER's volume slider.

- 1 Click the Setup button  in the TV Tuner control panel.
- 2 Click the Video tab.
- 3 Click the Audio Input list box.
- 4 Select a sound card connector from the drop-down list.

Line-In
MIDI
CD Audio
Line-In
Wave

## Video tips

- In the TV Tuner tab, ensure that you click the **correct setting for cable or antenna**.
- For the best indoor antenna reception, use an **amplified** model, and move it as **far away from your monitor** as possible.



---

## CHAPTER 3

# Installing ATI's Enhanced Windows 95 Software

ALL-IN-WONDER and ALL-IN-WONDER PRO are designed to function fully under Windows 95. When running under other operating systems, they operate as graphics cards only.

Your computer uses programs called graphics drivers to display information on the screen. ATI's enhanced drivers give you enhanced speed, resolution, color depth, graphic utilities, and 3D features.

In addition, the ATI VIDEO PLAYER program completes the functionality of ALL-IN-WONDER.

This chapter explains how you install ATI's enhanced software.



### IN THIS CHAPTER...

- **Installing Windows 95 Enhanced Drivers** on page 26
- **Installing ATI VIDEO PLAYER for Windows 95** on page 27
- **Using VESA BIOS Extensions for DOS Gaming** on page 28

## Installing Windows 95 Enhanced Drivers

You need to install ATI's enhanced driver for Windows 95 to take advantage of your card's higher performance, resolutions, and special features.



When you restart your system following installation of your ALL-IN-WONDER card, Windows 95 will detect the new hardware and may attempt to install a driver from its system registry. When prompted to "Restart the computer now", select **NO**. Then follow the normal installation procedure below.

Selecting 'NO' for the initial restart prompt is a necessary step since Windows 95 may load an older display driver that is incompatible with your new graphics card. Always use the driver available on the ATI Installation CD-ROM, or an applicable driver update.

Always use the **latest version** of the ATI Installation CD-ROM to install ATI display drivers and multimedia software. The last three digits of the CD part number represent the version — a higher number indicates a later version.

All ATI Installation CD-ROMs include a complete set of display drivers and multimedia software.

Use the **same** ATI Installation CD-ROM to install the ATI enhanced display driver and the ATI VIDEO PLAYER.

### To install the ATI RAGE family enhanced driver for Windows 95

- 1 Insert ATI's Installation CD-ROM into your CD-ROM drive.  
*If Windows 95 runs the ATI INSTALLATION CD-ROM automatically, proceed to step 5.*
- 2 Click Start.
- 3 Click Run.
- 4 Type the following:  
**D:\ATISSETUP**  
(If **D** is not your CD-ROM drive, substitute the correct drive letter.)
- 5 Click on Display Drivers.
- 6 Follow the on-screen instructions to complete the installation.

## Installing ATI VIDEO PLAYER for Windows 95

Now that you have installed ATI's enhanced driver for Windows 95, you can install the ATI VIDEO PLAYER.

**You must install ATI's enhanced driver before installing the ATI VIDEO PLAYER.** The ATI VIDEO PLAYER must be installed to enable all features of the ALL-IN-WONDER.

### To install the ATI VIDEO PLAYER for Windows 95

- 1 Insert ATI's Installation CD-ROM into your CD-ROM drive.  
*If Windows 95 runs the ATI INSTALLATION CD-ROM automatically, proceed to step 5.*
- 2 Click the Start button.
- 3 Select Run.
- 4 Type the following:  
**D:\ATISSETUP**  
(If **D** is not your CD-ROM drive, substitute the correct drive letter.)
- 5 Click ATI VIDEO PLAYER.
- 6 Follow the on-screen instructions to complete the installation.

### To open the ATI VIDEO PLAYER for Windows 95

- 1 Click the Start button.
- 2 Click Programs.
- 3 Click ATI Multimedia.
- 4 Click ATI VIDEO PLAYER.

For information on the ATI VIDEO PLAYER, see the online help.

## Using VESA BIOS Extensions for DOS Gaming

The VESA BIOS Extensions (VBE) feature supports software using modes compatible with VESA standards.

To ensure that VBE works correctly, you can load a DOS TSR (terminate-and-stay-resident) program called M64VBE. If your software and/or games conform to the VBE standard, you should load M64VBE first.

### To install the M64VBE.COM program

- 1 Restart your computer in MS-DOS mode.
- 2 Insert ATI's Installation CD-ROM into your CD-ROM drive.
- 3 Type **D:** (If **D** is not your CD-ROM drive, substitute the correct drive letter).
- 4 Type **CD UTILITY**.
- 5 Type **INSTALL**.
- 6 Select Utilities Installation from the Main Menu.
- 7 Press ENTER to select the default destination directory.
- 8 When prompted, let the INSTALL program make changes to your Autoexec.bat file.
- 9 Press ESC to exit the INSTALL program.
- 10 Restart your computer.

*You are now ready to load M64VBE.*

### To load M64VBE

In MS-DOS mode, at the command prompt, type **M64VBE**.

### To remove M64VBE from your system

- 1 Restart your computer in MS-DOS mode.
- 2 At the command prompt, type **M64VBE U**.
  - For more information, see your DOS documentation for conditions on unloading TSRs.



---

## CHAPTER 4

# Using Your ALL-IN-WONDER

You can take advantage of the special features that your ALL-IN-WONDER has to offer. This chapter refers to the ATI ALL-IN-WONDER card, but all features described in this chapter (except Instant Replay, Secondary Audio Program, and dbx<sup>®</sup> TV stereo, which are available only with ALL-IN-WONDER PRO) apply to the entire ATI ALL-IN-WONDER product family.

Because North American and European television use different broadcast standards, closed-captioning and related features are available only in North America, and Teletext is available only in Europe.



### IN THIS CHAPTER...

- **Using ATI VIDEO PLAYER** on page 30
- **Playing Media Files** on page 36
- **Playing Audio CDs** on page 37
- **Capturing Video and Audio** on page 39
- **Teletext** on page 42
- **Intelligent TV Tuner** on page 43
- **Attaching Your TV to the ALL-IN-WONDER card** on page 55
- **Setting up ATI VIDEO PLAYER** on page 57

## Using ATI VIDEO PLAYER

### In Windows 95

- 1 Click **Start**.
- 2 Select **Programs**.
- 3 Select **ATI Multimedia**.
- 4 Click the **ATI PLAYER**.

*For information about using the ATI VIDEO PLAYER controls, see the online help.*

### The Task control panel

The Task control panel indicates what mode the player is in and what it's doing. (Your Task control panel may not look exactly like the illustration—only installed or available features have controls.)

Context-sensitive help is always available when you press the F1 key. All control panels provide bubble help; just point your mouse at a control to see a pop-up description of its function.



*Instantly select the function you want –  
the Task control panel shows you what's happening.*

## Switching modes

Use the Task control panel buttons to switch between Media Playback, Audio CD, TV, Capture, and Teletext mode.



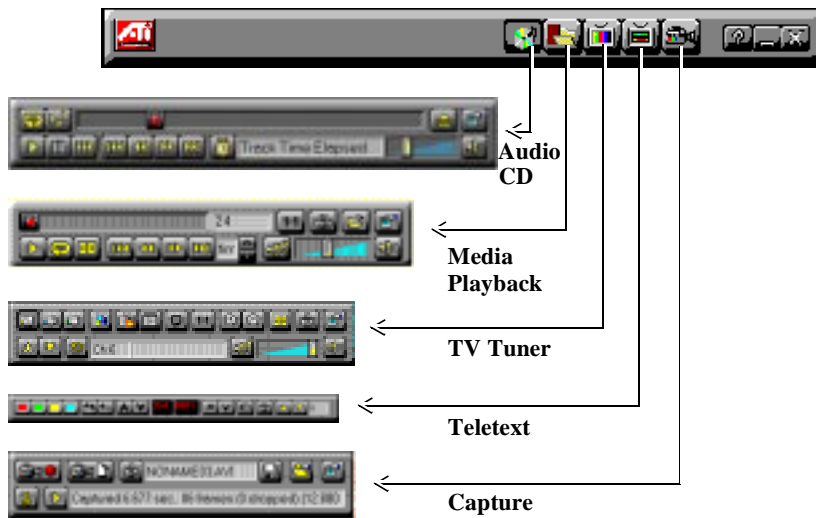

	<b>Media Playback</b>	Play MPEG and AVI video files.	See <i>Playing Media Files</i> on page 36.
	<b>Audio CD</b>	Play standard audio CDs.	See <i>Playing Audio CDs</i> on page 37.
	<b>TV</b>	Display live video sources, such as television programs.	See <i>Intelligent TV Tuner</i> on page 43.
	<b>Capture</b>	Capture still images, video sequences, or audio-only.	See <i>Capturing Video and Audio</i> on page 39
	<b>Teletext</b>	Display and navigate European Teletext, including FasText.	See <i>Teletext</i> on page 42

## ALL-IN-WONDER — The Control Panels

When you select a mode in the Task control panel or press a shortcut key, the Control panel changes to the appropriate control panel for that mode. All modes provide context-sensitive help; see *Online Help* on page 35.



You can also use the following shortcut keys to start playback, TV tuner, capture, CD audio, or Teletext.

	Media Playback	Press F5
	TV Tuner	Press F6
	Capture	Press F8
	CD Audio	Press F4
	Teletext	Press F7

## Controlling the audio volume

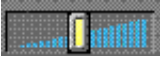

The TV Tuner, Audio CD, and Media Playback panels have a volume control slider. Use the mouse to move the slider to increase and decrease the audio volume. You can choose from a drop-down list to specify which audio mixer slider to control.

## Muting the audio volume



The TV Tuner, Audio CD, and Media Playback panels have a Mute button that you can click to temporarily turn off the audio. Clicking the button again or moving the volume control slider cancels muting.

## The Display Panel

The Display panel is the “screen” where your media plays. It’s a familiar, TV-style display that you can resize, place on top of other windows, and position automatically in one of nine locations on the screen.

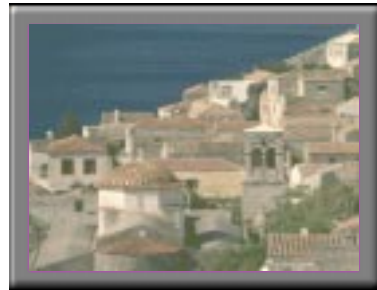

The F2 key hides/shows the control panel, to save desktop space.



*Move the Display panel, zoom it to full-screen, and minimize it as an icon.*

## Sizing the Display panel

You can resize the Display panel using the mouse, the Control panel buttons, or CTRL key combination:

	Increase size of Display Panel	CTRL + Up Arrow
	Decrease size of Display Panel	CTRL + Down Arrow
	Play full-screen	CTRL + F

In **TV mode**, when you play full-screen video, the Playback panel becomes “thin”. To show/hide the thin Playback panel, press F2.

You can also use the CTRL key to display these preset sizes:

160x120 pixels.	CTRL+1
240x180 pixels.	CTRL+2
320x240 pixels.	CTRL+3
640x480 pixels.	CTRL+4
Toggle between full screen and current size.	CTRL+F ALT+F

## Attaching and Detaching Panels

You can detach ALL-IN-WONDER control panels from the Display panel, move them to any location on your screen, and re-attach them. Panels attached to the Display panel share the Display panel's **snap window to:** and **always on top** settings (For more information, see *Display* in *Setting up ATI VIDEO PLAYER* on page 57).

When you display closed-captioned text in a window, you can attach and detach the closed-captioned window.

### To detach a panel

**While holding down the Shift key, click** the panel where the panel edges meet, then **drag** it away.

### To attach a panel

**Drag** it near the Display panel until its outline changes, then **release** the mouse button. The panels will snap back together.

## Online Help



**ATI Player Help.** Click the Help button at any time to open the online help.

F1

**Context-Sensitive Help.** Context-sensitive help is always available in each panel. Just press the F1 key.



**Bubble Help.** Simply move the mouse cursor over a control to see a description of its purpose. As you become familiar with ALL-IN-WONDER, you may want to turn off help — click the **Show Bubble Help** checkbox in the **Display** configuration dialog (for more information, see *Display* in *Setting up ATI VIDEO PLAYER* on page 57).



**ATI Desktop Help.** For help on your ALL-IN-WONDER's graphics features, double-click the ATI icon in the lower-right corner of your screen.

## Playing Media Files

Click the Media Playback button in the Task control panel to switch to playback mode.



The Control panel changes to the Playback panel.



To view / hide the Playback panel, press F2.



*Context-sensitive help is always available when you press the F1 key.*

*All controls provide bubble help; move the mouse cursor over a control to see a pop-up description of its function.*

You can use the Media Playback panel to play the following media files:

- MPEG-1 digital audio and video
- MPEG-1 Video CD 2.0 Interactive CDs
- Karaoke CDs
- .AVI video files

### To play a file

- 1 In the Playback panel, click the File Open button. 
- 2 Select a file from the list.
- 3 Click Add, then click OK.
- 4 Click the Play button. 

The file plays in the Display panel.

*For more information on using the Playback panel controls and features, see the on-line help.*



## Playing interactive discs (Video CD 2.0)

When playing Video CD 2.0 discs, the Control panel changes to this interactive panel.



*Context-sensitive help is always available when you press the F1 key.*

*All controls provide bubble help; move the mouse cursor over a control to see a pop-up description of its function.*

## Playing Audio CDs

Click the Audio CD button in the Task control panel to switch to Audio CD mode.



*The Control panel changes to the Audio CD control panel.*

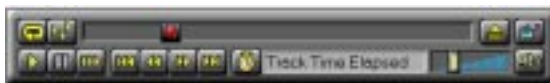



Use the Audio CD panel to play standard audio CDs. Advanced features such as Random play, Intro play, which plays the first ten seconds of each track, and Loop play are available.



*The Audio CD player has its own display window.*

### To play an audio CD

- 1 Insert the audio CD into your CD-ROM drive.
- 2 In the Audio CD panel, click the Setup Dialogs button. 
- 3 Click the Disc Info tab.
- 4 From the Available Tracks list, add or remove tracks as desired. The Play List displays your current selections.
- 5 Click OK.
- 6 In the Audio CD panel, click the Play button. 

The Audio CD player uses Windows 95's standard INI file to store disc names, track names, and the play list. You can use the Setup dialog to enter the name of the artist and the disc.

*For more information on using the Audio CD controls and features, see the on-line help.*

## Capturing Video and Audio

**Still images.** You can capture full-color, 24-bit-per-pixel still images from your camcorder or television, save them on your computer's hard disk, and print them. The images are placed on the clipboard, or you can display them in their own window as "thumbnails" (miniature images).

ALL-IN-WONDER saves still images as Windows-standard bitmaps (.bmp). It also supports most industry-standard graphics file formats, so you can insert the images into reports, presentations, letters, and other documents, to add impact to training applications and presentations.

**Full-motion video.** You can capture a stream of full-motion video plus audio from your video source and save it as an .AVI file on your computer's hard disk. You also have the option of capturing only audio — uncheck the **Capture Video** box in the **Capture** dialog (see *Capture* in *Setting up ATI VIDEO PLAYER* on page 57.)

Click the Capture button in the Task control panel to switch to capture mode.



*The Control panel changes to the Capture panel.*

Use the **Save As...** button to compress your captured video and save it in one of several industry-standard formats. See the on-line help for more information on this feature.

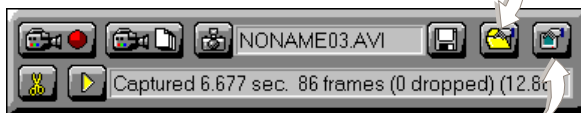

Use the **Setup** button to specify capture options, file names, display options, and file handling for captured video (see *Capture* in *Setting up ATI VIDEO PLAYER* on page 57.)

*Context-sensitive help is always available when you press the F1 key.*

*All controls provide bubble help; move the mouse cursor over a control to see a pop-up description of its function.*

## Capturing still frames

For information on setting up capture files, see *Still Capture* in *Setting up ATI VIDEO PLAYER* on page 57.

### To capture still frames

Click the camera button  to capture the current frame.

### To review captured images

Click the image's thumbnail.

- If the selected image has **not** been saved, the thumbnail has a red border. If it **has** been saved, the border is green.
- If an unselected image **has** been saved, its border is grey. If it has **not** been saved, there is no border.

You can use the buttons at the top of the still capture window to **save** the captured image, **delete** it, **print** it, or make it into a **desktop pattern**.

If you try to delete an unsaved still frame, the system prompts you to save it before deleting.

## Capturing video

You can capture video in two ways:

- As a **stream of video and audio** that you save as an .AVI file.
- As a **sequence of still frames** that you save in an .AVI file.

The quality of the video that you capture depends on the following conditions:

- speed of your system (CPU)
- amount of system memory (RAM)
- performance of your hard disk
- size of the video capture window

For information on setting up capture files, see *Capture* and *Advanced* in *Setting up ATI VIDEO PLAYER* on page 57.

**To capture a stream of video and audio**

Click the Record Video button  in the Capture panel.  
ALL-IN-WONDER starts recording video and audio.

**NOTE**  
Audio is  
not  
captured  
in this  
mode.

**To capture a sequence of frames**

Click the Capture Sequence button  in the Capture panel.

ALL-IN-WONDER starts recording a sequence of frames.

## Playing Captured Video and Audio

**To play captured video and audio**

Click the Play button  in the Capture panel.  
ALL-IN-WONDER plays your captured file.

## Editing Captured Video and Audio

The video editing feature lets you mark start and end points in a captured clip, and save only the portion that you select.

Click the Frame Edit button in the Capture control panel to switch to editing mode.

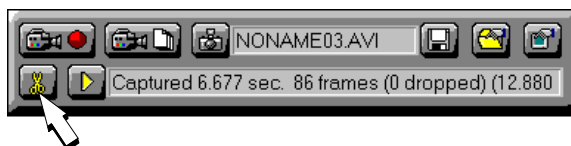

The Capture control panel changes to the Editing panel.



*Context-sensitive help is always available when you press the F1 key.*

*All controls provide bubble help; move the mouse cursor over a control to see a pop-up description of its function.*

## Teletext

**European feature**

ATI VIDEO PLAYER supports European Teletext, including FasText. Use the Teletext controls to move through major pages and sub-pages, and randomly select pages. Text is displayed in the Display panel.

If you are using a third-party Teletext application, the closed-caption button  in the TV Tuner control panel is replaced by a button that launches your Teletext application.



Click the Teletext button in the Task control panel to switch to Teletext mode.



*The Control panel changes to the Teletext panel.*



*Context-sensitive help is always available when you press the F1 key.*

*All controls provide bubble help; move the mouse cursor over a control to see a pop-up description of its function.*

## MediaNet

TV-Online from MediaNet is an enhanced teletext program that can be launched directly from your ATI-TV. After installing the software, you can launch TV-Online by clicking on the teletext icon in the TV Tuner panel.

## Intelligent TV Tuner

Now you can watch TV, videos, or games on your computer!

ALL-IN-WONDER lets you watch up to 125 cable television channels and 70 antenna channels in smooth, full-motion video on the whole screen or in a window.

Capture still frames and movie clips, channel surf, and create your own TV transcripts.



*Get real-time information when you want it. Move the TV window, zoom it to full-screen, and capture video.*

## Features

- Television-quality video in a window and full screen. ALL-IN-WONDER PRO provides dbx<sup>®</sup> stereo TV audio.
- **Composite Video and S-Video inputs** for VCR, video camera, laser-disc player, video game consoles, etc.
- **Capture Video and Audio** with a simple mouse click.
- **Live Motion Video Desktop**, using your favorite TV show as wallpaper.
- **Channel Scan** through all available stations in seconds.
- **Zoom-In** to any part of the screen.
- **Closed Captioning** support (NTSC only), including **Transcript Creation** and **Hot Words** that alert you when ALL-IN-WONDER is receiving information you want to watch.
- **Visual Channel Selection** — select channels by clicking on “thumbnail” images of the channels.
- **Scheduled Viewing** — play particular files and/or watch selected TV channels at times you specify.
- **TV Magazine** — transcribe closed-captioned broadcasting and remove advertisements, including pictures and text.
- **Instant Replay** — ALL-IN-WONDER PRO can replay live video, with a 2 to 10 second delay, while you watch TV.
- **Channel Lockout** and **Program Lockout** for parental control.
- **Secondary Audio Program (ALL-IN-WONDER PRO).**

## Using the TV Tuner

The TV Tuner displays cable or broadcast television and smooth, full-motion video on the whole screen or in a window. You can use the TV Tuner to:

- Watch television on your computer as you work in another software application.
- Watch a videotape or laser disk movie on your computer.
- Capture, save, and print TV and video images.
- Display and record closed-captioned text.
- Replace your desktop with live TV display.

ALL-IN-WONDER accepts a wide range of video inputs: TV antenna or cable, VCR, Video camera, laser disk, and video games.

Click the TV Tuner button in the Task control panel to switch to TV mode.



The Control panel changes to the TV control panel (in this illustration, CATV is selected).



You can use the **Setup** button to adjust color, select the broadcast standard, add and delete channels, and set closed-caption options (see *Video, Tuner, and Closed Caption* in *Setting up ATI VIDEO PLAYER* on page 57.) Or press TAB and use the cursor keys to adjust the picture on-screen, just like a TV.

*Context-sensitive help is always available when you press the F1 key.*

*All controls provide bubble help; move the mouse cursor over a control to see a pop-up description of its function.*

### To select the sound card connector for TV audio input

- 1 Click the Setup button  in the TV Tuner control panel.
- 2 Click the Video tab.
- 3 Click the Audio Input list box.
- 4 Select a sound card connector from the drop-down list.

Line-In
MIDI
CD Audio
Line-In
Wave



## Validating TV channels

When you click the **Auto Scan** button in the Tuner setup dialog (see *Tuner* in *Setting up ATI VIDEO PLAYER* on page 57), the TV Tuner scans for all available channels and stores them. When scanning is complete, you can type in a name for each channel. Before scanning, use the drop-down list box to select the broadcast format and the cable standard.

If you want to change channel assignments, you can use the slider that appears at the top of the dialog. For example, you could assign the actual channel 5 to the ALL-IN-WONDER's channel 2.

- Double-clicking the slider returns the current channel's assignment to normal; for example, selecting channel 2 tunes in channel 2.
- Clicking the **Auto Scan** button returns all the channel assignments to normal.

## Zooming and unzooming

Select and enlarge a portion of the display by dragging the mouse across the Display Panel

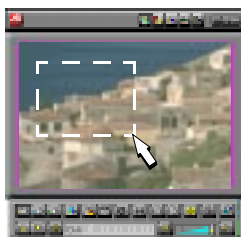

### To select and enlarge a portion of the display

- 1 Click within the display panel.
- 2 Hold down the mouse button and draw a rectangle around the area you want to zoom.

To return your display to normal, click the **Unzoom** button  in the Control panel.

## Hot Words

**North  
American  
feature**

Have your computer watch TV for you! When you turn on Closed Captioning, you can specify words and phrases that ALL-IN-WONDER will detect in the closed-captioned text. You set Hot Words to begin transcribing the text or to maximize the TV Tuner when the Hot Words appear.

You specify words using the Hot Words configuration dialog. (see *Hot Words* in *Setting up ATI VIDEO PLAYER* on page 57).

### To select Hot Words

- 1 Click the Setup button  in TV Tuner mode.
- 2 Click the Hot Words tab.
- 3 Type in the Hot Words that you want.
- 4 Choose the type of match you want:
  - **Always** Takes effect when the Hot Word occurs.
  - **With** Takes effect when the Hot Word occurs, and is immediately followed by a Second Word.
  - **Without** Takes effect when the Hot Word occurs, if it is not immediately followed by a Second Word.
  - **Within** Takes effect when the Hot Word occurs, if it is within a definable number of words of a Second Word.
- 5 Type in a Second Word where required, then click Add.
- 6 To allow the ALL-IN-WONDER to maximize from a minimized state, click the **Enable Hot Words** box.
- 7 To enable the Hot Word to trigger transcription, click the **Enable Transcribing on match** box.

### To enable/disable specific Hot Words

Select the Hot Word from the list and click the Enable/Disable button

- + appears before enabled Hot Words
- appears before disabled Hot Words

The Closed Caption button  in the TV Tuner panel must be enabled for Hot Words to function.

## Channel Lockout

Channel Lockout prevents anyone without the correct password from viewing selected TV channels. The first time you lock out a channel, a Channel lockout dialog prompts you for a four-character password.

**If you forget your password, you must uninstall and re-install your ALL-IN-WONDER software to view password-protected channels.**

### To lock out a channel

- 1 Click the Setup button  in TV Tuner mode.
- 2 Click the TV Tuner tab.
- 3 Select the channel you want to lock out, and click the box to the right of the channel name.
- 4 Type in a four-character password.
- 5 Retype the password.

*The box to the right of the channel name turns into a padlock.*

- 6 Click OK.
- The channel up and channel down buttons in the TV Tuner panel skip locked-out channels. The only way to select a locked-out channel is to enter the channel name or number, and type the password when prompted.
  - When a password is active, you will be prompted to enter it when you select the TV Tuner dialog. If you do not enter the password, the TV Tuner dialog will open, but all controls will be disabled; this prevents anyone from changing tuner settings if they do not have the correct password.

### To unlock a channel

- 1 Click the Setup button  in TV Tuner mode.
- 2 Click the TV Tuner tab.
- 3 Type in your four-character password.
- 4 Select the channel you want to unlock, and click the padlock to the right of the channel name.

## Program Lockout

When you use the TV Tuner, Program Lockout lets you block particular programs at specific times, and set a password to unlock them. Use the Program Lockout Dialog to specify programs, times, and duration.

**If you forget your password, you must uninstall and re-install your ALL-IN-WONDER software to view password-protected programs.**

### To lock out a program

- 1 Click the Setup button  in TV Tuner mode.
- 2 Click the TV Tuner tab.
- 3 Select the program you want to lock out, and click the box to the right of the channel name.
- 4 Type in a password.
- 5 Retype the password.
- 6 Click OK.

## Video Desktop

### To replace your desktop pattern with live TV display when you minimize the ATI Video Player

- 1 Click the Setup button .
- 2 Click the **Video Desktop** checkbox in the **Display** configuration dialog (see *Display* in *Setting up ATI VIDEO PLAYER* on page 57).
- 3 Minimize the Player.

A Player icon appears in the Taskbar. Click the icon to display a small control panel that you can use to change channels and control the volume.

## Displaying closed-captioned text

### North American feature

You can display closed-captioned text that is broadcast with NTSC television programming. ALL-IN-WONDER also displays closed-captioned text in NTSC videotapes that contain closed-captioned material.

- In full-screen, the text overlays the video, as in standard TV.
- When you play video in a window, you can optionally display the text in a separate window.

### To display closed-captioned text

Click the Closed Caption button  in the TV Tuner panel.

### To display the text overlaid on the video

- 1 Click the Setup button .
- 2 Click the **Display over video** checkbox in the **Closed Caption** configuration dialog (see *Closed Caption* in *Setting up ATI VIDEO PLAYER* on page 57).

### To create a closed-captioned transcript

Click the **Create Transcript in File...** checkbox in the **Closed Caption** configuration dialog (see *Closed Caption* in *Setting up ATI VIDEO PLAYER* on page 57).

## Visual Channel Selection

You can browse through several TV channels simultaneously, and select channels by clicking on “thumbnail” images (miniature representations) of the channels. Each thumbnail displays the channel number, and is regularly updated to display the current program.

- If any channel in the selection list is a locked-out channel, a password is required to access it. If a password is not entered, only unlocked channels are displayed.
- After an autoscans, all detected channels are included in the selection list. A magnifying glass appears to the left of the lock-out icon. Click the magnifying glass button to add or remove the channel from the selection list.
- Most controls are disabled during Visual Channel Selection.

### To use Visual Channel Selection

- 1 Click the magnifying glass button  in the TV Tuner control panel.  
A grid of thumbnails appears over your TV display.
- 2 Click the thumbnail for the channel you want to preview.  
The channel you clicked becomes “live”, and plays video and audio for a few seconds.
- 3 To select a channel for viewing, double-click a thumbnail.  
The grid of thumbnails disappears, and the selected channel appears on your screen.

## Scheduled Viewing

Scheduled viewing lets you set up the ATI VIDEO PLAYER to play particular files and/or watch selected TV channels at times you specify.

You can run the scheduler immediately, and/or install the scheduler in your Windows Startup file, so that it runs every time Windows is started. A warning is displayed whenever you click OK after adding an item to the scheduled viewing list.

### To use Scheduled Viewing

- 1 Click the Setup button  in TV Tuner mode.
- 2 Click the Schedule tab.
- 3 Fill in the events and times you want to schedule.
  - Events whose date (On Month & Day) has passed are not automatically removed. To re-activate an event, set its Month & Day to today or later.
  - If the Player setup dialog is open, or if the About Help... box is being displayed, the Player cannot process events. If an event occurs, a warning notifies you that a particular event was not processed.
  - When the Player first runs, if there are any scheduled events recorded and the scheduler program is not running, a warning tells you that the scheduled events will not be processed.

## TV Magazine

**North  
American  
feature**

When you use the TV Tuner, TV Magazine lets you transcribe closed-captioned broadcasting, including pictures and text. Files are saved in RTF (Rich Text Format), which preserves formatting and can be used in many word processors.

### To use TV Magazine

- 1 Click the Setup button  in TV Tuner mode.
- 2 Click the TV Magazine tab.
- 3 Click Enable TV Magazine in the TV Magazine dialog.
- 4 Click the settings you want.

<b>Image Layout</b>	Lets you save transcripts in four text and picture layouts.
<b>Automatic case conversion</b>	Converts all characters to upper- or lower-case.
<b>Black &amp; White pictures</b>	Saves images as black & white only, to conserve disk space.
<b>Picture rate</b>	Specifies the number of lines of captioning per picture.
<b>Remove advertisements</b>	<p>Automatically skips commercial advertising when you display or transcribe closed-captioned text. It works best with programs that use scrolling transcripts rather than “text bubbles” to record closed-captioned text; for example: Talk shows, News broadcasts, Sports, and Soap operas.</p> <p>(Depending upon the closed-captioning format, commercials may occasionally be recorded—a little experimentation will show you how to get the best results.)</p>



## Instant Replay

ALL-IN-  
WONDER  
PRO

Instant Replay lets you replay live video, with a 2-to-10-second delay, while you watch TV. (Instant Replay is only available with ALL-IN-WONDER PRO.)

### To start Instant Replay

Click the Start Instant Replay button  in the TV Tuner control panel.

### To display the Instant Replay panel

Click the Show Instant Replay button  in the TV Tuner control panel.

The Instant Replay panel opens beside the Display panel, and plays the recorded video with the delay you specify.

Move the delay slider left to decrease delay time to a minimum of 2 seconds.

Move it right to increase delay time to a maximum of 10 seconds.



### To display or hide the Instant Replay panel

Click the Show Instant Replay button  in the the TV Tuner control panel.

## Secondary Audio Program (SAP)



The Secondary Audio Program can be used to broadcast, for example, language translations, reading services for the visually impaired, weather forecasts, or information about a show.

### To hear the Secondary Audio Program or to switch from stereo to mono

Click the SAP button  in the TV Tuner control panel to hear the Secondary Audio Program.

Click the SAP button again to hear monaural TV from the left channel and the Secondary Audio Program from the right channel.

Click the SAP button a third time to hear monaural TV. Clicking the SAP button again returns to stereo audio (the default).

**Note that not all television stations broadcast stereo or SAP.**

## Attaching Your TV to the ALL-IN-WONDER card

Using your ALL-IN-WONDER card, you can connect a television set as your computer's display. You can use your ALL-IN-WONDER card to do the following:

- View computer output directly on your television in either NTSC or PAL formats
- Connect using Composite or S-Video output capabilities
- Display images on both the TV and PC monitor simultaneously
- Provide a big-screen experience for entertainment PCs that is ideal for playing games, giving presentations, watching movies, and browsing the Internet

To connect your computer to a television, simply attach a connector cable (S-Video or Composite) from the television to your ALL-IN-WONDER. S-Video will produce the best results. You can also connect a VCR to your ALL-IN-WONDER card to record presentations (for example) on videotape.

### To connect your graphics card to a television

- 1 Turn off your computer and your television.
- 2 Determine if your television has an S-Video connection or an RCA video-in connection.
- 3 Looking at the back of your computer, locate your graphics card (see diagram below).

#### ALL-IN-WONDER Connectors

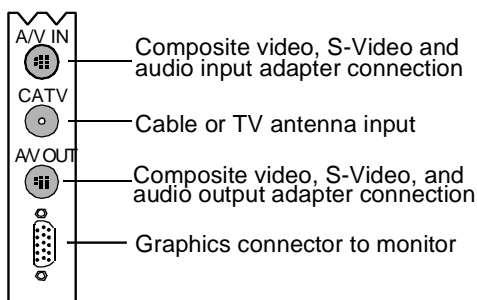

- 4 Connect the supplied output cable adapter to the A/V OUT connector on the ALL-IN-WONDER.

- 5 Using a cable with either S-Video or RCA connectors, attach one end of the cable to the output cable adapter and the other to your television.
- 6 Turn on your computer and your television.

*If there is no display, you may need to enable the television output capability.*

*For detailed cabling diagrams and audio connections, see [Input and output adapters](#) on page 18.*

**NOTE**

*You must attach a TV before enabling TV output.*

**To enable the television display**

- 1 Click Start.
- 2 Point to Settings.
- 3 Click Control Panel.
- 4 Double-click Display.
- 5 Click the Settings tab.
- 6 Check the Television checkbox to enable the television display.

*For more information about television display, click [Help](#).*

## Setting up ATI VIDEO PLAYER

ALL-IN-WONDER's default settings should work well for most uses. You can also use the Setup dialogs to fine-tune the settings for your particular purposes.

When you click the Setup button  in the Task control panel, you can choose a dialog to set up the following (some dialogs only appear in certain modes):

<b>Display</b>	<p><b>Sets up the display's general appearance and functions.</b></p> <ul style="list-style-type: none"> <li>• Adjust panel size.</li> <li>• Set panel snap-to grid location and always-on-top.</li> <li>• Turn bubble help on/off.</li> <li>• Turn fixed aspect ratio on/off.</li> <li>• Assign a Hotkey to hide the player.</li> <li>• Replace your desktop pattern with live TV.</li> </ul>
<b>Still Capture</b>	<p><b>Controls how still frames are captured. Where applicable, you can specify where to store them.</b></p> <ul style="list-style-type: none"> <li>• Capture still frames to the clipboard, to a numbered file (for example, image01.bmp, image02.bmp, etc.), or to a window.</li> <li>• Specify printer options for the captured images.</li> <li>• Specify scaling, image quality and size.</li> </ul>
<b>Video</b>	<ul style="list-style-type: none"> <li>• Adjust color, tint (NTSC video only), contrast, and brightness.</li> <li>• Select input connector (TV, composite, or S-Video).</li> <li>• Select broadcast standard: NTSC, PAL, SECAM (this feature is enabled only on selected boards).</li> <li>• Display one field, both fields, or interlaced.</li> </ul>
<b>TV Tuner</b>	<ul style="list-style-type: none"> <li>• Autoscan for active channels and add them to a list.</li> <li>• Add, delete, and name channels in the list.</li> <li>• Select antenna or cable input and cable standard.</li> <li>• Use slider to change channel assignments.</li> <li>• Lock out selected channels.</li> </ul>
<b>Closed Caption (NTSC video only)</b>	<ul style="list-style-type: none"> <li>• Display closed captioned text over live video, in its own window, or not at all.</li> <li>• Select solid or shaded background for text.</li> <li>• Transcribe closed captioned text to a text file.</li> </ul>

<b>Hot Words (NTSC video only)</b>	<ul style="list-style-type: none"> <li>• Enable/disable Hot Words in the Closed Captioning.</li> <li>• Add or change Hot Word selection.</li> <li>• Set Hot Words to start transcribing automatically.</li> </ul>
<b>Capture</b>	<ul style="list-style-type: none"> <li>• Select frame rate.</li> <li>• Select video format and video compression type.</li> <li>• Capture audio and select audio format.</li> </ul>
<b>Advanced</b>	<ul style="list-style-type: none"> <li>• Capture to memory or disk.</li> <li>• Limit capture to pre-set amount of time.</li> <li>• Pre-allocate maximum file size.</li> </ul>
<b>MPEG</b>	<ul style="list-style-type: none"> <li>• Select scale in frames or time.</li> <li>• Update the slider position.</li> <li>• Play CD automatically if present.</li> </ul>
<b>Audio CD</b>	<ul style="list-style-type: none"> <li>• Display the disc tracks and the current Play List.</li> <li>• Add or remove tracks in the Play List.</li> <li>• Enter the artist's name and disc title.</li> </ul>
<b>Program Lockout</b>	<ul style="list-style-type: none"> <li>• Set passwords for Program Lockout, Access Program Lockout page, Access Locked Program, Access Channel Organizer, Tuner panel Double Lockout, and Channel Double Lockout.</li> </ul>
<b>TV Magazine</b>	<ul style="list-style-type: none"> <li>• Specify image layout.</li> <li>• Convert characters to upper- or lower-case.</li> <li>• Save images as black &amp; white.</li> <li>• Specify the number of lines of captioning per picture.</li> <li>• Remove advertisements.</li> </ul>
<b>Scheduled Viewing</b>	<ul style="list-style-type: none"> <li>• List scheduled events.</li> <li>• Specify schedule times.</li> <li>• Select file playback, watch TV, or play CD.</li> <li>• Display in full screen.</li> <li>• Transcribe closed-captioned text.</li> <li>• Disable scheduled events.</li> <li>• Close the Player.</li> <li>• Enter a new event.</li> <li>• Remove selected events or all events from the schedule.</li> </ul>

## Setting up the TV tuner

Perform the following simple steps to set up the TV:

### Choose antenna or cable

- 1 Click the Setup button  in TV Tuner mode.
- 2 Click the TV Tuner tab.
- 3 From the list box, select the TV broadcast format (Antenna, Cable, HRC cable, or IRC cable).

### Set up the audio

*Select the sound card connector used for TV audio input:*

- 1 Click the Setup button  in TV Tuner mode.
- 2 Click the Video tab.
- 3 Click the Audio Input scroll box.
- 4 Select a sound card connector from the drop-down list.

### Scan for available channels

- 1 Click the Setup button  in TV Tuner mode.
- 2 Click the TV Tuner tab
- 3 Click the Auto Scan button in the TV Tuner setup dialog.

The TV Tuner scans for all available channels and stores them when you click the Set button. When scanning is complete, you can type in a name for each channel.

If you need additional information about these Setup dialogs, click the Help button. If you experience any difficulty setting up or running ALL-IN-WONDER, please refer to *[Troubleshooting Tips](#)* on page 63.





---

## CHAPTER 5

# Reference

This chapter contains troubleshooting tips and specifications about your ALL-IN-WONDER or ALL-IN-WONDER PRO.



### IN THIS CHAPTER...

- **Running Diagnostics** on page 62
- **Troubleshooting Tips** on page 63
- **ATI Multimedia Channel (AMC)** on page 65
- **Memory Upgrade** on page 65
- **Specifications** on page 69
- **ALL-IN-WONDER Video Mode Table** on page 70
- **Compliance Information** on page 74

## Running Diagnostics

You can run diagnostics to test the hardware on your card. All installed graphics modes can be viewed and tested. **You cannot run the diagnostics program inside a Windows MS-DOS Box.**

### To copy and run the diagnostics program in MS-DOS

- 1 Start your computer in MS-DOS mode.
- 2 Insert the *ATI Installation CD-ROM* into the CD-ROM drive.
- 3 At the MS-DOS prompt, type the following:

**XCOPY D:\UTILITY\M64DIAG.EXE c:\mach64\ /Y**  
(If **D** is not your CD-ROM drive, substitute the correct drive letter.)

*If you have not installed the ATI VIDEO PLAYER, you will need to use the DOS Make Directory command (MD) to create the **mach64** directory.*

*This copies the M64DIAG.EXE program to your hard disk.*

- 4 Type **CD C:\MACH64**.
- 5 Type **M64DIAG**.
- 6 Press ENTER to run the program.
- 7 Select Diagnostics.
- 8 Type the number of times you would like to run the tests.

## Troubleshooting Tips

The following troubleshooting tips may help you if you experience problems. Contact your dealer for more advanced troubleshooting information.

### Basic troubleshooting tips

- Check that the **card is seated properly** in its expansion slot. If the problem still exists, try a different PCI expansion slot.
- Ensure that the **monitor cable is securely fastened** to the card.
- Make sure that the **monitor and computer are plugged in and receiving power**.
- **Disable any built-in graphics capabilities** on your mother board. For more information, see your computer documentation.
- Make sure that you selected the **appropriate monitor** when you installed your enhanced driver.
- If you use an indoor antenna, you will get the best results with an **amplified** model. Place it as **far away from the PC monitor** as possible, to avoid interference.
- Make sure that your **audio card's line input is active** (see [Win95 volume control](#) on page 21).

## Windows 95 troubleshooting tips

For Windows 95 troubleshooting tips, right-click the ATI icon in the taskbar and select Troubleshooting.

If you have problems during start-up, load Windows 95 in Safe Mode.

### To load Windows 95 in Safe Mode

- 1 Turn on your computer.
- 2 Press the F8 key when **Starting Windows 95** appears on the screen.
- 3 Select Safe Mode.
  - Disable any programs that launch automatically when you start Windows 95.
  - Check that you have the correct monitor and display driver selected in the Display Properties. For more information, click Help in the Start menu.
  - Check for the existence of memory managers and ensure they are configured properly.
  - Refer to additional information in the Windows 95 README file located in the root directory on the ATI Installation CD-ROM.

### To remove the ATI VIDEO PLAYER

- 1 Click Start.
- 2 Select Settings.
- 3 Click Control Panel.
- 4 Double-click Add/Remove Programs.
- 5 Select **ATI VIDEO PLAYER** from the list.
- 6 Click Add/Remove...
- 7 Click OK.

## ATI Multimedia Channel (AMC)

While the AMC provides VGA Feature Connector (VFC) compatibility, it also provides enhanced features for new multimedia devices including serial control and provision for audio.



The AMC connector shares the same footprint with the VFC but it adds pins for supporting additional multimedia modes. Great caution should be taken when connecting a ribbon cable to the AMC/VFC connector. Some of the pins carry power and any improper use can result in damage both to the graphics card and the upgrade board.

## Memory Upgrade

**ALL-IN-WONDER** If you only have 2MB of video memory on your card, you may be able to upgrade it by adding memory chips in the empty memory sockets. You may be able to add 2MB of memory to ALL-IN-WONDER, for a maximum capacity of 4MB.

**ALL-IN-WONDER PRO** You can add 4MB of memory to a 4MB ALL-IN-WONDER PRO, for a maximum capacity of 8MB.

To determine the type and amount of memory you have on your card, do the following:

- 1 Right-click My Computer.
- 2 Click Properties.
- 3 Click the Device Manager tab.
- 4 Click the plus sign to the left of Display Adapters.
- 5 Double-click ATI ALL-IN-WONDER or ALL-IN-WONDER PRO.
- 6 In the dialog that appears, click Diagnostics.
- 7 Click the Status button.

The Video Memory line displays the type and amount of memory on your ALL-IN-WONDER card.

Additional memory provides smoother video playback, more colors, and higher screen resolutions. Consult your monitor's specification to determine which resolutions are available with your display.

You will need the following information when upgrading your video memory:

- You need to use the same memory chip type to ensure compatibility with your card.
- Record the name of the manufacturer, the serial number, and the part number of the memory chips on your card. (See the diagram on the following page to determine your memory chip location.)

**ALL-IN-WONDER** *Memory Type* (256 Kbits x 16)

*Package* — EDO

*Speed* — 60 nanosecond cycle time or faster

*Quantity* — 4 chips (to add 2MB)

To order additional memory chips, please contact your dealer.

**ALL-IN-WONDER PRO** *Memory Type* (256 Kbits x 32)

*Package* — SODIMM

*Speed* — 100 Megahertz cycle time or faster

*Quantity* — 1 SODIMM module (to add 4MB)

To order additional memory chips, please contact your computer dealer.

## To install additional memory



Discharge your body's static electric charge by touching a grounded surface — for example, the metal area of the computer chassis — before performing any hardware procedure.

The manufacturer assumes no liability for any damage, caused directly or indirectly, by improper installation of any components by unauthorized service personnel. If you do not feel comfortable performing the installation, consult a qualified computer technician.

Damage to system components, the accelerator card, and injury to yourself may result if power is applied during installation.

- 1 Power-off the computer and monitor.
- 2 Disconnect the monitor cable from the back of the computer.
- 3 Remove the computer cover. If necessary, consult your computer system manual about removing the cover.
- 4 If your card has been previously installed, remove it from the computer.
- 5 Place your card on a flat surface.
- 6 Find pin 1 on the memory chip using the following three diagrams as a guide:

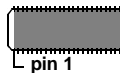

*The chip may have a beveled edge.*



*The chip may have a notch.*



*The chip may have a dot.*

- 7 Find pin 1 in the empty memory socket on your card. Use the following diagram as a guide

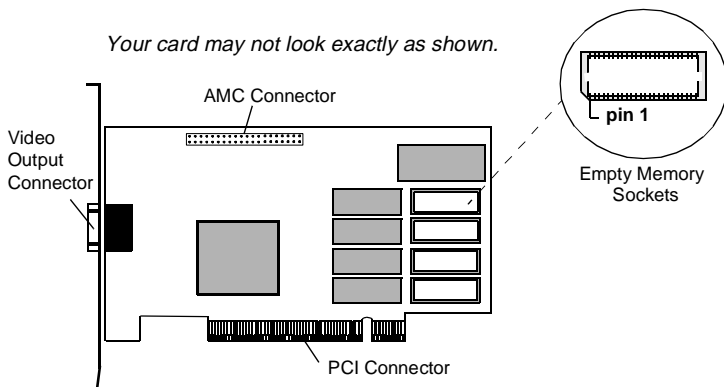

When installing memory chips, use care to ensure that every pin is properly seated in the socket and that pin 1 is correctly oriented. If you are unsure of this procedure, please contact a professional technician to aid in the installation.

- 8 Align pin 1 of the memory chip with pin 1 in the empty memory socket.
- 9 Insert the chip into the socket and seat it firmly to ensure good contact.
- 10 Repeat steps 6 to 9 to install the other memory chips.
- 11 Re-install the card and the computer cover. For more information, see [Hardware Installation](#) on page 13.
- 12 Plug the monitor into your card.
- 13 Turn on the computer and monitor.
- 14 To ensure that your video memory is working properly, run the diagnostics program and select Configuration. For more information, see [Running Diagnostics](#) on page 62.



# Specifications

System Requirements — Pentium/Pentium Pro, or compatible systems with PCI Local Bus.

## *Operating Environment*

- Windows 95  
*Only graphics features are supported under DOS 5.0 or higher, Windows 3.1x, Windows NT, OS/2 2.1 or OS/2 Warp*

## *Video Display Buffer*

- **ALL-IN-WONDER** • 2 MB non-upgradable,  
• 2 MB upgradable to 4 MB, • or 4 MB

- **ALL-IN-WONDER PRO** 4MB, upgradable to 8MB.

## *Sync Signals*

- Separate horizontal and vertical sync at TTL levels

## *Video BIOS*

- PCI 2.1 compliant

## *Video Output Connector*

- 15-pin D shell (Female), IBM standard.

## *AMC Connector*

- 2x20 pin header. Shares the same footprint with the 2x13 pin VGA Feature Connector, VGA Out only, VESA standard.

## *Video interrupt (Reserved for future use):*

- PCI — system auto-configurable, jumper-settable (default is OFF).

## *Power*

- +5V  $\pm 5\%$ , @ 1.3A typical.

## *Ambient Temperature*

- Operating — 50° to 122° F (10° to 50° C).
- Storage — 32° to 162° F (0° to 70° C).

## *Relative Humidity*

- Operating — 5% to 90% non-condensing.
- Storage — 0% to 95%.

## *MTBF*

- 120,000 hours.



ALL-IN-WONDER Video Modes											
Display Screen Resolution	Refresh Rate (Hz)	Hor. Scan (kHz)	Pixel Clock (MHz)	Colors (Bits Per Pixel)							
				2 MB				4 MB			
				8	16	24	*32	8	16	24	*32
1280x1024	47	50.0	80.0	•	•	•		•	•	•	
1280x1024	60	64.0	110.0	•	•	•		•	•	•	
1280x1024	70	74.6	126.0	•	•	•		•	•	•	
1280x1024	74	77.9	135.0	•	•	•		•	•	•	
1280x1024	75	80.0	135.0	•	•	•		•	•		
1280x1024	85	91.2	157.5	•	•			•	•		
1280x1024	90	96.2	160.0	•	•			•	•		
1280x1024	100	106.4	172.0	•	•			•	•		
1600x1200	52	68.0	135.0	•				•	•		
1600x1200	58	75.0	135.0	•				•	•		
1600x1200	60	76.2	156.0	•				•	•		
1600x1200	72	89.7	194.4	•				•	•		
1600x1200	75	93.8	202.0	•				•	•		

\*32 - 24bpp color data is processed using a 32bpp data format.



<b>ALL-IN-WONDER PRO Video Modes</b>																
Display Screen Resolution	Refresh Rate (Hz)	Hor. Scan (kHz)	Pixel Clock (MHz)	Colors (Bits Per Pixel)												
				2 MB				4 MB				6 MB or 8 MB				
				8	16	24	*32	8	16	24	*32	8	16	24	*32	
1280x1024	47	50.0	80.0	*	*	*		*	*	*		*	*	*	*	
1280x1024	60	64.0	110.0	*	*	*		*	*	*		*	*	*	*	
1280x1024	70	74.6	126.0	*	*	*		*	*	*		*	*	*	*	
1280x1024	74	77.9	135.0	*	*	*		*	*	*		*	*	*	*	
1280x1024	75	80.0	135.0	*	*	*		*	*	*		*	*	*	*	
1280x1024	85	91.2	157.5	*	*	*		*	*	*		*	*	*	*	
1280x1024	90	96.2	160.0	*	*	*		*	*	*		*	*	*	*	
1280x1024	100	106.4	172.0	*	*	*		*	*	*		*	*	*	*	
1600x1200	52	68.0	135.0	*	*	*		*	*	*		*	*	*	*	
1600x1200	58	75.0	135.0	*	*	*		*	*	*		*	*	*	*	
1600x1200	60	76.2	156.0	*	*	*		*	*	*		*	*	*	*	
1600x1200	72	89.7	194.4	*	*	*		*	*	*		*	*	*	*	
1600x1200	75	93.8	202.0	*	*	*		*	*	*		*	*	*	*	
1600x1200	85	106.2	229.5	*	*	*		*	*	*		*	*	*	*	

\*32 - 24bpp color data is processed using a 32bpp data format.

# Compliance Information

## FCC Compliance Information

ALL-IN-WONDER complies with FCC Rules Part 15. Operation is subject to the following two conditions:

- This device may not cause harmful interference, and
- This device must accept any interference received, including interference that may cause undesired operation.

This equipment has been tested and found to comply with the limits for a Class B digital device, pursuant to Part 15 of the FCC Rules. These limits are designed to provide reasonable protection against harmful interference in a residential installation. This equipment generates, uses and can radiate radio frequency energy and, if not installed and used in accordance with manufacturer's instructions, may cause harmful interference to radio communications. However, there is no guarantee that interference will not occur in a particular installation. If this equipment does cause harmful interference to radio or television reception, which can be determined by turning the equipment off and on, the user is encouraged to try to correct the interference by one or more of the following measures:

- Re-orient or relocate the receiving antenna.
- Increase the separation between the equipment and receiver.
- Connect the equipment to an outlet on a circuit different from that to which the receiver is connected.
- Consult the dealer or an experienced radio/TV technician for help.

- The use of shielded cables for connection of the monitor to the graphics card is required to ensure compliance with FCC regulations.
- Changes or modifications to this unit not expressly approved by the party responsible for compliance could void the user's authority to operate this equipment.

## Industry Canada Compliance Statement

ICES-003 This Class B digital apparatus meets all requirements of the Canadian Interference-Causing Equipment Regulations.

Cet appareil numérique de la Classe B Respecte toutes les exigences du Règlement sur le matériel brouiller du Canada.

## CE Compliance Information

EMC Directive 89/336/EEC and Amendment 92/31/EEC, Class B Digital Device

EN 5008-1, Generic Emissions Standard for Residential, Commercial and Light Industrial Products

(EN 55022/CISPR 22, Limits and Methods of Measurement of Radio Interference Characteristics Information Technology Equipment)

*Warning: This is a Class B product. In a domestic environment this product may cause radio interference in which case the user may be required to take adequate measures.*

EN 50082-1, Generic Immunity Standard for Residential, Commercial and Light Industrial Products

(IEC 801-2, IEC 801-3, IEC 801-4)

Directive EMC 89/336/CEE et amendement 92/31/CEE, dispositif numérique de Classe B

EN 50081-1, Norme sur les émissions génériques pour les produits domestiques, commerciaux et industriels légers

(EN 55022/CISPR 22, Limites et méthodes de mesure des caractéristiques d'interférences radiophoniques, Matériel des technologies de l'information) *Mise en garde: ceci est un produit de Classe B. Il risque produire des interférences radiophoniques dans un environnement domestique auquel cas l'utilisateur peut se voir demandé de prendre des mesures adéquates.*

EN 50082-1, Norme sur l'immunité générique pour produits domestiques, commerciaux et industriels légers.

(CEI 801-2, CEI 801-3, CEI 801-4)

EMC Richtlinie 89/336/EEC und Änderung 92/31/EEC, Digitale Gerat der Klasse B

EN 50081-1, Allgemeiner Emissions-Standard fur Haushalt- und kommerzielle Produkte sowie Erzeugnisse der Leichtindustrie

(EN 55022/CISPR 22, Beschrankungen und Verfahren der Messung von informationstechnischen Ausrustungen mit Funkstormerkmale)

*Warnung: Dies ist ein Erzeugnis der Klasse B. Dieses Erzeugnis kann Funkstorungen im Wohnbereich verursachen; in diesem Fall konnen entsprechende Manahmen seitens des Benutzers erforderlich sein.*

EN 50082-1. Allgemeiner Unempfindlichkeits-Standard fur Haushalt- und kommerzielle Produkte sowie Erzeugnisse der Leichtindustrie

(IEC 801-2, IEC 801-3, IEC 801-4)

